

**TEXAS PARKS AND WILDLIFE**

# **WILDLIFE MANAGEMENT ACTIVITIES AND PRACTICES**

## **COMPREHENSIVE WILDLIFE MANAGEMENT PLANNING GUIDELINES**

for the

**High Plains and Rolling Plains  
Ecological Regions**

Revised  
April 2010



## The following Texas Parks & Wildlife Department staff has contributed to this document:

Kirby Brown, Private Lands and Habitat Program Director (Retired)  
Gene Miller, Technical Guidance Biologist, Canyon  
Ruben Cantu, Regional Director, Region 1, San Angelo  
Linda Campbell, Program Director, Private Lands & Public Hunting Program, Austin  
Linda McMurry, Private Lands and Public Hunting Program Assistant -- Austin

### *With Additional contributions from:*

Terry Turney, Rare Species Biologist, San Marcos  
Trey Carpenter, Manager, Granger Wildlife Management Area  
Dale Prochaska, Private Lands Biologist, Kerr Wildlife Management Area  
Nathan Rains, Private Lands Biologist, Cleburne



## TABLE OF CONTENTS

### Comprehensive Wildlife Management Planning Guidelines High Plains & Rolling Plains Ecological Regions

#### INTRODUCTION

##### Specific Habitat Management Practices, by Activities

HABITAT CONTROL  
EROSION CONTROL  
PREDATOR CONTROL  
PROVIDING SUPPLEMENTAL WATER  
PROVIDING SUPPLEMENTAL FOOD  
PROVIDING SUPPLEMENTAL SHELTER  
CENSUS

#### APPENDICES

APPENDIX A: General Habitat Management Considerations, Recommendations, and Intensity Levels  
APPENDIX B: Determining Qualification for Wildlife Management Use  
APPENDIX C: Wildlife Management Plan Overview  
APPENDIX D: Livestock Management Recommendations  
APPENDIX E: Vegetation Management Recommendations  
APPENDIX F: General Population Management Recommendations for Big Game  
APPENDIX G: Specific Management Recommendations for WT/Mule Deer  
APPENDIX H: A Strategy for Management of Wildlife Openings in the Rolling Plains.  
APPENDIX I: Upland/Small Game Population & Harvest Recommendations  
APPENDIX J: Specific Management Recommendations for Bobwhite Quail  
APPENDIX K: Guidelines for Native Grassland Restoration  
APPENDIX L: Effects of Quail Management on Nongame Species  
APPENDIX M: Specific Management Recommendations for Rio Grande Turkeys  
APPENDIX N: Managing Riparian Habitat for Wildlife in Northwest Texas  
APPENDIX O: Guidelines for Woody Plantings to Restore/Enhance Riparian Zones  
APPENDIX P: Wildlife Considerations in the Management of CRP Lands  
APPENDIX Q: Native Brush Establishment on Rangeland for Wildlife  
APPENDIX R: Establishing Shelterbelts for Wildlife  
APPENDIX S: Comments Concerning Federally Listed T & E Species  
APPENDIX T: Nongame Wildlife Recommendations  
APPENDIX U: Wildlife Watering Facilities  
APPENDIX V: Trapping Brown-headed Cowbirds  
APPENDIX W: Forms  
APPENDIX X: References  
APPENDIX Y: Wildscapes Native Plant List and Bibliography  
APPENDIX Z: Learn About Whitetails  
APPENDIX AA: Learn About Turkey  
APPENDIX BB: Bobwhite Quail in Texas  
APPENDIX CC: West Texas Mule Deer  
APPENDIX DD: Pesticides and Brush Control  
APPENDIX EE: Lesser Prairie Chicken

# COMPREHENSIVE WILDLIFE MANAGEMENT PLANNING GUIDELINES

## *for the*

### High Plains & Rolling Plains Ecological Regions

*(Prepared in partial fulfillment of the requirements of HB 1358 - Wildlife Management Property Tax Valuation and HB3123 - relating to the standards for determining whether land qualifies for appraisal for ad valorem tax purposes as open-space land based on its use for wildlife management.)*

#### **Introduction**

The Texas Constitution and the legislature provides those landowners with a current 1-d-1 Agricultural Valuation (often known as an Ag Exemption) an opportunity to change from a traditional qualifying agricultural practice to wildlife management as a qualifying agricultural practice while maintaining the current valuation. HB 1358 by Representative Clyde Alexander provided that the landowner must implement and complete at least one management practice from at least three of the seven wildlife management activities listed in **Appendix A**. Most landowners interested in wildlife can meet this requirement, and implement several practices beyond the minimum required.

The 2001 legislative session passed HB3123, co-sponsored by Representative Bob Turner and Representative Clyde Alexander. This bill provided for further clarification of the standards required for determining whether land qualifies for appraisal as open-space land based on wildlife management. As a result of HB3123, more uniform standards of qualifying for wildlife management have been applied statewide.

#### **Wildlife Management Tax Valuation**

Land that qualifies for an agricultural valuation is appraised on its productivity value rather than on its market value. While many people refer to such land as having an “ag exemption”, in fact there is no such exemption—it is just a different method of calculating the land’s value for ad valorem tax purposes. Correctly speaking such land has an agricultural valuation.

Under Texas law, wildlife management is legally nothing more than an additional qualifying agricultural practice people may choose from in order to maintain the agricultural valuation on their land. Just as there is no real ag “exemption”, there also is no wildlife “exemption”. Wildlife management is not an additional appraisal, nor is it separate from “traditional” agriculture. For ad valorem tax purposes wildlife management is agriculture. There is no change in the ad valorem tax valuation with wildlife management, only a change in the qualifying agricultural practice.

#### **Acreage Requirements**

There are no minimum acreage requirements unless since the previous tax year the landowner has sold, gifted, or otherwise reduced the size of their ag appraised property; the landowner has purchased or otherwise acquired property that has been partitioned out of a larger agriculturally qualified tract. When either a change in ownership or tract size occurs, the minimum acreage requirements apply.

Landowners acquiring property that has been partitioned out of a larger qualifying tract

since the previous tax year, and those who have reduced the size of their property need to be certain that the property will meet the minimum size as set by the county. Refer to **Appendix B** for the maximum and minimum acreages by region, and to your county Central Appraisal District office for the minimum acreage size adopted. It is important to note that regardless of the property size, it must still be appraised for open-space use before it is eligible to change over to wildlife management use.

When a qualifying tract of land is broken into smaller tracts and sold, the standards for minimum eligible tract size take effect. These sizes are determined by location within the state. Within each area, the county has the ability to choose within a specified range the minimum qualifying acreage. Tracts below this minimum size are not eligible to manage for wildlife as their agricultural practice for ad valorem tax purposes. The exception is for landowners who are buying property in a Wildlife Management Property Owners' Association. Wildlife management property owners associations are community developments similar to wildlife management co-ops, but differ in that each person buying into the neighborhood must make a legal commitment to practice a certain level of wildlife management. Deed restrictions, conservation easements, property owner agreements, or other legally binding covenants insure that the habitat for wildlife is protected and managed in exchange for landowners being able to maintain an agricultural valuation based on wildlife management. If such legally binding covenants exist, the county may set a 1% or 2% lower minimum acreage requirement.

These same lower minimum acreages also apply to landowners who have habitat for threatened or endangered species or a species of concern. While the actual presence of the species on the property is not required, a qualified wildlife professional must verify that the habitat for the species does in fact exist on the property before this exception is granted by the county.



Although landowners with smaller tracts of land are encouraged to work cooperatively with their neighbors for some wildlife management practices, such as conducting a population census, each landowner must also individually be doing three practices of an appropriate intensity level on their property, submit their own individual wildlife management plan and be able to qualify on their own.

### **The Wildlife Management Plan**

This guide is intended to provide landowners with information to develop their own plans. The plan may be as simple or as extensive as the landowner chooses. The practices described in this guide are intended only as guidelines. Certain site-specific situations may necessitate changes that can be allowed, if based on trained resource professionals' recommendations.

All landowners are required to develop and submit a wildlife management plan to the county Central Appraisal District along with their 1-d-1 Open Space Appraisal

Application. All wildlife management plans must be on the form provided by Texas Parks & Wildlife Department. This form, PWD 885-W7000, is included in **Appendix W**.

While a comprehensive and highly detailed written wildlife management plan as described in these guidelines is not required by the county, it is highly recommended that the landowner go through this lengthier exercise and use this lengthier plan as a guide when filling out the required PWD 885-W7000 wildlife management plan form. The plan must address a separate practice in at least three of the seven wildlife management categories.

A wildlife management plan describes historic and current land use practices, establishes landowner goals and objectives (also family goals if desired) for the property, and describes specific activities and practices designed to benefit wildlife species of interest and their habitats. **This is the landowner's plan**, designed by the landowner, with the possible assistance of a wildlife biologist of the Texas Parks and Wildlife Department [TPWD], Texas Cooperative Extension, USDA Natural Resources Conservation Service [NRCS, formerly Soil Conservation Service - SCS], Texas Forest Service [TFS], or other qualified wildlife biologist. Efforts to perform activities identified in the plan are completely voluntary on the part of the landowner, except those practices that are necessary to maintain the agricultural appraisal for wildlife management use.

A complete plan will likely include elements of all seven listed wildlife management activity categories. While Texas Parks and Wildlife Department biologists are available to assist landowners in developing a wildlife management plan for ad valorem tax purposes, it should be noted that the Department's participation is not required in order for the wildlife management plan to be valid.

### **What Paperwork to File**

All paperwork for changing the land's qualifying agricultural practice over to wildlife management must be filed with the Chief Appraiser at the county's Central Appraisal District. No paperwork is required to be filed with Texas Parks and Wildlife Department. Landowners will need to complete a 1-d-1 Open Space Appraisal Application available from their Central Appraisal District and attach to it the completed PWD 885-W7000 wildlife management plan that is included in **Appendix W**.



*With 95% of Texas privately owned, the wildlife that belongs to the people of Texas depends on private landowners to voluntarily provide them with quality habitat.*

# Habitat Control

Grazing Management  
Prescribed Burning  
Range Enhancement  
Brush Management  
Riparian Management and Enhancement  
Wetland Enhancement  
Habitat Protection for Species of Concern  
Prescribed Control of Native, Exotic, and Feral Species  
Wildlife Restoration

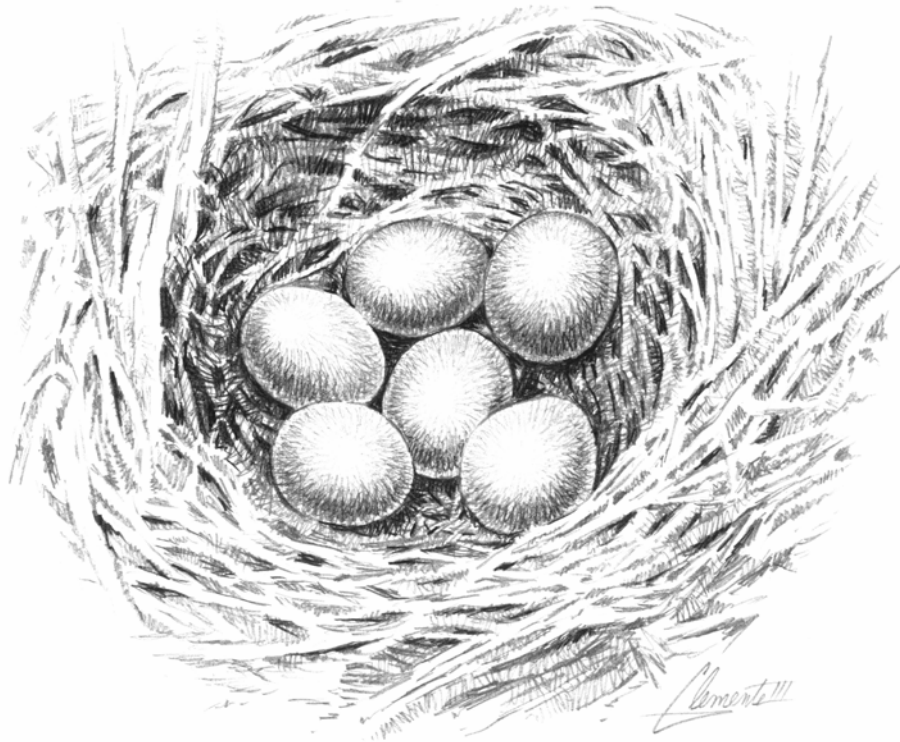

## HABITAT CONTROL (HABITAT MANAGEMENT)

### Introduction

Habitat is defined as the physical and biological surroundings of an organism and provides everything that a living organism needs to survive and reproduce. The three basic requirements of any wildlife species to survive and reproduce are food, water, and shelter. Quite frequently, we as land managers tend to focus on a specific wildlife species and its needs as opposed to the habitat or community in which they live. The key to managing wildlife and our natural resources is to use a comprehensive approach and promote healthy ecosystems. Single species deserve less attention, while the system in which they thrive requires more. Knowing how a system functions, and applying the techniques with which that system developed is imperative for its continued health and existence.

Ecosystems are dynamic and continuously changing. Succession is the change in plant species composition and structure over time and it is succession that we as land managers are trying to manipulate. Generally the earlier the successional stage the greater the plant diversity and the greater the number of wildlife species that are benefited. This is not to say that some species are not dependant on later successional stages or even several stages. Managing for diverse native plant communities that comprise natural landscapes is important for conservation of natural biodiversity, and should be a goal of all wildlife management programs.

Aldo Leopold, who is known as the “father” of modern wildlife management in the last century authored a book in 1933 titled *Game Management*. In this textbook Leopold wrote "...game can be restored by the *creative use* of the same tools which have heretofore destroyed it - ax, plow, cow, fire, and gun." Habitat control or habitat management, as it is most often referred, is the active application of these “tools” to the land in order to promote land health and enhanced availability of the 3 basic requirements to all wildlife species. It is very important that land managers today understand basic ecological principles of plant succession; plant growth; food chains; and water, mineral and soil nutritive cycles as they affect range, wildlife, and grazing management. This not only produces high quality habitat and animals, but also can lead to more stable conditions during stress periods such as droughts and winter.

### Grazing Management

People often view grazing livestock as being incompatible with managing for wildlife; however, planned grazing can be beneficial to wildlife habitat. Focusing on good land management as opposed to strictly livestock production allows a landowner to adjust the presence or absence of livestock as well as a grazing time and intensity level that is beneficial for both plant health and diversity.

Grasses evolved with grazing pressure. Historically great herds of bison roamed the central part of the United States and stayed constantly on the move in search of new forage and in front of predators. Bison came into an area, grazed it down, and left. Herds were never in any given area for an extended length of time. Sheer numbers of bison in the herd did not allow the animals to be selective about plants that were bitten; animals were forced to eat every palatable plant in an area. This type of grazing did several things to sustain a diverse mid- and





tall-grass plant community. The intense pressure left a lot of tilled and well fertilized soil, it decreased the overall quantity of grass, allowing sunlight to reach the lower growing forbs (weeds & wildflowers), and allowed those grasses with deeper root systems to respond quicker, during the absence of bison, than those with shallower root systems. While intense for a short time period, this type of grazing provided long rest periods to native grasslands, allowing for rapid responses of annual forbs and grasses. The final result was increased plant diversity and more wildlife foods. Bison opened stands of dense grasses, providing more food for deer, turkey, quail, prairie chickens, and songbirds. With periodic grazing disturbance provided by bison herds, plant diversity and overall health of grasslands flourished. Thus, bison were a major force that shaped the ecosystem.

Europeans brought their own form of agriculture and the range appeared unlimited in its ability to support a great number and variety of livestock (cattle, sheep, goats, oxen, hogs, and horses). The demise of the bison and changes in land use patterns eventually led to fencing of open range and livestock were increasingly grazed in pastures with limited or no rest periods. Forage availability and production is dependent on stocking rates, rest, and rainfall. Sedentary grazing or limited rotation grazing with even average stocking rates and rainfall can create severely abused and overgrazed range. Grasses are continually grazed beginning with the most palatable until the plant community is primarily comprised of less desirable shallow-rooted grasses and a few undesirable forbs. Overall plant diversity decreases. An abused range lacks adequate groundcover and available browse to support healthy livestock and wildlife populations. In short, overuse by domestic livestock can cause problems in managing for healthy ecosystems.

Good grazing management starts with the basics: 1) the kind and class of livestock grazed, 2) stocking rate or intensity, 3) duration of grazing to provide rest periods for pastures, and 4) excluding livestock from sensitive areas to promote vegetation protection and/or recovery.

One grazing system is termed “high intensity, short duration.” The stocking rate is such that every plant should be bitten off once during each grazed period or rotation. Sedentary grazing allows plants to be bitten over and over starting with the most palatable first. The less desirable plants keep growing while the more palatable ones continue to get bitten. This can result in a pasture being underutilized, but still overgrazed, with the eventual result being removal of most desirable grass species. Having enough animals to bite the plants only once means livestock can only stay in one place for a short period of time before they have to be moved to another pasture. High intensity short duration grazing requires a number of pastures within the grazing system to allow for extended rest periods.

High intensity short duration grazing systems allow livestock to act as a tool to manipulate and enhance wildlife habitat and plant diversity as the bison did historically in grassland ecosystems. There are a number of variations of this system, and finding one that you are able to implement on your property is the key. If it is unrealistic to divide a property into enough small pastures to both sufficiently graze and rest the range, a small landowner may want to contact neighbors to pool property and allow each property to serve as a pasture in a grazing rotation. Properties without these options may have to use prescribed burning, strategically-timed mowing, and/or pasture aeration to achieve some of the results and benefits of grazing.

For additional information see Appendix D. Contact the Texas Parks and Wildlife Department’s Matador Wildlife Management Area at 806/492-3405 to schedule a visit and see the results of planned grazing.

## Prescribed Burning

Bison were not the only major force shaping the system in which pronghorn antelope, black bear, wolf, white-tailed deer, desert mule deer, wild turkeys, quails, prairie chickens, and a suite of grassland birds thrived historically. Fires, natural and man-made, played an integral role in managing that system. Fire is a natural ecological factor to which native vegetation is well adapted. In fact, all physiographic regions in Texas were historically prairie (fire dependent) plant communities. Since the 1850s, man has suppressed fire, and the grasslands and savannas that were once dotted with occasional mottes of trees and forests only along drainage systems are now dominated by brush and woodlands. Europeans suppressed fire to prevent damage to wooden structures, farmlands, fences, and grazing lands. In turn this eliminated or reduced the role that fire played in maintaining ecosystems that were dominated by herbaceous vegetation.



Prescribed burning is the planned application of fire to set back succession. It improves habitat and plant diversity and returns nutrients to the soil. Burning can improve accessibility for grassland birds, herptiles, big game, and domesticated grazing animals; and, increase quantity and quality of forage and browse production, suppress brush and cactus, and improve grazing distribution by removal of excessive mulch and debris. Prescribed burning is a tool used to maintain desired vegetation composition and

structure.

Achieving a management objective requires a particular set of conditions for burning and a specific type of fire or burn prescription. A burn prescription defines the range of conditions and factors under which a fire boss will light a fire to meet these specific objectives. Factors that influence the type of fire and its intensity include time of the year, fuel quantity and moisture, air temperature, humidity, soil moisture, wind speed, geographic area, and direction of the flame front movement in relation to the wind. Generally, summer fires burn hotter and winter-spring fires burn cooler. As fuel quantity goes up and fuel moisture goes down, fire intensity increases. Likewise, higher wind speed and air temperature conditions, and/or lower humidity and soil moisture conditions result in hotter burns. Fire set to move in the same direction as the wind is a headfire and fire set to move against the wind is a backfire. Headfires burn hotter than backfires.

Plant response after a fire is influenced by fire intensity, plant condition at the time of the burn, weather conditions during and after the burn, and post-burn grazing management practices. For example, forbs are prolific seed producers and valuable resource for big game and other wildlife species. Forb seedlings are highly susceptible to fire, and a late winter burn after annuals have germinated may reduce forb production for the following growing season. A winter burn is used to enhance forbs and native cool-season grasses, and is less likely to harm

deciduous trees and shrubs (hackberry, soapberry, sumacs, and oaks) than a late-summer fire used to weaken or remove honey mesquite and redberry juniper. Burned pastures can be grazed fairly soon after receipt of moisture and vegetation response for a short period in the growing season, followed by a period of planned rest for the remainder of the same season to afford time for individual grass plants to mature, produce seed, and store nutrients.

A successful prescribed burn includes 3 basic steps: 1) First, development of a burn plan which includes management goals and objectives, burn prescription, safety plan, description and map of the burn unit, smoke management, legal requirements, contacts and notifications, control and firing plan, and evaluation; 2) A safe and effective execution of the burn; and, 3) Good post-burn range, livestock, and wildlife management practices to maximize the effects of the burn. Inexperienced managers are encouraged to ask for assistance and/or advice from agencies such as Texas Parks & Wildlife or the Natural Resources Conservation Service. While instructional materials are available, it is suggested that persons new to the technique volunteer to assist on several burns conducted by experienced personnel before attempting a prescribed burn.

For additional information contact the Texas Parks and Wildlife Department's Matador Wildlife Management Area at 806/492-3405 to schedule a visit and see the effects of a good prescribed burn program and prescribed burning research.

### **Range Enhancement**

Mismanagement and overuse by livestock can lead to a degraded range condition. Continuous over-utilization by livestock and/or big game (deer) can remove nutritious and highly-palatable native plants from native range. Past land use practices such as mechanical clearing or farming may cause some plants to become rare or even nonexistent on certain ranges. Range enhancement is the re-establishment or enhancement of plant communities with native grasses and forbs. These plants provide both food and cover for wildlife and help to meet the three basic requirements.

Seeding mixes should provide for maximum native plant diversity and should include many broadleaf plants which are important forage for wildlife and seed production. Range enhancement should include appropriate plants or seed mixtures as well as methods of application for the particular ecological region where the property is located. Non-native species are not recommended for range enhancement.

Managing, restoring, and/or protecting native grass prairies is also considered range enhancement. This may or may not include actual reseeding but could include utilizing some of the "tools" to manage for the earlier successional stages of a native prairie. Grazing, burning, and mechanical disturbance (aeration) are all options to manage and restore native prairie.

### **Brush Management**

Historically, bison and fire had a huge impact on plant communities and with the removal of these major influences plant communities changed. Without fire and a high intensity short duration type grazing regime, plant communities began to see an increase in woody plant species and a change from grassland or savannah communities to more brushland or woodland habitat types. As brush continued to increase and began to form closed canopies, native plant diversity decreased. Some woody species increased at greater rates, such as redberry juniper and honey mesquite. Invasive plants like redberry juniper and honey mesquite have had a tremendous impact on the Rolling Plains ecosystem by causing an increase in soil erosion and

significantly less water absorption. Juniper brakes lose a significant amount of precipitation through transpiration and overland flow, leaving much less water for aquifer recharge to insure adequate groundwater in the future.

As mentioned before, maintenance of native plant diversity within ecological sites is the key to successful wildlife habitat management. An area that is dominated by a single species of plant is rarely going to meet the needs of wildlife. Planned use of the “tools” that Leopold described is the key to managing a property and providing the adequate amount and arrangement of brush to meet the needs of a multitude of wildlife species.

While planned grazing management and prescribed burning can reduce the need for brush management, the “axe” may be needed when a particular piece of property is beyond the point that utilizing other tools is economically feasible. Today, mechanical (grubbing, chaining, shearing) and chemical (aerial, ground, and stump treatment) methods are employed in brush management programs designed to improve native habitat, livestock forage, and hydrology.

Brush management may be only part of a good habitat management program and should be planned carefully as related to achievement of management goals. The primary principles that drive any good brush management program are: 1) extent, 2) pattern, 3) selection, and 4) method(s). The extent to which brush is going to be cleared is the first step in developing a program, and should be based on percent of woody canopy cover needed for native species common to the area. Overall habitat goals for a property should be examined to determine the amount of brush removal needed to meet wildlife, livestock and/or aesthetic expectations. Clearing 100% of the brush may be desired in order to maximize livestock production; however, if wildlife goals are important, some percent of woody canopy cover may need to be retained. Patterns in which brush is preserved should also be determined by cover needs and arrangement best suited to local native wildlife species, including seasonals (grassland birds). This may include escape, nesting, loafing, fawning, brood-rearing, and roosting cover. Maintaining travel corridors that link sections of brush may be very important. Selection includes both the ecological site (as dictated by soils) and the brush species to be cleared. The site of brush clearing is often dictated by natural topography and slope, and is a critical factor to consider so that erosion does not occur, or is kept to a minimum. Extreme care in planning should always be exercised, and highly-erodible sites are best left untreated, unless hand treatment is economically feasible in special situations, which is often not the case, depending on the scale which brush management is being conducted. Specific methods are determined by total cost analysis, soil erosion issues, and brush species being targeted.

For additional information contact the Texas Parks and Wildlife Department’s Matador Wildlife Management Area at 806/492-3405 to schedule a visit for viewing effects of brush management programs on native flora, fauna, and water conservation.

### **Riparian Management and Improvement**

Riparian areas are lands adjacent to and on either side of a stream course where vegetation is strongly influenced by the presence of water. Management or improvement of the vegetation in these areas helps to alleviate erosion, protect water quality, maintain important aquatic habitats, provide wetlands and terrestrial habitats, serve as travel corridors for wildlife, and improve aesthetic appearance. Much of the native riparian woodlands that existed historically have been cleared for agricultural production, degraded through improper timber harvest or other mismanagement, flooded by the construction of flat water reservoirs, and eliminated by dewatering of springs, streams, and creeks due to pumping for human uses (including

agricultural production) in the last century and continuing today. Timbered bottomlands (bottomland hardwood forests in the eastern part of Texas) have been referred to as a critical habitat type, and provide a wealth of benefits for wildlife, erosion control, flood control, water quality, water retention, and ecosystem health. As such, managers are encouraged to recognize, restore, and/or manage riparian areas to promote ecosystem health, plant and animal diversity, and water conservation.

Riparian management and improvements can include providing alternate livestock watering sites, deferring livestock from riparian areas during critical periods, excluding livestock from pastures with riparian areas for a specified time during and after removal of exotic invasive woody plants, herbaceous plantings or seeding in degraded riparian zones, or replanting previously cleared or degraded areas. Attention should specifically be given to protection of wild turkey roosting areas and snag retention for cavity nesters. Fencing of riparian areas as their own unit for management and use of carefully controlled, short-duration winter grazing are key tools for conservation of these fragile habitats.

### **Wetland Improvements**

It has been estimated that Texas has lost 54% of its total wetland acreage in the last 200 years. Wetlands were at one time regarded as waste-lands and nothing more than breeding grounds for insects, pests, and disease; they were considered obstacles to progress and development and were readily converted to other land uses. More recently, wetlands have been recognized as some of the most ecologically important systems on earth. Wetlands are invaluable for their ability to prevent erosion, purify water, prevent and minimize flooding, and replenish groundwater resources. They provide humans with fossil fuels and food and wildlife with invaluable habitat. Managing, protecting, restoring, or creating wetland habitat plays an integral part in a successful wildlife program.

Texas wetlands may include swamps, bottomland hardwoods, marshes, bogs, springs, playa lakes, or saline lakes. They are found along rivers, streams, lakes, and ponds; in uplands where surface water collects and at points of groundwater discharge such as springs or seeps. Wetlands are characterized by 1) water or saturated soils for at least a portion of the year, 2) plants that are adapted to wet environments (hydrophytic vegetation), and 3) soils that develop under depleted oxygen conditions (hydric soils). Managing for wetland improvement can involve any practice that enhances, restores, or creates these 3 characters. Setting back succession in an existing wetland by using the axe, cow, plow, or fire to ensure the integrity of the wetland plant community can be important to the production of wetland wildlife food sources.

Closing a ditch that was once used to drain an existing wetland or creating a ditch or drilling a water well to increase water flow into a wetland can be very important to maintaining the hydrology or flooding regime needed for that wetland to continue to function. Cleaning out a seep or spring which is experiencing reduced flow due to siltation can provide more permanent or seasonal water. And building a levee with water control structures to manage the water regime and provide water during the growing season and for fall and winter migrants can be an important habitat source for waterfowl or shorebirds.

The management options for wetlands are as diverse as the wetlands themselves. Where the opportunity exists, wetland management provides unique opportunities for habitat management that benefits a great diversity of wildlife and overall land health. Key wetlands in the High Plains are playas and saline lakes; and, riparian wetlands are valuable areas within the Rolling Plains.

### **Habitat Protection for Species of Concern**

New and changing land use practices, habitat fragmentation caused by human population growth, exclusion of fire from landscapes, and uncontrolled grazing by livestock has had negative impacts on a number of wildlife species. Endangered, threatened, or rare wildlife species are a by product of endangered and rare habitat. Habitat protection includes managing or developing additional areas to increase nesting sites, feeding areas, and other critical habitat types to overcome limiting factors and meet the three basic needs of wildlife.

Habitat protection can include setting aside critical areas of habitat, managing vegetation for a particular suite of species, and annually monitoring habitat for species of concern. Management for migrating, wintering, or breeding neotropical birds and should follow specific guidelines provided by the Texas Parks and Wildlife Department specific to your ecological region. Leopold wrote "...game can be restored by the *creative use* of the same tools which have heretofore destroyed it - ax, plow, cow, fire, and gun". Broadscale habitat management for nongame species, just as for game species, should include those practices that promote an increase in plant abundance and diversity in both composition and structure.

Contact Texas Parks and Wildlife Department for approved management guidelines before implementing activities designed to protect or enhance habitat for endangered species. For additional information see Appendix I.

### **Prescribed Control of Native, Exotic, and Feral Species**

The physical appearance and plant composition on most Texas rangelands is very different today than 200 years ago. Expansive grasslands were once dotted with only an occasional motte of trees; however, such is not the case today. Mid- and tallgrass communities have been replaced with native cool-season annual grasses and non-native grasses in many parts of Texas, including in the High Plains and Rolling Plains. Expansive native grasslands have also been replaced by invasive brush and woodlands which directly influence the wildlife species that flourish there today. The Texas white-tailed deer population is at an all time high and many ranges support more exotic and feral species now than ever before. Changing land management and demographic growth in the state, combined with grazing pressure of too many deer, exotics, and livestock have impacted wildlife habitat across the state. Over-utilized rangelands have poor plant diversity and diminished carrying capacity for wildlife and livestock due to the prevalence of exotic or lesser-quality vegetation, thus supporting a lower amount of natural diversity. There may be little or no groundcover to capture runoff, rain water is lost, and groundwater is not recharged, so the complex natural land and water system suffers. Using the gun (hunting) as a tool to maintain wildlife (big game) populations at or below the carrying capacity of the range is essential to provision of quality wildlife habitat for a multitude of wildlife species.

White-tailed deer have a high reproduction potential, and in the absence of natural predators, can quickly overpopulate range. If white-tailed deer are allowed to overpopulate, they can have negative effects on the habitat. Deer consume the most palatable plant species first, and excessive browsing pressure can eliminate preferred plant species. This reduces plant diversity and has negative impacts on many native species, most of which are not hunted. Once range is damaged by overuse from big game (deer) or livestock, vegetative recovery, even with proper management and rainfall, can take years to occur. The most effective way to regulate deer numbers is through hunting. Hunting allows the land manager to maintain deer numbers at a level that the habitat can naturally support without damage to the native plant community. In addition to habitat damage, deer on degraded ranges generally have poor fawn survival, lower

body weights, and poor antler quality. The most effective way to reduce deer numbers is through the harvest of adult females at appropriate levels. Once deer numbers are at a desired level, doe harvest must be continued to maintain the population at a desirable level.

Each time a deer hunter harvests an animal, a management decision that will affect the habitat is made. For example, doe harvest affects the sex ratio and reproductive potential of the herd. Harvest of a yearling buck affects the future age structure of the buck population. In short, the gun be used to control deer numbers, sex ratios, and age structure of the herd.

Exotic species (feral hogs and exotic ungulates) compete directly with native wildlife species for available habitat, so population reduction or elimination of these non-native species will benefit native wildlife (see Predator Control Activity for additional information on feral species).

In addition, eradication of non-native (exotic and/or invasive) vegetation that reduces natural plant diversity is highly recommended. Native plant communities always provide more productive wildlife habitat. Removal of species such as Old World bluestem, weeping lovegrass, coastal bermuda grass, salt cedar (tamarisk), Russian olive, and eastern red cedar will result in more diverse native plant communities, promote increased diversity, and will generally favor water conservaiton in the High Plains and Rolling Plains. Effective control measures for non-native vegetation are varied and specific. Landowners are encouraged to consult a local range and wildlife professional for detailed assistance or to consult web sources (TPW, Texas Cooperative Extension, USDA-NRCS, TAMU, TTU, etc.).

### **Wildlife Restoration**

Wildlife restoration has been very successful in Texas and the United States during the last century. These efforts have resulted in viable populations of beavers, wood ducks, river otters, wild turkeys, white-tailed deer, desert mule deer, pronghorn, and elk in North America. Without the aid of private landowners, these successes would not have been possible. Landowners provide trapping sites for capture of the animals to be relocated and manage habitat required for populations to thrive. In the context of these guidelines, wildlife restoration means restoring or improving habitat for targeted species as part of an overall reintroduction program in a Texas Parks and Wildlife Department approved restoration area.

# Erosion Control

Pond Construction and Repair  
Gully Shaping  
Streamside, Pond, and Wetland Revegetation  
Herbaceous and/or Woody plant Establishment on Critical Areas  
Dike/Levee Construction and Management  
Establishing Water Diversion





# Erosion Control

Any active practice that attempts to reduce or keep soil erosion to a minimum for wild animals' benefit is erosion control.

Erosion is the detachment and movement of soil by moving water, wind or ice. When raindrops hit an uncovered soil surface, they dislodge and detach soil particles (*splash erosion*). If there is more rainfall than the ground can absorb, the resulting runoff carries these detached soil particles away. Erosion is a natural process that cannot be stopped; however, human activity such as earthmoving and tillage can accelerate the process. The erosion process advances through several stages.

- **Sheet erosion** is the removal of a fairly uniform layer of soil from the soil surface by shallow overland flow.
- **Rill erosion** occurs as shallow sheet flow concentrates into small channels. Flow in these channels causes further erosion and carries soil particles away.
- **Gully erosion** is an accelerated form of rill erosion where the channels are much deeper and carry away larger quantities of soil.

Raindrop impact on bare soil surface can also form a "crust" or pan on the soil surface that can be difficult for water to infiltrate. This creates more runoff and less water available to plants, which can decrease plant growth and ground cover leading to further erosion.

According to the U.S. Department of Agriculture, the United States loses more than 2 billion tons of topsoil each year to erosion. Erosion removes fertile soil rich in nutrients and organic matter, which reduces the ability of plants to establish, grow and remain healthy in the soil. A reduction in plant growth and subsequent plant residue causes less soil cover, allowing the erosion process to perpetuate and become worse. This in turn affects the wildlife species dependent upon the affected plant communities.

## Water Quality and Conservation

Erosion not only causes loss of soil productivity but also creates water quality problems once the sediment leaves the site and enters surface waters. The EPA has declared that sediment contamination of our surface waterways is one of the biggest threats to our nation's water resources. When eroded sediment is transported from its site of origin to nearby water bodies it can also carry fertilizers, pesticides and other contaminants attached to the soil particles.

Water that is loaded with sediments can lead to reduced drainage capacity, increased flooding, decreased aquatic organism populations, decreased commercial and recreational fishing catches, clogged and damaged commercial and industrial irrigation systems, increased expenditures at water treatment plants to clean the water, and decreased recreational and aesthetic value of water resources. Some erosion control practices include:

**Pond construction** is building a permanent water pond to prevent, stop or control erosion as an approved Natural Resource Conservation Service (NRCS) watershed project while providing habitat diversity and benefiting wildlife. Whenever possible, owners should use ponds to help

create or restore shallow water areas as wetlands and for water management.

**Gully shaping** involves reducing erosion rates on severely eroded areas by smoothing to acceptable grades and re-establishing vegetation. An area should be seeded with plant species that provide food and/or cover for wildlife.

**Streamside, pond and wetland revegetation** means revegetating areas along creeks, streams, ponds and wetlands to reduce erosion and sedimentation, stabilize streambanks, improve plant diversity and improve the wildlife value of sensitive areas.

**Establishing native plants on critical areas** is one method of controlling erosion. These plants also can provide food and/or cover for wildlife and restore native habitat. Some of the ways to establish these plants are listed below.

- Establish and manage wind breaks/shelterbelts by planting multi-row shelterbelts (at least four rows that are 120 feet wide by 1/4 mile), renovate old shelterbelts (re-fence, root-prune and replace dead trees) and establish shrub mottes.
- Establish perennial vegetation on circle irrigation corners by revegetating at least every other corner to reduce erosion and sedimentation, improve plant diversity and improve wildlife habitat.
- Plant permanent vegetation on terraces and field borders to reduce erosion, improve plant diversity and improve wildlife habitat.
- Conserve tillage/no-till farming practices by leaving waste grain and stubble on the soil surface until the next planting season to provide supplemental food or cover for wildlife, control erosion and improve the soil tilth.
- Manage Conservation Reserve Program (CRP) cover by maintaining perennial cover established under the CRP on erodible sites using proper management techniques such as haying, prescribed grazing or burning.

**Dike, levee construction or management** is a way to establish and maintain wetlands or slow runoff to control or prevent erosion and to provide habitat for wetland-dependent wildlife. Levee management may include reshaping or repairing damage caused by erosion and revegetating levee areas to reduce erosion and sedimentation and stabilize levees. This practice may include fencing to control and manage grazing use.

**Water diversion** systems also can be installed to protect erodible soils and divert water into wetlands to provide habitat for resident and migratory water birds and wetland-dependent species.

### **Minimizing Erosion**

Building and construction projects can be major causes of erosion. Landowners can take steps to minimize erosion during these projects by following a few simple, commonsense precautions.

- Plan construction activities during the spring and summer months, so that erosion control measures can be in place when rain comes.
- Examine your site carefully before building. Be aware of the slope, drainage patterns and soil types. Proper site design will help you avoid expensive stabilization work.

- Preserve existing vegetation as much as possible. Limit grading and plant removal to the areas under current construction. (Vegetation will naturally curb erosion, improve the appearance and the value of your property, and reduce the cost of landscaping later.)
- Use fencing to protect plants from fill material and traffic. If you have to pave near trees, do so with permeable asphalt or porous paving blocks.
- Preserve the natural contours of the land and disturb the earth as little as possible. Limit the time in which graded areas are exposed.
- Minimize the length and steepness of slopes by benching, terracing, or constructing diversion structures. Landscape benched areas to stabilize the slope and improve its appearance.
- As soon as possible after grading a site, plant vegetation on all areas that are not to be paved or otherwise covered.
- Control dust on graded areas by sprinkling with water, restricting traffic to certain routes, and paving or graveling access roads and driveways.

### **Temporary Measures to Stabilize the Soil**

**Grass** provides the cheapest and most effective short-term erosion control. It grows quickly and covers the ground completely. To find the best seed mixtures and plants for your area, check with your local nursery, the Texas Department of Agriculture, the Natural Resource Conservation Service, the Texas Cooperative Extension Service and Texas Parks and Wildlife Department.

**Mulches** hold soil moisture and provide ground protection from rain damage. They also provide a favorable environment for starting and growing plants. Easy-to-obtain mulches are grass clippings, leaves, sawdust, bark chips and straw. Straw mulch is nearly 100% effective when held in place by spraying with an organic glue or wood fiber (tackifiers), by punching it into the soil with a shovel or roller, or by tacking netting over it. Commercial applications of wood fibers combined with various seeds and fertilizers (hydraulic mulching) are effective in stabilizing sloped areas. Hydraulic mulching with a tackifier should be done in two separate applications: the first composed of seed fertilizer and half the mulch, the second composed of the remaining mulch and tackifier. Commercial hydraulic mulch applicators - who also provide other erosion control services - are listed under "landscaping" in the phone book.

**Mats** of excelsior, jute netting and plastic sheets can be effective temporary covers, but they must be in contact with the soil and fastened securely to work effectively.

**Roof drainage** can be collected in barrels or storage containers or routed into lawns, planter boxes and gardens. Be sure to cover stored water so you don't collect mosquitoes, too. Excessive runoff should be directed away from your house and into wildlife watering facilities. Too much water can damage trees and make foundations unstable.

### **Structural Runoff Controls**

Even with proper timing and planting, you may need to protect disturbed areas from rainfall until the plants have time to establish themselves. Or you may need permanent ways to transport water across your property so that it doesn't cause erosion. To keep water from carrying soil from your site and dumping it into nearby lots, streets, streams and channels, you need ways to reduce its volume and speed. Some examples of what you might use are:

- **Riprap** (rock lining) to protect channel banks from erosive water flow.
- **Sediment trap** to stop runoff carrying sediment and trap the sediment.
- **Storm drain outlet protection** to reduce the speed of water flowing from a pipe onto open ground or into a natural channel.
- **Diversion dike or perimeter dike** to divert excess water to places where it can be disposed of properly.
- **Straw bale dike** to stop and detain sediment from small unprotected areas (a short term measure).
- **Perimeter swale** to divert runoff from a disturbed area or to contain runoff within a disturbed area.
- **Grade stabilization** structure to carry concentrated runoff down a slope

### Using Livestock to Repair the Effects of Erosion

Just as overgrazing can cause erosion, erosion can also be caused by under-utilization by livestock and permanent deferral.

Lack of grazing can cause an algal cap to develop on the surface of the soil that with time becomes impenetrable to water. A proper stocking rate keeps the soil turned over, prevents compaction, and allows rainfall to infiltrate the soil preventing run off, and reducing erosion potential.

For information on which plants provide the best erosion control and wildlife benefit, consult the Texas Plant Information Database at <http://tpid.tpwd.state.tx.us/index.asp>.



*Algal capping on the soil causes a nearly impenetrable barrier to rainfall, increasing the potential for erosion. Proper grazing helps prevent capping from occurring.*

# Predator Control

Imported Red Fire Ants  
Brown-headed Cowbirds  
Grackle, Starling, and House Sparrow Control  
Coyotes  
Feral Hogs  
Raccoons, Skunks, Feral Cats and Dogs

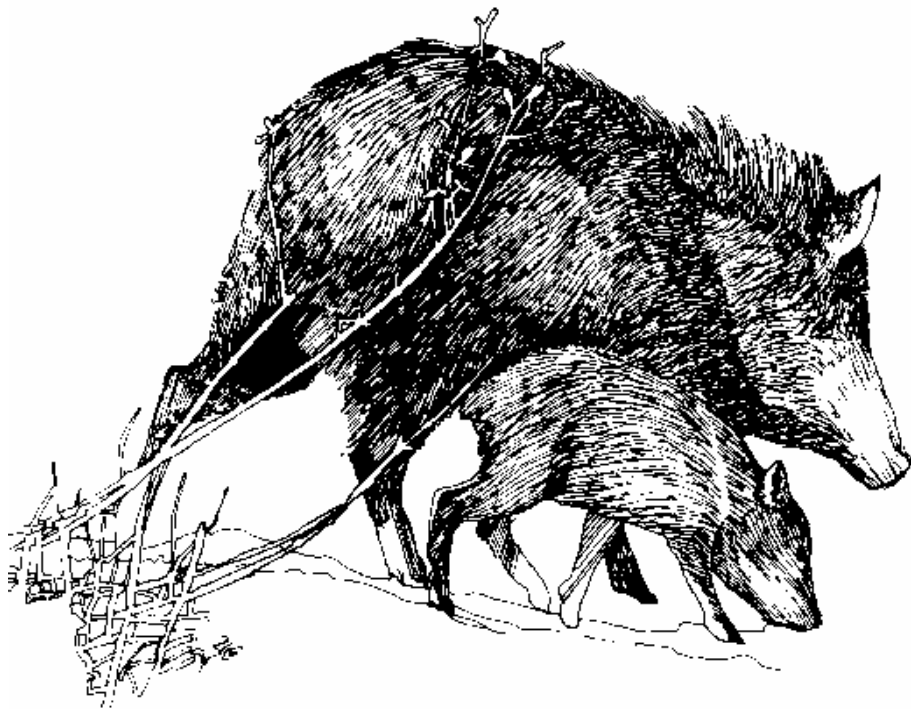

## PREDATOR CONTROL

There is no disputing the fact that predators including reptiles, birds, and mammals impact native wildlife populations. Whether that impact is negative or harmful is debated by farmers, ranchers, wildlife professionals and the general public.

Natural systems including predator – prey relationships are complex and evaluating predator impacts on native species may be difficult to say the least. Livestock injury and/or loss by predators are measurable with economic consequences and rarely tolerated by ranchers and managers. Loss of native species such as mule deer predation by mountain lions in West Texas may not be realized when in comparison to livestock but may have an economic impact on ranchers with possible lower lease returns and loss of trophy animals.

Landowners, livestock and wildlife managers should recognize the goal of predator control should be to protect livestock and minimize losses of native wildlife due to predation, not necessarily maximizing the take of predators.

Landowners and managers must evaluate the need for predator control on their property by assessing the abundance and diversity of predators present, the potential impacts by those predators on desired wildlife species and livestock, and the long-term habitat management goals of the property. For example, removing large predators from high deer density areas will only increase deer populations impacting plant diversity and cover, thus affecting the wildlife species dependant on those plants for food, shelter, and nesting cover.

It may be difficult for landowners new to an area or those not familiar with the needs of wildlife to evaluate the impacts of predators on the resident and migratory species on their property. The mere presence of some predatory species should prompt an immediate response from the landowner or manager. Feral cats, dogs, and hogs should be removed by whatever means from wildlife habitat and should not be tolerated by owners and managers. Imported red fire ants are another example of a species that should be controlled by every means available.

The Brown-headed Cowbird, a parasitic nester that impacts more than 225 species of birds, should be controlled by trapping when possible and only after attending a certification course given by Texas Parks and Wildlife Department at various times of the year.

Native predator species such as raccoons, ringtails, opossums, skunks, fox, and rat snakes can have localized impacts on resident bird populations especially ground nesting species such as turkey, quail, and a number of songbirds. Control of predators such as these may not need to be a top priority if habitat conditions are where they should be, offering abundant ground and understory cover for shelter, food and nesting.

Coyotes, bobcats, and mountain lions once considered predators of the “wilderness” are now found in close proximity to suburban areas as urban “sprawl” or expansion encroaches on rural farm and ranch lands. As property is developed into this habitat, interaction with these highly adaptable and mobile species is occurring more frequently. A common sense approach should be taken when considering control of these species. The landowner or manager must evaluate the predicted outcome of control measures prior to starting any control. For example, in many parts of the Edwards Plateau, as well as the State and nationwide, there are too many white-tailed deer and controlling the predators that feed on them would cause increased populations and further loss of habitat for other wildlife species.

Some precautions can be taken when large predators are present in an area close to people. Pets and newborn livestock should be protected by any means available i.e. fencing, enclosures, housing, etc... Keep pet foods from the outdoors and restrict wildlife feeding to a safe and comfortable distance from the house. Control of prey species numbers in the form of deer harvest to at or below carrying capacity should discourage any large predators from becoming residents in the area.

If control measures are warranted, consult with a wildlife professional prior to using any measures other than shooting or trapping. Extreme caution should be taken and only the experienced should consider methods such as poisoning.

Some species may not be recognized as predators but cause damage and loss of wildlife by actions other than direct take. For example, European Starlings and English House Sparrows displace native cavity nesting birds such as woodpeckers by taking over and actively defending nest cavities.

The presence of large grackle and blackbird colonies deter other birds from nesting in some areas. Brown-headed and Bronzed Cowbirds have tremendous impacts on songbird populations across the nation. A single female cowbird can lay up to 40 eggs per season, impacting literally hundreds of songbird species including a number of threatened and endangered species in the Edwards Plateau. Trapping and shooting are the most economic means of control with caution taken to release non-target species from traps and proper identification made prior to shooting.

A landowner or manager should first manage the wildlife habitat on his property, increasing the plant diversity and abundance of species that provide food, shelter, and nesting cover for all wildlife species prior to implementing a full scale predator control program for all predator species.

For the majority of landowners that feel predator control would be useful in meeting the criteria for H.B. 1358, the bill implemented to allow agricultural appraisal for land used to manage wildlife, a few basic practices will work. The size and location of the property, amount of wildlife habitat and the goals of the landowner will influence the practices used.

Fire ant control and cowbird trapping is not dependant on the criteria above. As well as live trapping of small and medium-sized mammals such as raccoons, opossums, rats, skunks, and others. The control of sparrows, starlings, grackles and feral animals can and should occur on any size property. On larger tracts of land, control of large predators may benefit wildlife present but should be carried out by knowledgeable land managers and/or wildlife professionals when methods other than shooting or live trapping are utilized.

On properties throughout the High Plains, Rolling Plains, and across the State, landowners and managers have implemented every known control method for predators and yet they thrive. Landowners need to have a long range wildlife management plan in place defining the goals of any of the activities occurring on the property including predator control. Once in place, activities can be monitored and results can be recorded to aid in future management decision-making.

# Providing Supplemental Water

Marsh and Wetland Restoration or Development  
Well, Troughs, Windmill Overflows, and Other Watering Facilities  
Spring Development and/or Enhancement

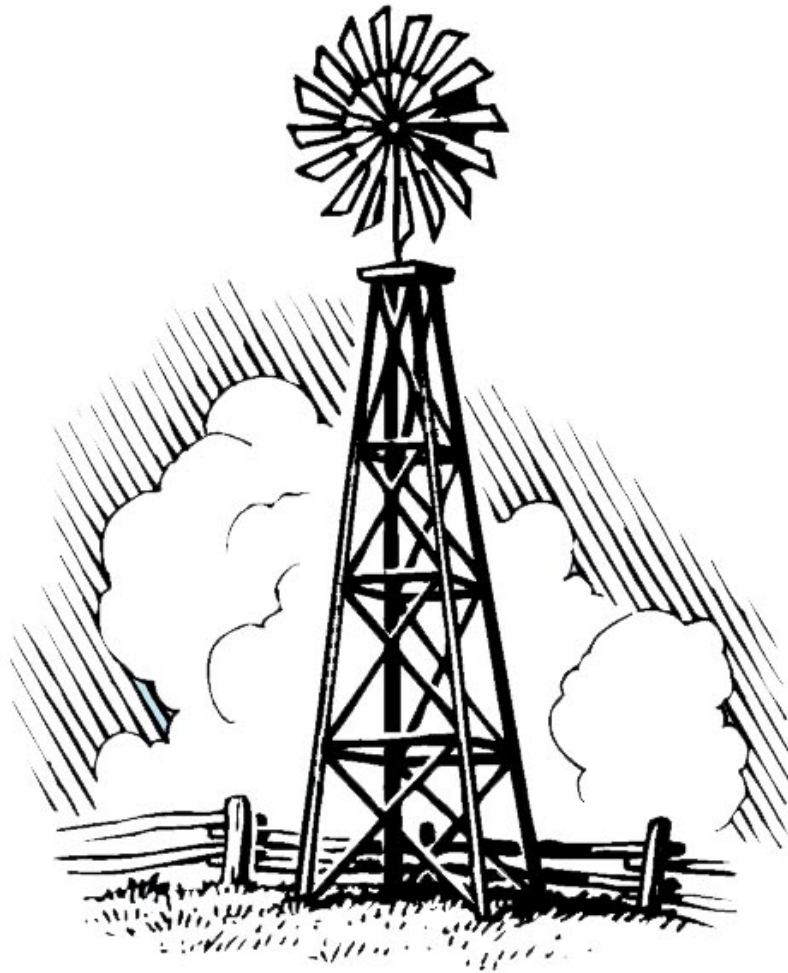



# Providing Supplemental Water

Natural water exists in all wildlife environments. Supplemental water is provided when the owner actively provides water in addition to the natural sources. This category of wildlife management activity includes providing supplemental water in habitats where water is limited or redesigning water sources to increase its availability to wildlife. Many people mistakenly believe that water sources suitable for livestock are also suitable for wildlife. Unfortunately that is not always the case, particularly for young wildlife and many bird species. Wildlife water developments are in addition to those sources already available to livestock and may require protection from livestock.

**Marsh or wetland restoration or development** can provide supplemental water in the form of shallow wetlands for wetland-dependent wildlife, even in areas where inadequate water does not limit wildlife. Owners may include seasonally available water such as:

- greentree reservoirs;
- specific shallow roost pond development;
- seasonally flooded crops and other areas;
- moist soil management;
- cienega (desert marsh) restoration, development and protection; and
- maintaining water in small (~10 acres or less) playa lakes during fall and winter by pumping.

Based on the wildlife's needs and the suitability of the property, managing water levels annually is desirable.

**Managing well, trough and windmill overflow** can provide supplemental water for wildlife and provide habitat for wetland plants. Owners also may drill wells if necessary and/or build pipelines to distribute water. Building devices—known as wildlife water guzzlers—to collect rainfall and/or runoff for wildlife in areas where water is limited also helps protect wildlife, but these devices must be a part of an overall habitat management program.

**Spring development and/or improvements** can be designed to protect the immediate area surrounding a spring. Excluding and/or controlling livestock around springs may help to maintain native plants and animal diversity. Other ways to protect areas include moving water through a pipe to a low trough or a shallow wildlife water overflow, making water available to livestock and wildlife while preventing degradation of the spring area from trampling.

Improvements also could include restoring a degraded spring by selectively removing appropriate brush and revegetating the area with plants and maintaining the restored spring as a source of wildlife water. Spring restoration work should always include appropriate consideration for maintenance of critical habitat, nesting and roosting areas for wildlife, and prevention of soil erosion, as these areas tend to be very fragile.

# Providing Supplemental Food

Grazing Management  
Food Plots  
Feeders and Mineral Supplementation  
Managing Tame Pasture, Old Fields and Croplands  
Transition Management of Tame Grass Monocultures



# Providing Supplemental Food

Most wildlife environments have some natural food. An owner supplies supplemental food by providing food or nutrition in addition to the level naturally produced on the land.

**Food plots** are one way to establish locally adapted forage to provide supplemental foods and cover during critical periods of the year. Livestock should be generally excluded from small food plots. The shape, size, location and percentage of total land area devoted to food plots should be based on the requirements of the targeted species.

**Feeders and mineral supplements** also can help dispense additional food to selected wildlife species during critical periods. These can be as simple as properly placed bird feeders, or more elaborate types of turkey feeders. Once a feeding program has been initiated, it is important to keep it implemented and insure all feeders are kept full. It is also important to clean all feeders regularly to avoid contamination from aflatoxin. Harmful aflatoxin in feed should not exceed 20 parts per billion.

Feeders for deer should not be used except to control excessive numbers of deer and/or exotic ungulates as defined within a comprehensive wildlife management plan with a targeted harvest quota that is regularly measured.

Mineral supplements also may be supplied to wildlife in several ways, however, this practice must be a part of an overall habitat management plan that addresses all animal groups and considers the habitat's carrying capacity.

**Managing tame pasture, old fields and croplands** can increase plant diversity, provide supplemental food and forage and gradually help convert the land to native vegetation. Recommended practices may include:

- overseeding or planting cool season and/or warm season legumes (for example, clovers, vetches and peas) and/or small grains in pastures or rangeland;
- using plants and planting methods appropriate to the county;
- shallow tillage (discing) that encourages habitat diversity, the production of native grasses and forbs or increases bare ground feeding habitat for selected species; and
- no till or minimum till agricultural practices that leave waste grain and stubble on the soil surface until the next planting season—which provide supplemental food or cover, control erosion and improve soil tilth.

Legumes should be planted annually until all pastures are shifted to native vegetation.

# Providing Supplemental Shelter

Nest Boxes  
Brush Piles and Slash Retention  
Fence-line Management  
Hay Meadow, Pasture, and Cropland Management for Wildlife

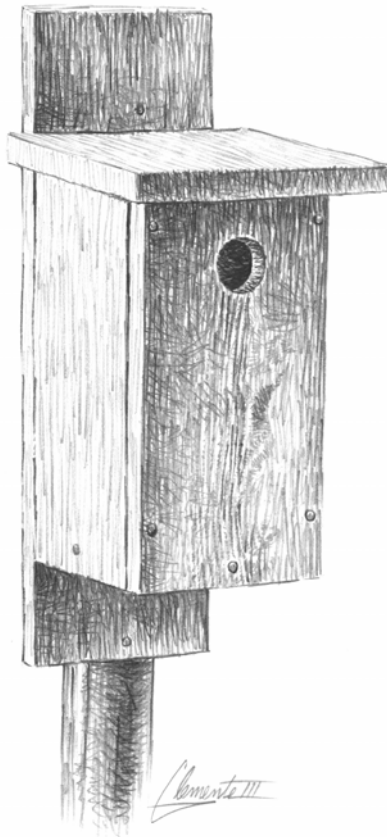

## Providing Supplemental Shelter

Cover or shelter is an important part of wildlife habitat. In fact, it is an integral part along side food and water. The arrangements of these key habitat requirements (often called juxtaposition) will often determine the success of wildlife species in a given area. Wildlife cover can take many forms and can vary greatly from one species of wildlife to another. Some species of wildlife are very specific in their need for cover while other are quite opportunistic and can readily adapt to what's available. However one thing is common when it comes to cover; they all require it.

Although supplemental shelter can be provided in many ways, it will never take the place of good conservation and management of native habitats. When land is properly managed for wildlife habitat, quality cover and shelter will usually be available. Unfortunately in much of Texas, many areas have been so altered, neglected, and abused that one of more of the key requirements of wildlife (including shelter) is absent or in short supply. This is where the opportunity exists for supplementation.

Before beginning on any wildlife management practice, you must determine what wildlife species you are managing for and what its specific needs are. Some need cover on a large scale while others may need a relatively small amount of cover. Some live and reproduce exclusively on the ground while others spend most of their lives in the air or in trees. Management should be targeted to those populations of wildlife in your area and their specific needs.

Cover and shelter can be provided for wildlife in many ways. Some species of birds and mammals nest and reproduce in cavities. Nest boxes and snags (dead, standing trees) can be created for these wildlife species. Brush piles can be created to provide cover for many species of birds, reptiles, and small mammals. Other properties lack cover on a larger scale impacting larger wildlife species such as white-tailed deer. Trees and shrubs can be planted to provide this cover requirement. Mowing can be deferred in certain areas to let grasses and weeds (forbs) grow up providing both food, cover and nesting sites for some species of wildlife. Fence lines can be allowed or encouraged to grow up in trees, shrubs, and vines in areas where cover is limited. Mesquite or other brush can be half cut early in the growing season on provide low growing, ground cover in areas where this is lacking.

# Census

Spotlight Counts  
Standardized Incidental Observations  
Stand Counts of Deer  
Aerial Counts  
Track Counts  
Daylight Deer Herd and Wildlife Composition Counts  
Harvest data Collection and Record Keeping  
Browse Utilization Surveys  
Census of Endangered, Threatened, or Protected Species  
Census and Monitoring of Nongame Wildlife Species  
Miscellaneous Counts

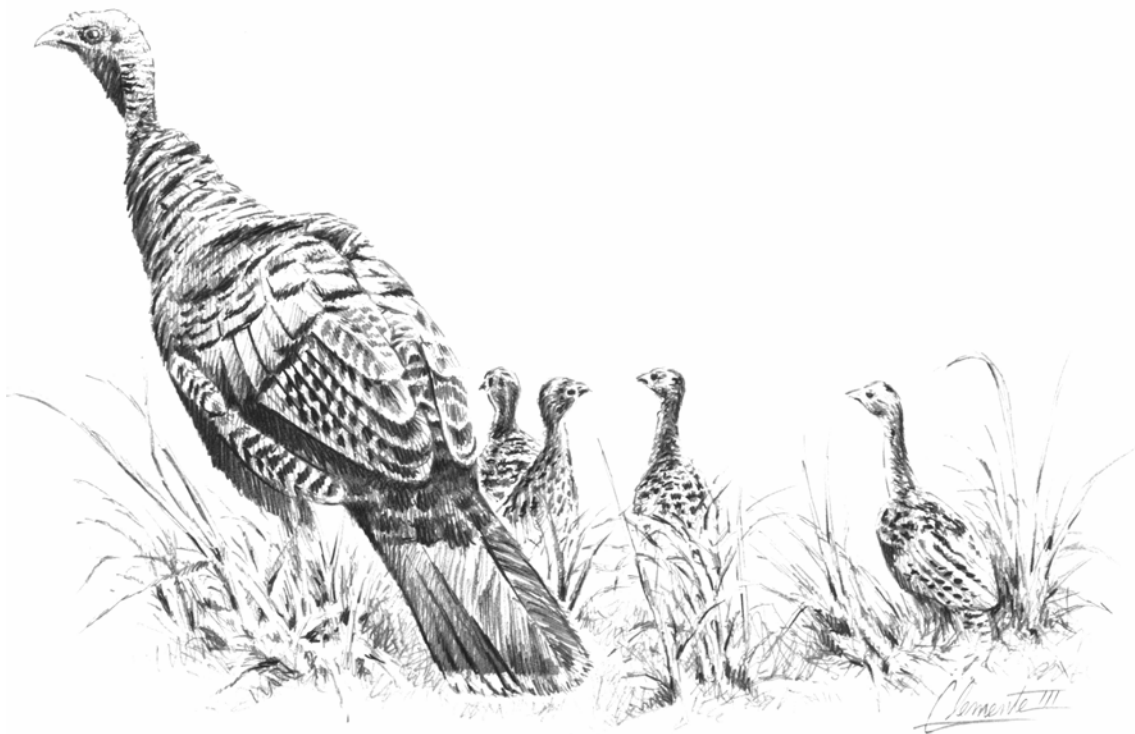

## **Census**

Census (survey) counts are periodic surveys and inventories to determine the number, composition or other relevant information about a wildlife population to measure if the current wildlife management practices are serving the targeted species. Such surveys also help evaluate the management plan's goals and practices. Specifically, this activity estimates species numbers, annual population trends, density or age structure using accepted survey techniques. Annual results should be recorded as evidence of completing this practice. (Refer to Appendices L and M for more comprehensive information on conducting census.)

**Spotlight counting** animals at night along a predetermined route using a spotlight should follow accepted methodology, with a minimum of three counts conducted annually.

**Aerial counts** using a fixed-wing aircraft or helicopter to count animals also should follow accepted methodology for the region and be performed by a trained individual.

**Daylight wildlife composition counts** are driving counts used to census wildlife in daylight hours. Annual population trends on dove, quail, turkey and deer, as well as sex/age structure on deer, should be determined by sightings along a standardized transect of a minimum of five miles at least three times during a season.

**Harvest data collection/record keeping** means tracking annual production of wildlife. Age, weight and antler development from harvested deer, and the age and sex information from game birds and waterfowl should be obtained annually.

**Browse utilization surveys** annually examine deer browse plant species for evidence of deer use on each major vegetative site on the property. The surveys should be conducted in a way that can be repeated.

**Census and monitoring of endangered, threatened or protected wildlife** through periodic counts can improve management and increase knowledge of the local, regional or state status of the species.

**Census and monitoring of nongame wildlife species** also can improve management or increase knowledge of the local, regional or state status of the species. These practices can include developing checklists of wildlife diversity on the property and should be a part of a comprehensive wildlife management plan.

One of the most important things for a landowner to remember when designing a census protocol of nongame species on their property is the ability to be consistent. In other words, be able to do the same thing in the same way at the same time each and every time the census is conducted.

# APPENDICES

## STANDARD WILDLIFE HABITAT AND POPULATION MANAGEMENT RECOMMENDATIONS

*For the*

## HIGH PLAINS & ROLLING PLAINS ECOLOGICAL REGIONS

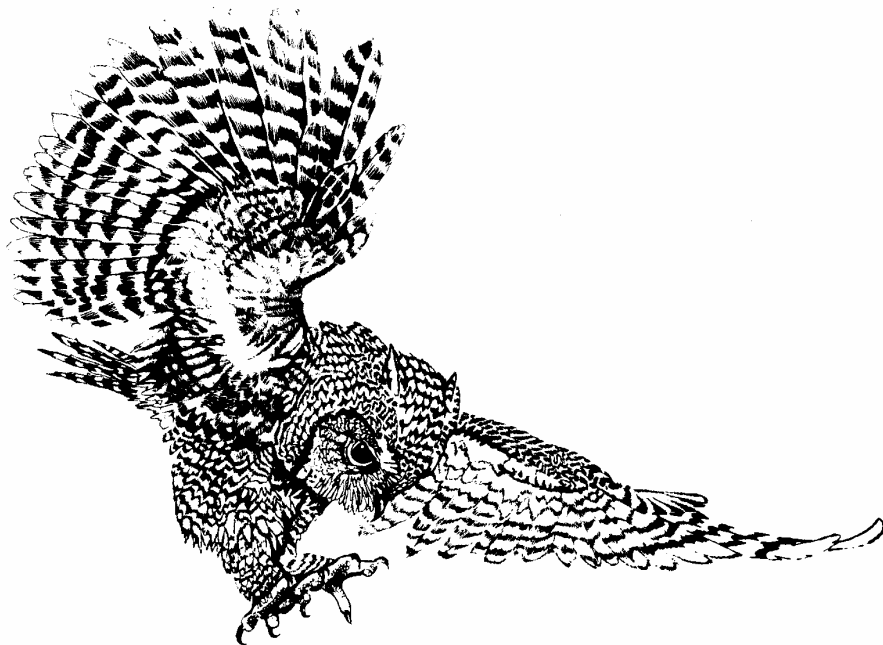



## Appendix A

# General Habitat Management Considerations, Recommendations, and Intensity Levels

Fundamental requirements which must be considered when managing wildlife habitat include food, cover, water and the proper distribution of these elements.

Wildlife and habitat management should be directed at maintaining a productive and healthy ecosystem. The ecosystem consists of the plant and animal communities found in an area along with soil, air, water and sunlight. All management activities should be aimed at conserving and improving the quantity and quality of soils, water and vegetation.

Managing for plant diversity is essential. A diverse habitat has a good mixture of various species of grasses, forbs (weeds), and browse (woody) plants. Many of these plants will be at various stages of growth, which adds another element of diversity. The diversity of vegetation increases the availability of food and cover for wildlife species. A greater diversity of plants results in more food being made available during different periods of the year. The volume and diversity of plants protects the soil from erosion. Also, the decomposition of vegetation helps restore needed minerals to the soil to sustain plant life. Vegetation improves the water cycle by increasing water infiltration into the soil and reducing surface runoff.

An ecologically based habitat management program serves to improve water cycling, mineral cycling, and energy flow and manipulate plant succession. These processes enhance vegetative quantity, quality and diversity. A greater diversity of all life forms, including microorganisms, insects, reptiles, amphibians, birds and mammals may be achieved under sound management. The land's long term health is improved and conserved for future generations to utilize as a source of income, recreation and for aesthetic enjoyment.

Plant communities with a diversity of grasses and native broad-leaved weeds (called forbs) are more productive than those comprised primarily of grasses. The climax plant community of most rangelands is comprised primarily of perennial grasses with a relatively low forb component. While this may be suitable for livestock and some grassland wildlife, most species are dependent on the seeds and foliage of forbs. Periodic disturbances such as fire, soil disturbance, livestock grazing, and mowing can set back plant succession and maintain a diverse plant community, simulating conditions under which plants and animals evolved within ecosystems in Texas.

Below is an example of a plan format that many landowners in the High Plains and Rolling Plains may find applicable to their property, depending on their particular goals and objectives. A fill-in-the-blank plan following this format is attached in Appendix W. This is presented to help landowners develop a Wildlife and Habitat Management Plan. To meet the requirements of the wildlife management tax valuation, a landowner must

annually implement and complete at least one management PRACTICE from at least three of the seven wildlife management ACTIVITIES (i.e. Habitat Control, Erosion Control, Predator Control, Providing Supplemental Supplies of Water, Providing Supplemental Supplies of Food, Providing Shelter, and Making Census Counts to Determine Population). Again, a complete plan will likely include more than three activities, and may include several practices under each activity.

It is important for the landowner to be able to document the wildlife management activities that have taken place during the tax year. Receipts, photographs, and maps are some of the types of documentation a landowner might want to consider using for this purpose. If requested to do so by the county, the landowner may have to file an annual report, including documentation, on management activities undertaken during the year. The required fill-in-the-blank report form is attached in **Appendix W**.

Wildlife and Habitat Management Plan

General Information

Tract Name: _____	County: _____
Owner: _____	Manager: _____
Address: _____	Address: _____
Address: _____	Address: _____
Phone: _____	Phone: _____
Phone: _____	Phone: _____
Individual Preparing the Plan: _____	
Date: _____	

Is property leased for hunting? Yes  No   
 Consultation is with: Owner  Lessee  Manager   
 Location of Property: Distance and direction from nearest town

Is acreage under high fence? Yes  No

**Acreage:**

Cropland:	Non-native Pasture:
Non-Native Grass Pasture:	Native Mixed-Brush Rangeland
Native Grass Rangeland:	Wetlands(optional):
Ponds/Lakes:	Other(specify):

Total Acres:

Current Habitat Description:

Describe vegetation association or type ( i.e. Shortgrass Prairie, Mid-grass Prairie, Mesquite Grassland, Sandsage-Shinnery Oak-Bluestem, CRP, Juniper Breaks, Cottonwood-Soapberry-Hackberry bottomlands, cropland). State dominant plants occurring and/or crops grown on the property. The description can include the soil types and vegetation associated with the various soil types. Describe livestock and wildlife water sources (eg. permanent or seasonal streams, springs, stock tanks, water troughs) that are present. Documentation may include NRCS, TPWD, or other plan, map or aerial photo that may exist for the tract to identify soils, vegetation and water sources. The plant list should include browse plants utilized by big game if big game management is a goal (see appendix). Also, state the degree of use on key browse plants utilized by livestock and big game.

---

---

---

Past History of Land Use and Wildlife:

Describe past land use practices that have been implemented such as prescribed burns, range or pasture reseeding, brush management, etc. Describe past history of cropping, livestock, and wildlife management (census, harvest, etc.). Present other biological information such as the presence of unique cover types, turkey roosts, feral hogs or other exotic big game that compete with native wildlife, et cetera.

---

---

Goals and Objectives:

A discussion and outline of landowner (also family if desired) goals and objectives for the property is necessary to define direction and to realistically assess the set of activities and practices that should be incorporated to integrate wildlife and habitat enhancement.

(Select one or more to guide the wildlife and habitat planning process)

1. Improve habitat for native game species (as designated in the Texas Hunting Guide.)
2. Improve habitat for native nongame species (those species not listed as game species, e.g. songbirds).
3. Manage for habitat and wildlife diversity.
4. Restore, maintain or improve native habitats for wildlife diversity.
5. Generate revenue from native wildlife resources.

6. Improve habitat for rare native species.
7. Protect sensitive habitats or critical species.
8. \_\_\_\_\_
9. \_\_\_\_\_
10. \_\_\_\_\_
11. \_\_\_\_\_
12. \_\_\_\_\_

General Habitat Management Considerations/Recommendations:

Fundamental requirements that must be considered when managing wildlife habitat include food, cover, water and the proper distribution of these elements.

Wildlife and habitat management planning and practices should be directed at maintaining a productive and healthy ecosystem. The ecosystem consists of the plant and animal communities found in an area along with soil, air, water and sunlight. All management activities should be aimed at conserving and improving the quantity and quality of soils, water and vegetation.

Managing for plant diversity is essential. A diverse habitat has a good mixture of various species of grasses, forbs (weeds), and browse (woody) plants. Many of these plants will be at various stages of growth, which adds another element of diversity. The diversity of vegetation increases the availability of food and cover for wildlife species. A greater diversity of range plants results in more food being made available during different periods of the year. The volume and diversity of plants protects the soil from erosion. The decomposition of vegetation also helps restore needed minerals to the soil to sustain plant life. Vegetation improves the water cycle by increasing water infiltration into the soil profile and reducing surface runoff.

An ecologically based habitat management program serves to improve plant succession, water cycling, mineral cycling, and energy flow. These processes enhance vegetative quality, quantity, and diversity. A greater diversity of all life forms, including microorganisms, insects, reptiles, amphibians, birds and mammals may be achieved under sound management. The land's long term health is improved and conserved for future generations to utilize as a source of income, recreation and for aesthetic enjoyment.

Plant communities with a diversity of grasses and weeds are more productive than those comprised primarily of grasses, especially monocultures. The climax plant community of most rangelands is comprised primarily of perennial grasses with a low forb component. While this may be suitable for livestock and some grassland wildlife,

most species are dependent on the seeds and foliage of forbs. Periodic disturbances such as fire, soil disturbance, livestock grazing, and mowing can set back plant succession and maintain a diverse plant community, simulating conditions under which plants and animals evolved within ecosystems in Texas.

<b>Management Practices Normally Beneficial for Representative Wildlife in the High Plains &amp; Rolling Plains Ecoregions</b>	<b>Mule Deer</b>	<b>White-tailed Deer</b>	<b>Pronghorn Antelope</b>	<b>Jack Rabbit</b>	<b>Cottontail Rabbit</b>	<b>Rio Grande Wild Turkey</b>	<b>Bobwhite Quail</b>	<b>Scaled Quail</b>	<b>Lesser Prairie Chicken</b>	<b>Mourning Dove</b>	<b>Waterfowl</b>	<b>Shorebirds</b>	<b>Neotropical Birds</b>	<b>Other Nongame Birds</b>	<b>Cavity-nesting Birds</b>	<b>Swift Fox</b>	<b>Other Furbearers</b>	<b>Bats</b>	<b>Reptiles/Amphibians</b>	<b>Prairie Dogs</b>	<b>Small Mammals</b>	<b>Raptors (Hawks &amp; Owls)</b>
<b>A. HABITAT CONTROL</b>																						
Grazing Management	X	X	X	X	X	X	X	X	X	X	X	X	X	X	X	X	X	X	X	X	X	X
Prescribed Burning	X	X	X	X	X	X	X	X	X	X	X	X	X	X	X	X	X	X	X	X	X	X
Range Enhancement (Reseeding)	X	X	X	X	X	X	X	X	X	X	X	X	X	X	X	X	X	X	X	X	X	X
Brush Management	X	X	X	X	X	X	X	X	X	X	X	X	X	X	X	X	X	X	X	X	X	X
Timber Management		X			X	X	X			X	X		X	X	X		X		X		X	X
Riparian Management / Enhancement	X	X			X	X	X			X	X	X	X	X	X		X	X	X		X	X
Wetland Enhancement	X	X	X	X	X	X				X	X	X	X	X	X		X	X	X		X	X
Habitat Protection-Species of Concern									X			X	X	X		X		X	X	X	X	X
Prescribed Control-Native,Exotic,Feral Species																	X			X		
Wildlife Restoration																				X		
<b>B. EROSION CONTROL</b>																						
Pond Construction	X	X	X			X				X	X	X	X	X	X		X		X		X	
Gully Shaping																						
Streamside, Pond, Wetland Regeneration	X	X	X		X	X				X	X	X	X	X	X		X	X	X		X	X
Herbaceous &/or Woody Plant Establishment	X	X	X	X	X	X	X	X	X	X	X		X	X	X		X	X	X		X	X
Dike / Levee Construction / Management						X				X	X	X	X				X	X	X		X	X
Establish Water Diversion						X					X	X	X				X	X	X		X	X
<b>C. PREDATOR CONTROL</b>																						
Predator Management	X	X	X			X				X						X						
Imported Red Fire Ant Control						X																
Cowbird Control																						
Grackle / Starling / House Sparrow Control																						
<b>D. PROVIDING SUPPLEMENTAL WATER</b>																						
Marsh / Wetland Restoration	X	X	X		X	X				X	X	X	X	X	X		X	X	X		X	X
Spring Development &/or Enhancement	X	X	X			X		X		X	X		X	X	X		X		X		X	X
<b>E. PROVIDING SUPPLEMENTAL FOOD</b>																						
Grazing Management	X	X	X	X	X	X	X	X	X	X	X	X	X	X	X	X	X	X	X	X	X	X
Prescribed Burning	X	X	X	X	X	X	X	X	X	X	X	X	X	X	X	X	X	X	X	X	X	X
Range Enhancement	X	X	X	X	X	X	X	X	X	X	X	X	X	X	X	X	X	X	X	X	X	X
Food Plots	X	X				X	X		X	X												
Feeders & Mineral Supplementation	X	X				X																
Managing Tame Pasture, Old Fields, Croplands	X	X	X	X	X	X	X	X	X	X	X	X	X	X	X	X	X	X	X	X	X	X
Transition Mgt. of Tame Grass Monocultures	X	X	X	X	X	X	X	X	X	X	X	X	X	X	X	X	X	X	X	X	X	X
<b>F. PROVIDING SUPPLEMENTAL SHELTER</b>																						
Nest Boxes, Bat Boxes											X		X	X	X							X
Brush Piles & Slash Retention						X																
Fence Line Management						X	X	X											X		X	X
Hay Meadow, Pasture, & Cropland Management	X	X	X	X	X	X	X	X	X	X	X	X	X	X	X	X	X	X	X	X	X	X
Half Cutting Trees & Shrubs																						
Woody Plant / Shrub Establishment						X	X															
Natural Cavity / Snag Development										X	X		X	X	X		X		X		X	X
<b>G. CENSUS</b>																						
Spotlight Counts	X	X																				
Aerial Counts	X	X	X																			
Track Counts																						

<b>Daylight Deer Herd / Wildlife Composition Counts</b>	X	X	X																	
<b>Harvest Data / Record Keeping</b>	X	X	X			X	X	X	X	X	X									
<b>Browse Utilization Survey</b>	X	X																		
<b>Census &amp; Monitoring of Endangered, Threatened, or Protected Wildlife</b>								X						X		X	X	X	X	X
<b>Census &amp; Monitoring of Nongame Species</b>																				
<b>Miscellaneous Counts</b>						X	X				X		X		X	X	X	X	X	X

# Specific Habitat Management Practices, By Activity

## HABITAT CONTROL

### GRAZING MANAGEMENT

(Refer to Appendix D - Livestock Recommendations, for information to help prepare a specific grazing proposal for the plan.)



Grazing management, which may include deferment, is the planned manipulation of livestock numbers and grazing intensities to increase food, cover, or improve structure in the habitat of selected species.

Grazing management includes: 1) kind and class of livestock grazed, 2) determination and adjustment of stocking rates, 3) implementation of a grazing system that provides planned periodic rest for pastures by

controlling grazing intensity and duration, and/or 4) excluding livestock from sensitive areas to prevent trampling, allow for vegetative recovery, or eliminate competition for food and cover. Planned deferments can be short or long term up to 2 years. Extended rest from grazing (two years or more, if necessary) may be required on some ranges. Seasonal stocker operations may be appropriate to manipulate habitat. Supplemental livestock water (earthen tanks, troughs, wells, piping) to facilitate deferred-rotation grazing of livestock and disperse grazing pressure may be incorporated into planning to improve wildlife habitat. Similarly, it is important to plan and design fence construction to facilitate deferred-rotation grazing of livestock. Fencing can also be used to enhance or protect sensitive areas, woodlands, wetlands, riparian areas and spring sites as designated in plan. Activities should be reviewed annually.

Grazing management systems might include:

- 1 Herd / 3 Pasture (preferably as a step in moving toward a 1 herd / multiple pasture {4+} grazing system)
- 1 Herd / 4 Pasture
- 1 Herd / multiple pasture multiple herd / multiple pasture (goal is to move toward always resting 75% of area)
- High intensity/low frequency (HILF)
- Short duration system

- Other type of grazing system (ex. a short-term stocker system):
- Planned Deferment (e.g., number of years livestock will be deferred from the property, etc.):

## **PRESCRIBED BURNING**

(Refer to Appendix E - Vegetation Management Recommendations, for information to help prepare a specific burning proposal for the plan.)

Prescribed burning is the planned application of fire to enhance habitat and plant diversity, increase food, manipulate cover, or improve structure in the habitat of selected species. Plans should indicate a minimum percent of acreage and general burning cycle (eg. for big game, a minimum of 20% of acreage annually burned over 5 years in the High Plains and Rolling Plains; for upland game birds



**and songbirds, a minimum of 25% of acreage annually burned over 4 years).** Attach a written burning plan as an addendum to the Wildlife and Habitat Management Plan (burn plans and prescribed burning should only be attempted with aid of professionals). The plan should include a map that shows the areas to be burned and the planned dates (month and year) that each area will be burned during the burning cycle. It should also designate areas to be protected from burning, and should incorporate flexibility during periods/ years when conditions are not favorable. Specific areas (i. e. sensitive sites) to be protected from burning should be briefly described and shown on a map.

## **RANGE ENHANCEMENT (Range Reseeding)**

Establish native herbaceous plants (grasses and forbs) that provide food and cover for wildlife or erosion control benefits. Plant species selected and methods for establishment should be applicable to the county. Seeding mixtures providing maximum native plant diversity are recommended. Many herbaceous broadleaf plants (known as forbs, weeds, or wildflowers) are beneficial to wildlife for forage and/or seed production. Key species adapted to the High Plains and Rolling Plains are Eldorado engelmann daisy (warm season forb), Illinois bundleflower (warm season legume), and Maximilian sunflower (warm season forb). See appendix entitled *A Strategy for Management of Wildlife Openings in the Rolling Plains*. Encourage "weed and wildflower" species by selective application of chemical, biological (eg., grazing management) and/or mechanical means on native rangelands, Conservation Reserve



Program lands, and improved grass pastures. Some periodic weed control may be needed in fields converted to native rangeland to assist in the establishment of desirable vegetation. This practice must be a part of an overall habitat management plan and designed to reestablish native habitats within a specified time frame.

**Range Enhancement should annually affect a minimum of 10% of the total area designated in the plan, or a minimum of 10 acres annually, whichever is less, until the project is completed.**



## BRUSH MANAGEMENT

(Refer to Appendix E - Vegetation Management Recommendations, for information to help prepare a specific brush management proposal for the plan.)



Removal of salt cedar through precision aerial application of herbicide can increase plant diversity, enhance habitat for wildlife and help restore instream water flow.

Brush management may be the removal or establishment of woody plants.

It can be the selective removal or suppression of target woody species, including exotics, to allow the increased production of desirable trees, shrubs, grasses, and forbs for forage and nesting or protective cover for selected species. **Brush Management practices should annually affect a minimum of 10% of the total area designated in the plan, or a minimum of 10 acres annually, whichever is smaller.** This practice includes retaining the proper kind, amount, and distribution of

woody cover for selected species. Brush management planning must consider wildlife cover requirements, soil types, slope angle and direction, soil loss and erosion factors, and subsequent planning to control re-invasion. This practice also includes retention of snags to provide cover and nesting sites for cavity nesting animals. When used, herbicides should be applied in strict accordance with label directions.

**This practice can include the planting of native trees and/or shrubs species** to provide food, corridors and/or shelter using species and methods as described by Texas Forest Service at Lubbock or in appendices entitled *Native Brush Establishment on Rangeland for Wildlife* or *Establishing Shelterbelts for Wildlife*.

## RIPARIAN MANAGEMENT AND ENHANCEMENT

Annually and seasonally protect the vegetation and soils in riparian areas (low areas on either side of stream courses) from mismanagement, such as that caused by excessive, long-term livestock trampling. Riparian management and enhancement can include providing livestock with alternate watering sites, deferring livestock grazing in pastures with riparian areas during critical periods of the year, total exclusion of livestock from pastures with riparian areas, and fencing riparian areas to exclude or provide short duration grazing by livestock. Restore important forested habitats including bottomland hardwoods and turkey roost sites. **A minimum of one Riparian Management and Enhancement project must be implemented and maintained every 10 years to qualify.** See appendix entitled *Managing Riparian Habitat for Wildlife in Northwest Texas*.

Proposed riparian management and enhancement projects might include:

- Fencing
  - complete fencing of riparian areas
  - partial fencing of riparian areas
- Deferment from livestock grazing
  - complete deferment
  - partial deferment.
- Establish vegetation
  - trees
  - shrubs
  - herbaceous
  - both sides of stream
  - one side only

### WETLAND ENHANCEMENT

Annually provide seasonal or permanent water for roosting, feeding, or nesting habitat for wetland wildlife. This practice involves shallow wetland management, creation or restoration, greentree reservoir creation or management, playa lake management, and other moist soil management. Playa lake management could include protection from modification, no grazing of playa basin for specified time period, pumping water in winter, moist soil management, seeding grass/legume buffer, and fencing. Grazing management and seeding/fencing buffer could also apply to saline lakes and entrenched draws. Annual management as described in management plan, such as water level manipulation qualifies. **Construction and maintenance of a new project will qualify for 10 years.**



Over 50% of Texas' wetlands have disappeared. Wetland management, restoration or creation is extremely important for wetland dependent wildlife.

## HABITAT PROTECTION FOR SPECIES OF CONCERN

(Refer to Appendix K for information on the management of shortgrass and midgrass prairie habitat for species such as swift fox, black-tailed prairie dogs, burrowing owls, and lesser prairie-chickens which occur in portions of the High Plains and Rolling Plains.



Planned protection and management of land or a portion of land to provide habitat for an endangered, threatened or rare species, such as fencing off critical areas, managing vegetation structure and diversity within species parameters, establishing and maintaining firebreaks to protect critical overstory vegetation, and annually monitoring the species of concern. This practice includes the management/protection of nesting sites, feeding areas, and other critical habitat limiting factors, and the development of additional areas.

The broad-scale management of habitat for migrating/wintering/ breeding neotropical birds (primarily songbirds) should follow guidelines in appendix for zones of importance.

**A minimum of one project must be implemented every 10 years to qualify.**

Proposed projects for habitat protection for species of concerns might include:

- Planned protection/management projects:
- fencing
- firebreaks
- prescribed burning
- habitat manipulation (e.g. thinning, etc.)
- control of nest parasites
- native/exotic ungulate control
- other \_\_\_\_\_

## PRESCRIBED CONTROL OF NATIVE, EXOTIC AND FERAL SPECIES

Use legal means to control the number of grazing and browsing animals. Maintain the population density of native wildlife (particularly white-tailed deer and exotics) at the carrying capacity of the habitat to prevent overuse of desirable plant species and enhance habitat for native wildlife species. Populations of exotics, feral animals, and wildlife should be strictly controlled to minimize negative impact on native wildlife and habitat. **This should incorporate harvest and vegetative monitoring over time to assess control intensity and impact on habitat to meet plan objectives.**



Removal of salt cedar helps increase plant diversity, enhance habitat for wildlife and help restore instream water flow.

Remove or control exotic vegetation impacting native habitats and wildlife populations (eg., large stands of naturalized saltcedar, weeping lovegrass etc.). Convert non-native grass pastures (such as old world bluestem) to native vegetation. **The removal or control of exotic vegetation or the conversion of tame grass pastures must affect a minimum of 10% of the area designated in the plan, or 10 acres**

**annually, whichever is smaller, until the project is completed.**

## WILDLIFE RESTORATION

Restoration or enhancement of habitat to good condition for target species, and reintroduction and population management of TPWD approved native species within the carrying capacity of the habitat as part of an approved restoration area at a scale capable of supporting a sustainable population (eg., Eastern turkey).



## EROSION CONTROL

### POND CONSTRUCTION AND MAJOR REPAIR

Construction or major repair of a permanent water pond for the purpose of preventing, stopping, or controlling erosion, such as being part of an approved NRCS erosion control structure. The project must provide habitat diversity and wildlife benefits. Creation/restoration of shallow water areas as primary production wetlands, and associated water level control and management, should be associated with ponds at every opportunity. **A minimum of one project must be implemented and maintained every 10 years to qualify.**

### GULLY SHAPING

Reducing erosion rates on severely eroded areas by smoothing with top soil to acceptable grades and reestablishing vegetation, primarily native vegetation, with sensitivity to existing wildlife cover and woody vegetation that provides travel corridors. Area must be interseeded with species that provide food and/or cover for wildlife to be applicable (see range enhancement guidelines). This practice may include the feeding of large numbers of cattle on gully sites to contour the eroded areas by way of hoof action to aid in the recovery of the site. **A minimum of one project must be implemented and maintained every 10 years to qualify.**

## **STREAMSIDE, POND, AND WETLAND REVEGETATION**

Revegetating areas along creeks, streams, ponds, and wetlands to reduce erosion and sedimentation, stabilize streambanks, improve plant diversity, and improve wildlife value of sensitive areas. This practice can include: the construction of permanent or temporary fences to exclude, limit, or seasonally graze livestock in order to prevent erosion; the use of native hay to slow and spread water runoff, in areas where vegetation has been recently reestablished (seeds in the hay aid in revegetation); establishing vegetative buffer areas or filter strips along water courses or other runoff areas; establishment of 3:1 upland buffer to playa basin acreage in diverse grass/legume mixture to prevent sedimentation; the installation of rip-rap, dredge spoil, or other barrier material - placement of material along erodible embankments to prevent erosion and protect wildlife habitat; the establishment of stream crossings to provide permanent low water crossings in order to reduce or prevent erosion. This practice must be a part of an overall habitat management plan. **A minimum of one project must be completed and maintained every 5 years, affecting a minimum of 2 acres per project.**



Proposed streamside, pond, and wetland restoration project(s) may include the following techniques:

- native hay bales
- fencing
- filter strips
- seeding upland buffer
- rip-rap, etc.
- stream crossings

## **HERBACEOUS AND/OR WOODY PLANT ESTABLISHMENT ON CRITICAL AREAS (erodible)**

Primarily for erosion control, the establishment of native woody or herbaceous vegetation can also provide food and/or cover for wildlife and restore native habitat. This practice can include: (a) establish and manage wind breaks/shelter-belts by planting multi-row shelter-belts (at least 4 rows in 120' width by 1/4 mile in length), renovate old shelter-belts (re-fence, root-prune, and replace dead trees), and establish shrub mottes, improve plant diversity, and improve wildlife habitat; (b) establish perennial vegetation on terraces and field borders (30 yard minimum width) to reduce erosion, improve plant diversity, and improve wildlife habitat; (c) conservation tillage/no-till farming practices by leaving waste grain and stubble on the soil surface until the next planting season to provide supplemental food or cover for wildlife, control erosion, and improve the soil tilth; (d) manage Conservation Reserve Program cover by maintaining perennial cover established under the Conservation Reservation Program (expired contracts) on erodible sites using proper management techniques such as haying, prescribed grazing or prescribed burning. **A minimum of 150 seedlings must be planted annually on 10 acres or a minimum of 1% of the total designated area must be treated annually.**

## **DIKE/LEVEE CONSTRUCTION/MANAGEMENT**

To establish/maintain wetlands or slow runoff to control or prevent erosion, and to provide habitat for wetland dependent wildlife. Levee management may include reshaping or repairing damage caused by erosion, and re-vegetating levee areas to reduce erosion and sedimentation, and stabilize levees. This practice may include fencing to control and manage grazing use, or installation of water control structures. **A minimum of one project must be completed and maintained every 10 years.**

## **ESTABLISH WATER DIVERSION**

Install water diversion systems that will protect erodible soils and divert water into wetlands to provide habitat for resident and migratory water birds and wetland dependent species. Seed diversion areas to species tolerant of seasonally standing water.

**A minimum of one project must be completed and maintained every 10 years.**



A flashboard riser box attaches to a pipe installed in a levee to create a shallow water wetland for wildlife.

## **PREDATOR CONTROL**

### **PREDATOR MANAGEMENT**

The management of predator populations to increase survival of target species. Key native predator species may include coyote, raccoon, bobcat, mountain lion, and rat snakes, while exotic predators may include feral house cat, feral dog, and feral hogs (see imported red fire ants in separate paragraph). Predator Control alone will not be an applicable practice unless it is part of an overall plan to manage the habitats and populations of the target species. Texas Parks and Wildlife Department advocates elimination of feral/exotic predators, with the thoughtful management of native predators as an integral part of functioning natural systems. **The predator control plan should be prepared or approved by a competent professional and include the list, duration and intensity of methods to remove the target species annually.**

### **CONTROL OF COWBIRDS**



Reducing populations of these birds for the purpose of decreasing nest parasitism of target neotropical bird species (eg. endangered Black-capped Vireos and other songbirds) in a PLANNED PROGRAM (see Appendix S, T, and W). **Removal of at least 30 cowbirds annually is required to qualify.**

### **GRACKLE/STARLING/HOUSE SPARROWS CONTROL**

Reducing populations of grackles and/or starlings and/or house sparrows for the purpose of controlling avian diseases and reducing overcrowding to exclusion of other avian fauna in a planned program (see Appendix J) particularly targeting white-winged dove and other neotropical birds. **Removal of at least 30 grackles/starlings/house sparrows annually is required to qualify.**

Proposed Grackle/Starling/House Sparrow Control Project(s) may include:

- trapping
- shooting
- scare tactics

## **PROVIDING SUPPLEMENTAL WATER**

\* This category includes providing supplemental sources of water specifically for wildlife in habitats where water is limited. Wildlife water developments are in addition to those sources already available to livestock and may require protection from livestock.

## MARSH/ WETLAND RESTORATION OR DEVELOPMENT

Providing supplemental water in the form of shallow wetlands for wetland dependent wildlife. Applicable even in areas where water is not a critical limiting factor for upland species of wildlife.

May include seasonally available water such as greentree reservoirs, specific shallow roost pond development, seasonally flooded crops and other areas, moist soil management, and winter pumping into playa basins less than 10 acres in size (half of the eligible basins on a property).

Based on wildlife needs and suitability of the property, the annual manipulation with control structures is desirable. **The minimum requirement to qualify under this practice is one marsh/wetland restoration or development project every 5 years; or the annual water management of project existing wetland (playa).** Call for TPWD OR NRCS for professional assistance when creating/enhancing wetlands.



## WELL/TROUGHS/WINDMILL OVERFLOW/OTHER WILDLIFE WATERING FACILITIES

Designing and implementing water systems that provide supplemental water for wildlife and provide habitat for wetland plants. This practice may include modifying existing water systems to make water more accessible to wildlife (eg. fenced windmill overflows available to wildlife on the ground).



It may also include drilling wells if necessary and/or constructing pipelines to distribute water and/or diverting water with specialized wildlife watering facilities. **A minimum of one project per 5 years must be completed to qualify; or consistent water management for wildlife at sites.**

Proposed Well/Troughs/Windmill Overflow/Other Wildlife Watering Facility Project(s) may include: (see Appendix O):

- Drill new well:
  - windmill
  - pump
  - pipeline
- Modification(s) of existing water source:
  - fencing



- overflow
- trough modification
- pipeline
- Distance between water sources {waters} \_\_\_\_\_
- Type of Wildlife Watering Facility
  - PVC/Quickline/Other Pipe Facility
  - Drum with Faucet or Float
  - Small Game Guzzler
  - Windmill Supply Pipe Dripper
  - Plastic Container
  - In-ground Bowl Trough
  - Big Game Guzzler
  - Inverted Umbrella Guzzler
  - Flying Saucer Guzzler
  - Ranch Specialties Wildlife Guzzler
  - Other \_\_\_\_\_

Capacity of Water Facility(ies): \_\_\_\_\_

## **SPRING DEVELOPMENT AND/OR ENHANCEMENT**

Implementing methods designed to protect the immediate area surrounding a spring. This practice may include excluding and/or controlling livestock around springs to maintain native plant and animal diversity and/or moving water through a pipe to a low trough or shallow wildlife water overflow, making water available to livestock and wildlife while preventing degradation of the spring area from trampling and other animal impacts. It may also include restoring a degraded spring by the judicious removal of dense brush (possibly over a period of years) and the revegetation of drainages and canyons with herbaceous plants, and maintaining the restored spring as a source of wildlife water. Important considerations when planning and implementing brush removal are preventing soil loss and erosion and maintaining critical habitat, as well as nesting and roosting areas for wildlife. **A minimum of one project per 5 years must be completed to qualify, or the consistent management and maintenance of existing or restored springs to prevent degradation.**

Proposed Spring Development and/or Enhancement Project(s) may include the following:

- Fencing
- Water diversion/pipeline
- Brush removal
- Spring clean out
- Ponds, stock tanks, water impoundments (see stock ponds, tanks, lakes)

## **PROVIDING SUPPLEMENTAL FOOD**

### **GRAZING MANAGEMENT**

(This is identical to Grazing Management in Activity A. Refer to Grazing Management in Activity A for information to prepare a specific grazing proposal for the plan under this Activity).

### **PRESCRIBED BURNING**

(This is identical to Burning Prescribed in Activity A. Refer to Prescribed Burning in Activity A for information to prepare a specific burning proposal for the plan under this Activity)

### **RANGE ENHANCEMENT (Range Re-Seeding)**

(This is identical to Range Enhancement (Reseeding) in Activity A. Refer to Range Enhancement (Range Reseeding) in Activity A for information to prepare a specific range enhancement proposal for the plan under this Activity)

### **FOOD PLOTS**

The establishment of locally adapted annual (spring and fall) or perennial forages on suitable soils to provide supplemental foods and cover during critical periods of the year. Livestock should be generally excluded from small food plots. **The shape, size, location, and percentage of total land area should be based on requirements for the target species (i. e. 5% of area for white-tailed deer, 30% of the farm for ring-necked pheasants) and should meet goals of a comprehensive wildlife plan.**

Managing the habitat for proper nutrition should be the primary management goal. Supplemental feeding and /or planting of food plots are not a substitute for good management. These practices should only be considered as "supplements" to the native habitat, not as "cure-alls" for low quality and/or poorly managed habitats. Supplemental feeding should always be combined with population management, or the resulting artificially higher numbers of animals will have a negative impact on native plants. Consult with the NRCS, TCE, TPWD, and local seed dealers for food plot mixtures suitable for your area, as well as local soil conditions. Plant according to dealer recommendations with proper equipment.

Proposed Food Plots Project(s) may include the following considerations:

- Size(s) \_\_\_\_\_
- Fencing required?

- yes
- no
- Plantings:
  - cool season annual crops, i.e. wheat, rye, clovers, etc.
  - warm season annual crops, i.e. sorghums, millets, cowpeas, etc.
  - annual mix of native plants
  - perennial mix of native plants
- Irrigation required?
  - yes
  - no
- Fertilizer recommended?
  - Yes
  - no

## FEEDERS AND MINERAL SUPPLEMENTATION



Dispensing supplemental foods from artificial devices to meet the nutritional requirements of selected wildlife species during critical periods of the year. This practice must be a part of a comprehensive habitat management plan that addresses all animal units and attempts to maintain populations below carrying capacity. Using feeders to attract big game animals for harvest does not apply unless used for **selective harvest** to control excessive numbers of deer and/or exotic ungulates as defined within a

comprehensive wildlife management plan. The plan should include a targeted harvest quota that is regularly measured and achieved or nearly so. Aflatoxin levels in grain feeds should not exceed 20 ppb. Mineral supplementation may be supplied from artificial devices or by other means (poured on ground, blocks, etc.). This practice should be a part of an overall habitat management plan that addresses all animal units and attempts to approach carrying capacity. **A minimum of one free-choice feeder per 160 acres required to qualify.**

Proposed Feeders and Mineral Supplementation Project(s) should include the following considerations:

- Purpose:
  - supplementation
  - harvesting of wildlife
- Targeted wildlife species
- Feed type
- Mineral type

- Feeder type
  - Number of feeders
- Method of mineral dispensing
  - Number of mineral locations
- Year round
  - Yes
  - No, if not, when practiced \_\_\_\_\_

## MANAGING IMPROVED PASTURES, OLD FIELDS AND CROPLANDS



Purple clover overseeded into a pasture will provide supplemental forage for deer, turkey, and cattle.

This practice may include: over-seeding or planting cool season and/or warm season legumes and/or small grains in pastures, easements (pipelines), or range land in order to provide a supplemental food for wildlife, using plant materials and establishment methods applicable to the county; periodic ground disturbance through shallow discing that encourages habitat diversity, the production of native grasses and forbs for supplemental foods, increasing bare ground feeding habitat for

selected species. Conservation tillage practices are recommended that leave

waste grain and stubble on the soil surface until the next planting season to provide supplemental food or cover for wildlife, control erosion, and improve soil tilth. Shred, disk, and/or fertilize native vegetation to improve the growth and quality of plants. Many broadleaf plants (forbs - weeds and wildflowers) are beneficial to wildlife for forage and/or seed production. Encourage "weed and wildflower" species by selective application of chemical, biological (eg., grazing management) and/or mechanical means on native range lands and non-native grass pastures. **A minimum of 5 percent of the designated area must be treated annually to qualify.**

## TRANSITION OF IMPROVED GRASS MONOCULTURES

Annually overseed improved grass pastures with locally adapted legumes (eg. clovers, vetches, peas) to increase the plant diversity, provide supplemental wildlife foods, and gradually convert the tame pastures to native vegetation as per wildlife and habitat plan. Legumes should be planted annually until all pastures are established to native vegetation. See Texas Tech Management Note No. 15 as applicable to CRP lands. **A minimum of 25 percent of the designated area must be treated annually to qualify.**

## **PROVIDING SUPPLEMENTAL SHELTER**

The best shelter and cover for wildlife is provided by a well managed habitat. Some practices can be implemented to provide types of shelter that may be limited in the habitat.

### **NEST BOXES, BAT BOXES**

The installation of artificial boxes or cavities to provide nesting or denning habitat for selected species. **Number and location of nest boxes should be consistent with habitat needs and territorial requirements of the target species, and sufficient over the area to provide a real supplement to the target population and address an identified severe limiting factor as part of a comprehensive wildlife management plan.** In the Rolling Plains, wood duck nest boxes should be erected at the rate of **1 per 200 yards in cottonwood bottoms where surface water is available.**



Proposed Nest Boxes, Bat Boxes Project(s) may include:

- Target species?
- Box type:
  - cavity type.
  - bat boxes.
  - raptor poles.

### **BRUSH PILES AND SLASH RETENTION**

The planned construction, maintenance, and/or retention of brush piles to provide additional wildlife cover in habitats where low-growth, woody cover has been identified as a limiting factor for the selected species. This practice includes leaving dead brush on the ground where it was cut or uprooted to provide wildlife cover and protection for seedlings of desirable plant species. Stacking posts or limbs in a “teepee” arrangement can provide adequate cover for small game and other wildlife in open areas; however, artificial cover of this type must be suspended on a frame above the ground if it is to subsist and be of any long term value (eg. 30’ diameter brush pile at 1 per 40 acres in CRP lands to meet optimum overhead protective cover requirement for bobwhite quail).

This practice must be part of a comprehensive wildlife management plan. **A minimum of 3 percent of the designated area must be treated annually to qualify.**

### **FENCE LINE MANAGEMENT**

Maintain, establish, or allow the establishment of trees, shrubs, forbs, and grasses on fence lines to provide wildlife food and cover, **minimum of 30 yards wide.** This practice is most beneficial where cover is limiting in the habitat, i.e. cropland or tame pasture, and should be part of a comprehensive wildlife management plan. **A minimum length of 100 yards of Fence Line Management is required annually to qualify.**

## HAY MEADOW, PASTURE AND CROPLAND MANAGEMENT FOR WILDLIFE



**Mowing/swathing of hay fields should be postponed until after the peak of nesting/rearing period of ground-nesting birds and mammals.**

**Mow/shred 1/3 of open areas per year, preferably in strips or mosaic types of patterns, to create "edge" and structural diversity. Weeds are an important source of food for many wildlife species, therefore minimize weed control practices. Use no**

till/minimum till agricultural practices to leave waste grain and stubble on the soil surface until the next planting season to provide supplemental food or cover for wildlife, control erosion, and improve soil tilth. Other forms of supplementing and providing shelter include roadside right-of-way management for ground-nesting birds, establishing perennial vegetation on circle irrigation corners, terraces, fencerows and field borders, establishing multi-row shelterbelts or renovating old shelterbelts, and protecting and managing old homesites, farmsteads and Conservation Reserve Program cover. See Texas Tech Management Note No. 15 as applicable to CRP lands.

Cropland Management Project(s) should consider:

- Acreage to be treated
- Shelter establishment:
  - irrigation corners
  - road side management
  - terrace/wind breaks
  - field borders
  - shelterbelts
- Conservation Reserve Program lands management
- Type of vegetation for establishment:
  - annual
  - perennial
- List species and percent of mixture
- Deferred mowing
  - Period of deferment
- Mowing
  - Acres mowed annually

- No till/minimum till

### HALF-CUTTING TREES OR SHRUBS

The practice of partially cutting branches of a live tree or shrub to encourage horizontal cover near the ground, providing supplemental cover in habitats where cover is lacking (see TPWD Bulletin 48) relative to an overall plan for target wildlife species. **A minimum of 25 trees/shrubs in one ¼ acre block must be half-cut annually to qualify.**



In open areas with very little near-ground cover, cutting half-way through the lower mesquite limbs and breaking them to the ground can form a "cage" that provides escape and roost cover for wildlife.

### WOODY PLANT/SHRUB ESTABLISHMENT

Planting and protecting native seedlings to establish wind rows and shrub thickets, or to restore wooded habitats within former croplands, tame pastures or CRP land. In agricultural areas, this practice may include **planting a minimum of 150 seedlings annually, or 4 rows in a 120 foot width by a 1/4 mile in length.** Plantings should consist of native trees and shrubs that produce hard or soft mast, or provide nesting or escape cover. Plantings should be made in groups to provide both cover and additional food, rather than scattered individual trees.

See Brush Management in Activity A for information on other practices that may qualify under this activity. This practice can not qualify under more than one Activity.

### NATURAL CAVITY/SNAG DEVELOPMENT

Create and/or retain "snags" (dead trees) for cavity-dwelling species. Undesirable trees can be girdled or individually treated with herbicide and left standing. Special measures must be implemented to protect the snags during prescribed burning, mechanical brush management, etc. **A minimum of 5 snags per acre on 5% of the acreage must be created/retained annually to qualify.**



Girdling trees is an effective means of creating snags, but be selective by avoiding mast producing trees (oaks, hickories) and judicious in extent.

## CENSUS

This activity provides an estimate of species numbers, population trends, population density, age structure, or sex ratio using accepted survey techniques. Results of annual surveys should be recorded on appropriate forms as evidence of completion of this practice. Selection of specific survey techniques should be appropriate to the species of interest and at a level of intensity to achieve proper management of the resource in connection with a comprehensive wildlife management plan.

**Note:** For census activity to qualify for deer, a combination of methods must be used to obtain a reasonable assessment of the deer herd for habitat and harvest management. For most properties, this will require spotlight surveys, daylight or incidental observations, and harvest data for all deer (age, weight, and antler measurements). Similar intensity should be applied for other species to qualify in this activity.

### SPOTLIGHT COUNTS

Counting animals at night along a predetermined route using a spotlight. Spotlight counts should follow accepted methodology. **A minimum of three counts must be completed annually.**



### AERIAL COUNTS

Use of a fixed-wing aircraft or helicopter to count animals. **Counts should employ accepted methodology for the region and be performed by a trained individual annually.**

### DAYLIGHT DEER HERD/WILDLIFE COMPOSITION COUNTS/PHOTO STATIONS

Driving counts used to census deer in daylight hours to enhance information of sex/age structure (buck/doe/fawn), as well as determine annual trends in populations through dove, quail, and turkey sightings. **Counts should be conducted on standardized transects along 5 mile minimum lines and run at least 3 times.**



## HARVEST DATA COLLECTION/RECORD KEEPING

Collect all age, weight, and antler development data from harvested deer. Age and sex information should be obtained from game birds and waterfowl to determine sex ratios and annual production.

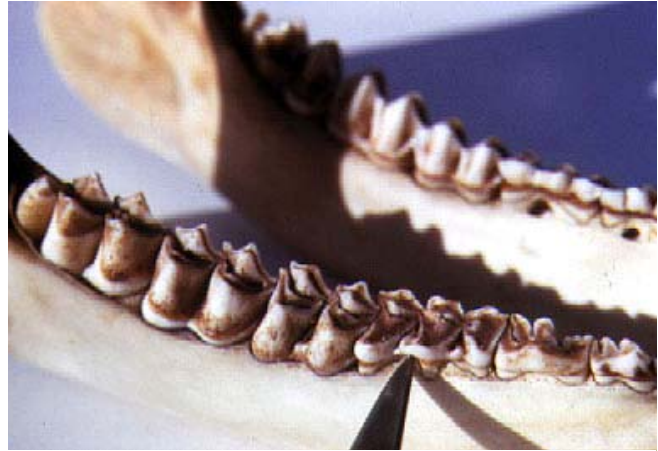

Keeping good harvest records is essential to understanding effects on target populations. Lower jaw bones are used to age deer, and deer aging publications may be obtained from Texas Parks and Wildlife or your County Extension Agent.

### BROWSE UTILIZATION SURVEYS

Annually (normally during the winter) examine deer browse species for degree of utilization on each major vegetative site on the property through vegetation analysis and stem counts.

### CENSUS OF ENDANGERED, THREATENED, OR PROTECTED WILDLIFE

Regular, periodic counts of the target species used to enhance management or increase knowledge of local, regional, or state status.

### CENSUS AND MONITORING OF NONGAME WILDLIFE SPECIES

Regular, periodic counts of nongame wildlife species used to enhance management or increase knowledge of local, regional, or state status. This practice would also include developing checklists of wildlife diversity for the property, and should be a part of a comprehensive wildlife management plan.



### MISCELLANEOUS COUNTS:

Specific species may require special survey techniques. These may include the following and should be addressed in the management plan:



- Time/area counts
  - Roost counts
  - Song bird transects and counts
  - Quail call and covey counts
  - Point counts
  - Drift fences and pitfall traps
  - Small mammal traps
  - Bat census (ex. Departures)
  - Other. Describe:
-

## Appendix B

### **Wildlife Tax Valuation Rules**

**Refer to the Texas Administrative Code link below for the complete text of all rules as adopted in December 2008:**

[http://info.sos.state.tx.us/pls/pub/readtac\\$ext.ViewTAC?tac\\_view=5&ti=34&pt=1&ch=9&sch=G&rl=Y](http://info.sos.state.tx.us/pls/pub/readtac$ext.ViewTAC?tac_view=5&ti=34&pt=1&ch=9&sch=G&rl=Y)

The following is a summary of changes made by the new rules that were adopted on December 11, 2008. Our purpose is to give an overview of rule changes for use by landowners and those that assist them. If you have questions, please contact Linda Campbell (512-389-4395) or Todd George (512-389-4329), Texas Parks and Wildlife Department, Austin.

#### ***1. New definitions have been added and some existing definitions have been clarified***

- Wildlife Management Practices are defined as those listed in the Tax Code (23.51(7)(A) - Habitat Control, Erosion Control, Predator Control, Providing supplemental supplies of water, Providing supplemental supplies of food, providing shelters, Making census counts to determine population.
- Wildlife Management Activities are defined as methods of implementing wildlife management practices as described in the TPWD guidelines for each region.
- The definition of a tract of land was changed to clarify that tracts of land will be considered contiguous even though they are bisected by a public road or body of water.
- The definition of Wildlife Management Property Association was changed to clarify that tracts of land of landowners in the association will be considered contiguous even though they are bisected by a public road or body of water. Other requirements are the same.
- The term sustained breeding population was changed to breeding population to be consistent with the Tax Code and because the term sustained refers to breeding, migrating, and wintering populations of wildlife. The definition is the same.
- The term Wildlife Use Percentage has been changed to Wildlife Use Requirement in recognition that the formula that determines the minimum acreage requirements is not actually a percentage of use.

#### ***2. Changes to the Wildlife Use Appraisal Regions***

The appraisal regions have been reorganized to more closely track the defined ecological regions as specified in the TPWD Wildlife Management Guidelines. If a county is in more than one ecological region, the region that comprises the majority of the county was selected.

**Trans Pecos**

- Brewster
- Crane
- Culberson
- El Paso
- Hudspeth
- Jeff Davis
- Loving
- Pecos
- Presidio
- Reeves
- Terrell
- Ward
- Winkler

**High Plains**

- Andrews
- Armstrong
- Bailey
- Carson
- Castro
- Cochran
- Crosby
- Dallam
- Dawson
- Deaf Smith
- Ector
- Floyd
- Gaines
- Glasscock
- Hale
- Hansford
- Hartley
- Hockley
- Howard
- Hutchinson
- Lamb
- Lubbock
- Lynn
- Martin
- Midland
- Moore
- Ochiltree
- Oldham
- Parmer
- Potter
- Randall
- Sherman
- Swisher
- Terry
- Upton

- Yoakum

**Rolling Plains**

- Archer
- Baylor
- Borden
- Briscoe
- Callahan
- Childress
- Clay
- Coke
- Coleman
- Collingsworth
- Concho
- Cottle
- Dickens
- Donley
- Fisher
- Foard
- Garza
- Gray
- Hall
- Hardeman
- Haskell
- Hemphill
- Jones
- Kent
- King
- Knox
- Lipscomb
- McCulloch
- Mitchell
- Motley
- Nolan
- Roberts
- Runnels
- Scurry
- Shackelford
- Stonewall
- Taylor
- Throckmorton
- Tom Green
- Wheeler
- Wichita
- Wilbarger

**Western Edwards Plateau**

- Crockett
- Edwards

- Irion
- Kimble
- Menard
- Reagan
- Real
- Schleicher
- Sterling
- Sutton
- Val Verde

**Eastern Edwards Plateau**

- Bandera
- Bexar
- Blanco
- Burnet
- Comal
- Gillespie
- Hays
- Kendall
- Kerr
- Llano
- Mason
- San Saba
- Travis
- Williamson

**Cross Timbers and Prairies**

- Bell
- Bosque
- Brown
- Comanche
- Cooke
- Coryell
- Denton
- Eastland
- Erath
- Hamilton
- Hood
- Jack
- Johnson
- Lampasas
- Mills
- Montague
- Palo Pinto
- Parker
- Somervell
- Stephens
- Tarrant

- Wise
- Young

***South Texas Plains***

- Atascosa
- Dimmit
- Duval
- Frio
- Jim Hogg
- Kinney
- LaSalle
- Live Oak
- Maverick
- McMullen
- Medina
- Starr
- Uvalde
- Webb
- Zapata
- Zavala

***Blackland Prairie***

- Collin
- Dallas
- Delta
- Ellis
- Falls
- Fannin
- Grayson
- Hill
- Hunt
- Kaufman
- Lamar
- Limestone
- McLennan
- Milam
- Navarro
- Rockwall

***Post Oak Savannah***

- Bastrop
- Bee
- Brazos
- Burleson
- Caldwell
- DeWitt
- Fayette
- Franklin
- Freestone
- Goliad

- Gonzales
- Grimes
- Guadalupe
- Henderson
- Hopkins
- Karnes
- Lavaca
- Lee
- Leon
- Madison
- Rains
- Red River
- Robertson
- Titus
- Van Zandt
- Washington
- Wilson

***Pineywoods***

- Anderson
- Angelina
- Bowie
- Camp
- Cass
- Cherokee
- Gregg
- Hardin
- Harrison
- Houston
- Jasper
- Liberty
- Marion
- Montgomery
- Morris
- Nacogdoches
- Newton
- Panola
- Polk
- Rusk
- Sabine
- San Augustine
- San Jacinto
- Shelby
- Smith
- Trinity
- Tyler
- Upshur
- Walker
- Wood

***Upper Gulf Prairies and Marshes***

- Austin
- Brazoria
- Calhoun
- Chambers
- Colorado
- Fort Bend
- Galveston
- Harris
- Jackson
- Jefferson
- Matagorda
- Orange
- Victoria
- Waller
- Wharton

***Lower Gulf Prairies and Marshes***

- Aransas
- Brooks
- Cameron
- Hidalgo
- Jim Wells
- Kenedy
- Kleberg
- Nueces
- Refugio
- San Patricio
- Willacy

# Wildlife Use Appraisal Regions

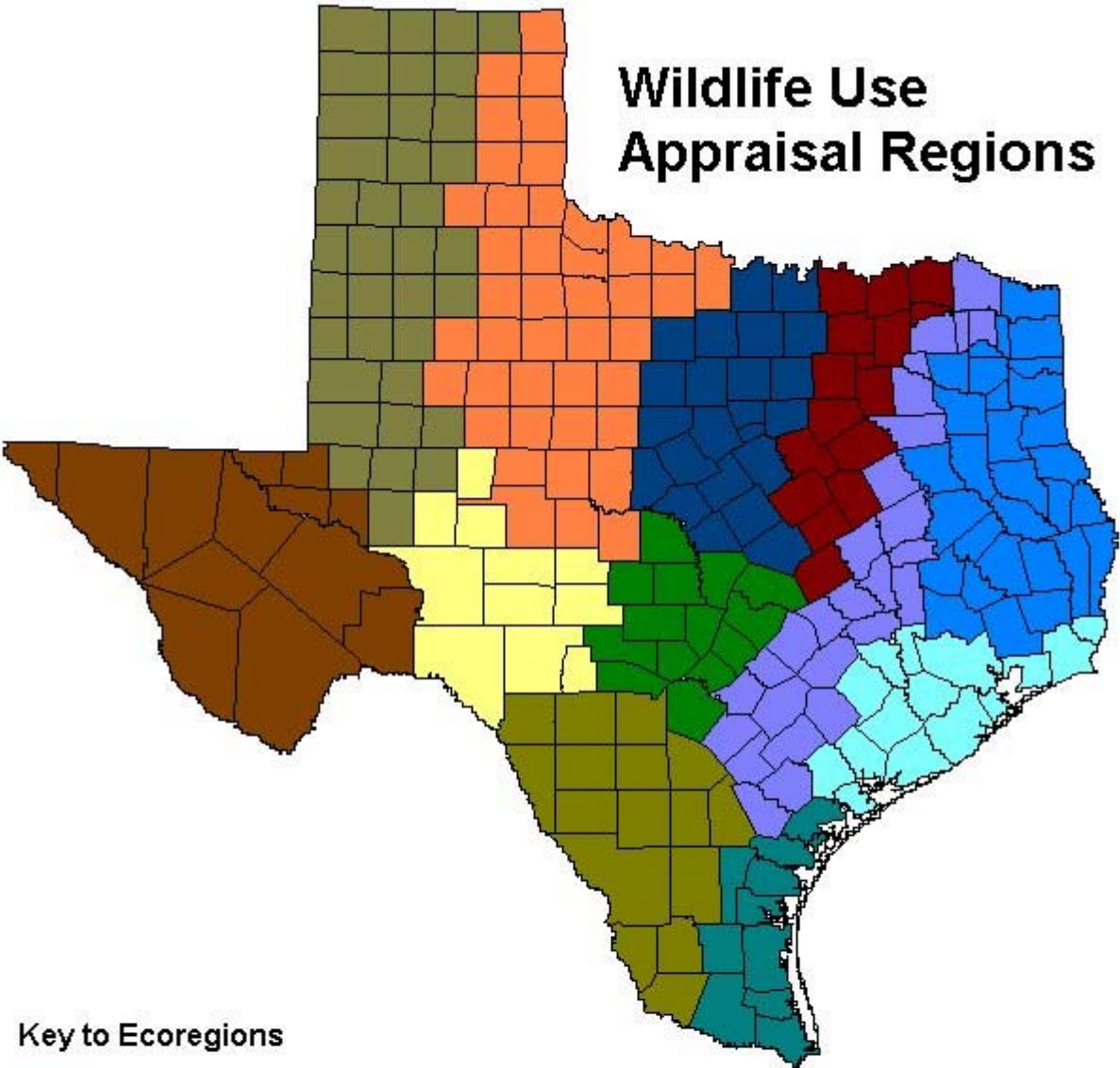

## Key to Ecoregions

- |  |   |
|--|---|
|  Trans Pecos              |  South Texas Plains            |
|  High Plains              |  Blackland Prairie             |
|  Rolling Plains           |  Post Oak Savannah             |
|  Western Edwards Plateau  |  Pinewoods                     |
|  Eastern Edwards Plateau  |  Upper Gulf Prairies & Marshes |
|  Cross Timbers & Prairies |  Lower Gulf Prairies & Marshes |

**3. Changes to the Wildlife Management Plan (WMP) requirements are as follows:**

- The Chief Appraiser may accept, but may not require, a WMP not completed on a TPWD form. All required information must be provided.
- An appraisal district may require an annual report.
- A Wildlife Management Property Association may file a single WMP or annual report, but all members must sign the WMP or annual report.
- Practices implemented in WMPs must not harm endangered species, but they are not required to benefit these species – the change mirrors requirements of the Endangered Species Act.

**4. Changes to the Qualifications for Wildlife Management Use are as follows:**

- The TPWD Comprehensive Wildlife Management Guidelines set the degree of intensity standard for wildlife management practices and activities implemented in the various ecological regions.
- The landowner selects which 3 of 7 wildlife management practices to implement each year.
- Property must now be "actively managed" to sustain a breeding, migrating, or wintering population of indigenous wildlife, where prior rule required that the land was "instrumental in supporting" this wildlife.
- Primary Use is the same as Principal Use and is defined as:
  - The property is actively managed according to a WMP.
  - Wildlife management practices and activities are given priority over other uses.
  - Secondary uses of the land do not significantly and demonstrably interfere with wildlife management practices and activities and are not detrimental to the wildlife being managed.

**5. Changes to Wildlife Use Requirement are as follows:**

- Use or minimum acreage requirements now apply only when the property has had a reduction in acreage – it no longer requires both a change in ownership and a reduction in acreage.
- The Chief Appraiser in each county, with the advice and consent of the Appraisal District Board of Directors, now selects the wildlife use requirement from the allowable range based on the appropriate appraisal region.
- Minimum acreage ranges are the same except for Terrell (increase), Clay (increase), McCulloch (increase) and Bee (decrease) counties. Changes result from the reorganization of appraisal regions.
- Existing properties in wildlife management are grandfathered and not affected by these changes.

## \_Appendix C

### Wildlife Management Plan Overview

*Use this list to assist in planning your wildlife management activities*

TREATMENTS	Practice	Year 1	Year 2	Year 3	Year 4	Year 5
<b>Habitat Control:</b>						
HC: Wildlife & Habitat Management Plan						
HC: Grazing Management						
HC: Prescribed Burning						
HC: Range Enhancement (re-seeding)						
HC: Brush Management						
HC: Vegetation Surveys						
HC: Fence Modification						
HC: Riparian Management and Enhancement						
HC: Wetland Enhancement						
HC: Habitat Protection/Species of Concern						
HC: Prescribed Control of Species						
HC: Wildlife Restoration						
<b>Erosion Control:</b>						
EC: Pond Construction						
EC: Gully Shaping						
EC: Streamside, Pond, Wetland Revegetation						
EC: Native Plant Establishment on Erodible Areas						
EC: Dike/Levee Construction/Management						
EC: Establish Water Diversion						
<b>Predator Control:</b>						
PC: Predator Management						
PC: Control of Brown-headed Cowbirds						
PC: Grackle/Starling Control						
<b>Supplemental Water:</b>						
SW: Marsh/Wetland Restoration or Development						
SW: Well/Trough/Windmill Overflow						
SW: Spring Development and/or Enhancement						
<b>Supplemental Food:</b>						
SF: Grazing Management						
SF: Prescribed Burning						
SF: Range Enhancement (Re-seeding)						
SF: Fence Modification						
SF: Food Plots						
SF: Feeders and Mineral Supplementation						
SF: Managing Tame Pasture, Old Fields, Croplands						
<b>Providing Shelters:</b>						
PS: Nest Boxes, Bat Boxes						
PS: Brush Piles and Slash Retention						
PS: Fence Line Management						
PS: Cropland Management						
PS: Half-Cutting Trees or Shrubs						
PS: Woody Plant/Shrub Establishment						
PS: Natural Cavity/Snag Development						
<b>Census:</b>						
C: Spotlight Counts						
C: Aerial Counts						
C: Daylight Wildlife Counts						
C: Harvest Data Collection & Record Keeping						
C: Browse Utilization Surveys						
C: Endangered, Threatened or Protected Species						
C: Nongame Wildlife Species						
C: Time/area Counts						
C: Roost Counts						
C: Song Bird Transects and Counts						
C: Quail Call and Covey Counts						
C: Point Counts						

SEVEN GENERAL CRITERIA FOR WILDLIFE MANAGEMENT VALUATION ON OPEN SPACE LAND IN THE **HIGH PLAINS ECOLOGICAL AREA** AND SPECIFIC PRACTICES FOR EACH

(Total of 40 practices in **bold print**)

Habitat Control

**Playa lakes, protect from modification**  
**Playa lakes, protect vegetation**  
**Playa lakes, maintain water by pumping**  
**Playa lakes, moist soil management**  
**Playa lakes, seed grass/legume buffer**  
**Playa lakes buffer, prescribed graze/burn**  
**Playa lakes, fence to > manageability**  
**Saline lakes, protect from modification**  
**Saline lakes, seed grass/legume buffer**  
**Saline lakes buffer, prescribed graze/burn**  
**Saline lakes, fence to > manageability**  
**Seed waterways and critical areas (erodible)**  
**Roadside management for ground-nesting birds**  
**Prescribed grazing systems for wildlife**  
**Prescribed burning systems for wildlife**  
**Reseed shortgrass prairie with native mixes**  
**Annual discing (forbs, brood range)**  
**Pipelines and water storage tanks**  
**Brush management for wildlife**  
**Establish perennial vegetation on circle irrigation corners**  
**Fencerow/field border cover management**  
**Establish perennial vegetation on terraces**  
**Conservation tillage/no-till farming practices**  
**Manage prairie dog towns with technical assistance**  
**Retain/enhance Conservation Reserve Program cover**

Erosion Control

Playa lakes, protect vegetation  
Playa lakes, seed grass/legume buffer  
Playa lakes buffer, prescribed graze/burn  
Playa lakes, fence to > manageability  
Saline lakes, fence to > manageability  
Seed waterways and critical areas (erodible)  
Roadside management for ground-nesting birds  
Prescribed grazing systems for wildlife  
Prescribed burning systems for wildlife  
Reseed shortgrass prairie with native mixes



Brush management for wildlife  
**Woody cover, establish multi-row shelterbelts**  
**Woody cover, renovate old shelterbelts**  
**Woody cover, establish shrub mottes**  
Establish perennial vegetation on circle irrigation corners  
Fencerows/field borders seeded to perennial cover  
Establish perennial vegetation on terraces  
Conservation tillage/no-till farming practices  
Retain Conservation Reserve Program cover

Predator Control/(Management)

**Predator management (coyotes, feral hogs)**

Providing Supplemental Water

Playa lakes, seed grass/legume buffer  
Playa lakes, maintain water by pumping  
Playa lakes, moist soil management  
**Provide windmill overflow water**  
**Develop ponds/shallow water areas for wildlife**  
Pipelines and water storage tanks

Providing Supplemental Food

Playa lakes, protect vegetation  
Playa lakes, seed grass legume buffer  
Playa lakes, moist soil management  
Playa lakes, fence to > manageability  
Prescribed grazing systems for wildlife  
Prescribed burning systems for wildlife  
Annual discing to promote forbs  
**Annual food plots (cereal grains)**  
**Perennial food plots**  
Brush management for wildlife  
Woody cover, establish shrub mottes  
**Protect old homesites, farmsteads**  
Establish perennial vegetation on circle irrigation corners  
Fencerows/field borders seeded to perennial cover  
Conservation tillage/no-till farming practices

Providing Supplemental Shelter

Playa lakes, protect vegetation  
Playa lakes, seed grass/legume buffer  
Playa lakes, moist soil management

Playa lakes buffer, prescribed graze/burn  
Playa lakes, fence to > manageability  
Seed waterways and critical areas (erodible)  
Roadside management for ground-nesting birds  
Prescribed grazing systems for wildlife  
Prescribed burning systems for wildlife

**Improving mesquite cover by half-cutting**

Brush management for wildlife

**Create artificial shelters**

Woody cover, establish multi-row shelterbelts

Woody cover, renovate old shelterbelts

Woody cover, establish shrub mottes

Protect old homesites, farmsteads

Establish perennial vegetation on circle irrigation corners

Fencerows/field borders seeded to perennial cover

Establish perennial vegetation on terraces

**Construct/erect artificial nest structures**

Retain Conservation Reserve Program cover

Census (Population/Surveys)

**Big game annual population surveys**

**Big game harvest management (restrictive)**

**Big game harvest record-keeping system**

**Note:** All practices could be implemented on existing or new CRP contracts, so long as there is no conflict/violation of USDA regulations.

SEVEN GENERAL CRITERIA FOR WILDLIFE MANAGEMENT VALUATION ON OPEN SPACE LAND IN THE **ROLLING PLAINS ECOLOGICAL AREA** AND SPECIFIC PRACTICES FOR EACH

(Total of 33 practices in **bold print**)

Habitat Control

**Seed waterways and critical areas (erodible)**  
**Roadside management for ground-nesting birds**  
**Prescribed grazing systems for wildlife**  
**Riparian management for wildlife**  
**Prescribed burning systems for wildlife**  
**Reseed mixed-grass prairie with native mixes**  
**Annual discing (forbs, brood range)**  
**Pipelines and water storage tanks**  
**Brush management for wildlife**  
**Establish perennial vegetation on circle irrigation corners**  
**Fencerow/field border cover management**  
**Establish perennial vegetation on terraces**  
**Conservation tillage/no-till farming practices**  
**Manage prairie dog towns with technical assistance**  
**Manage beavers with technical assistance**  
**Retain/enhance Conservation Reserve Program cover**

Erosion Control

Seed waterways and critical areas (erodible)  
Roadside management for ground-nesting birds  
Prescribed grazing systems for wildlife  
Riparian management for wildlife  
Prescribed burning systems for wildlife  
Reseed mixed-grass prairie with native mixes  
Brush management for wildlife  
**Woody cover, establish multi-row shelterbelts**  
**Woody cover, renovate old shelterbelts**  
**Woody cover, establish shrub mottes**  
Establish perennial vegetation on circle irrigation corners  
Fencerows/field borders seeded to perennial cover  
Establish perennial vegetation on terraces  
Conservation tillage/no-till farming practices  
Manage beavers with technical assistance  
Maintain Conservation Reserve Program cover

Predator Control/(Management)

**Predator management (coyotes, feral hogs)**

Providing Supplemental Water

**Provide windmill overflow water**

**Develop ponds/shallow water areas for wildlife**

Pipelines and water storage tanks

Riparian management for wildlife

Manage beavers with technical assistance

Providing Supplemental Food

Prescribed grazing systems for wildlife

Riparian management for wildlife

Prescribed burning systems for wildlife

Annual disking to promote forbs

**Annual food plots (cereal grains)**

**Perennial food plots**

Brush management for wildlife

Woody cover, establish shrub mottes

**Protect old homesites, farmsteads**

Establish perennial vegetation on circle irrigation corners

Fencerows/field borders seeded to perennial cover

Conservation tillage/no-till farming practices

Manage beavers with technical assistance

**Aquatic vegetation management**

Providing Supplemental Shelter

Seed waterways and critical areas (erodible)

Roadside management for ground-nesting birds

Prescribed grazing systems for wildlife

Riparian management for wildlife

Prescribed burning systems for wildlife

**Improving mesquite cover by half-cutting**

Brush management for wildlife

**Create artificial shelters**

Woody cover, establish multi-row shelterbelts

Woody cover, renovate old shelterbelts

Woody cover, establish shrub mottes

Protect old homesites, farmsteads

Establish perennial vegetation on circle irrigation corners

Fencerows/field borders seeded to perennial cover

Establish perennial vegetation on terraces

**Construct/erect artificial nest structures**

Manage beavers with technical assistance

Aquatic vegetation management

Maintain Conservation Reserve Program cover

**Cottonwood pole plantings (riparian)**

Census (Population/Surveys)

**Big game annual population surveys**

**Big game harvest management (restrictive)**

**Big game harvest record-keeping system**

**Note:** All practices could be implemented on existing or new CRP contracts, so long as there is no conflict/violation of USDA regulations.

## Appendix D

# Livestock Management Recommendations

**A** *planned grazing system* is the single-most important tool for improving wildlife habitat on rangelands in the High Plains and Rolling Plains. Stock cattle at the NRCS (formerly SCS) recommended rate and where possible, rotate cattle in one herd through multiple pastures, letting pastures rest for at least as long as they are grazed. A single electric wire fence 30 inches above the ground is also usually enough to



discourage cattle access, but permit deer easy access. Cost of electric fencing, using a solar charger-powered battery, is about one-third cost of barbed wire fencing.

Grazing Management Plan should include:

Kind of Livestock: Brahman, Hereford-Brahman Cross, Angus, etc.

Type of Livestock: Cow/calf, Steers, etc.

Stocking rate: One animal unit per \_\_\_\_\_ acres.

Type of Grazing System: Two Pasture, Eight Pasture, Planned Deferment 1-2 years, etc.

Intensity and Duration: High Frequency-Short Duration, Controlled Grazing, etc.

Because "weeds" (broadleafed herbaceous plants) compete with grasses for growing space, nutrients, and moisture, their presence in rangeland plant communities is usually considered to be undesirable by most range managers, but they are important for wildlife. A well planned livestock grazing system allows for a greater plant diversity, including a good component of forbs.

A range that has not been grazed for a long period of time, and is otherwise not periodically disturbed, can "stagnate" by becoming dominated by relatively few species of plants and exhibit limited variety and diversity. Therefore, total long-term deferment from livestock grazing is not normally recommended for optimum range and wildlife habitat management. Several growing seasons of deferment may be needed to allow an abused range to recover, but grazing should again be implemented after sufficient recovery is made.

Livestock should be considered as "tools" that can be used to maintain good wildlife habitat. A well-planned livestock grazing system is one which allows adequate rest

periods for plants to recover after grazing. Most domestic livestock are selective grazers and consume the most nutritious and palatable plants first. Whenever a plant is eaten, there is not only a reduction in top growth but also a reduction in root growth. This reduces the plant's ability to rapidly regrow following defoliation. During the growing season, herbaceous plants need at least 30 to 60 days of rest to recover from grazing. Woody plants need as long as 4 to 6 months of rest to allow for regrowth. The recovery periods depend upon the severity of defoliation, moisture conditions, and temperature.

During continuous year-long grazing when livestock are left in a pasture for 365 days of the year, the most palatable plants are repeatedly defoliated. Frequent, repeated use will not allow seed production or plant recovery. Continuous grazing, even at light to moderate stocking rates, will remove the most desirable and palatable plants while the least preferred/least palatable plants that receive less grazing pressure become more dominant because of a reduction in competition. The result is a change in the species composition and an overall reduction in plant species diversity. Continuous grazing should not be used as a grazing method if the land manager's desire is to improve habitat for wildlife.

Several livestock grazing methods and systems have been developed which provide adequate periods of rest and allow vegetative recovery. There are many variations of these systems and the land manager needs to select the one that fits his particular situation. Some commonly used deferred-rotation grazing systems are: two pasture/one herd rotation, three pasture/one herd rotation, four pasture/one herd rotation, high intensity/low frequency (HILF), short duration, and four pasture/three herd rotation. Regardless of the type of deferred-rotation grazing system used, the length of time that an individual pasture should be grazed, and the length of time that it would



need to be rested before being grazed again, would be dependent on the size of the pasture, its grazing capacity, the time of year (growing season versus non-growing season), the amount of rainfall received since being grazed, and the class of livestock. Grazing schedules and livestock stocking rates for pastures within a grazing system need to be flexible and continually reevaluated based on rainfall patterns, seasons of the

year, and local range conditions. Knowing how long to graze and how long to rest is more an art than a science, dependent more on environmental factors and the on-site conditions than on the calendar.

Below are brief descriptions of the different deferred-rotation grazing systems. There are many variations of each system and the land manager can modify the grazing

schedules to fit the local situation.

Two pasture/one herd rotation - All livestock are confined to one pasture, which is grazed for 3 months. The herd is then moved to the second pasture, which is grazed for 6 months. The herd is then moved back to the first pasture for 6 months, then back to the second for 3 months, and so on, continuing with the 3 month/6 month cycle.

Three pasture/one herd rotation - The one herd of livestock is rotated through the pastures every 3 months. This allows each pasture to receive 6 months of rest before being grazed again. Over time, the pastures are grazed during different seasons of the year, with a 3 year interval before an individual pasture is grazed during the same time period again. For example, a pasture grazed from April through June during the first cycle, would be grazed from January through March during the second cycle, October through December during the third cycle, and July through September during the fourth cycle, before being grazed again during the April through June period during the fifth cycle.

Four pasture/one herd rotation - The one herd of livestock is rotated through the pastures every 2 months. Each pasture also receives 6 months of rest before being grazed again, but the interval before an individual pasture is grazed again during the same time period is reduced to 2 years. For example, a pasture grazed April and May during the first cycle, is grazed December and January during the second cycle, and August and September during the third cycle, before being grazed again April and May during the fourth cycle.

High intensity/low frequency (HILF) - The number of pastures in this system is variable, but typically requires a minimum of 6 to 8 pastures. The livestock are kept in one herd, and each pasture is grazed intensely by the entire herd for approximately 1 to 1 1/2 months (high intensity), followed by a long period of rest (low frequency). The following are the calculations for determining how long each pasture should be grazed under a HILF system, using a system with 7 pastures as an example:

- 1.) add 1 to the number of pastures in the system ( $1+7=8$ )
- 2.) divide the number of days in a year by the answer from step 1 to determine how many days each pasture should be grazed ( $365 \text{ days divided by } 8 = 46 \text{ days of grazing per pasture}$ ).

It would take 322 days ( $7 \text{ pastures} \times 46 \text{ days each} = 322 \text{ days}$ ) to complete the grazing cycle, and each pasture would receive 276 days of rest between grazing periods.

Short duration system - This system requires that a ranch be divided into numerous pastures, typically a minimum of 12 to 20. The livestock are kept in one herd and the herd is rotated rapidly through the pastures. Each pasture is grazed intensely for a short period of time (a few days), followed by several months of rest. The length of the grazing cycle needs to be based on the season of the year and the amount of rainfall received during the cycle. For example, a 90 day cycle could be used during the growing season when plants recover more rapidly after being grazed. Each pasture in a



short duration system that has 15 pastures, for example, would be grazed for approximately 6 days each (90 days divided by 15 pastures = 6 days per pasture) during the spring and summer growing season. The grazing cycle would be completed in 90 days. Each pasture would receive 84 days of rest between grazing periods, which would hopefully be enough for sufficient plant recovery if adequate rain was received during the cycle. The cycle could be lengthened during the non-growing system when dormant warm-season plants can withstand heavier grazing pressure without damage. Each pasture in the 15 pasture system would be grazed for 10 days at a time under a 150 day cycle used during the winter, with 140 days of rest between grazing periods.

Four pasture/three herd rotation - The livestock are divided into 3 herds and stocked within 3 of the 4 pastures. One herd is moved to a vacant pasture every 4 months. This allows for an individual pasture to be grazed for 1 year and rested for 4 months. The four pasture/three herd system is the least preferred because of the long period of time that livestock remain in each pasture.

A ranch must be divided into at least two pastures before even the least complex two pasture/one herd deferred-rotation grazing system can be implemented. If not cross-fenced, the land manager would need to have access to other areas where livestock could be moved to during the prescribed rest periods. Electric fencing is a lower cost/less labor intensive alternative to barbed wire for dividing a ranch into multiple pastures. For a deferred-rotation grazing system to be most effective, all the pastures in the system should be more or less equal in size and/or have similar grazing capacities (e.g., pastures on the most productive, deep soils of a ranch would have higher livestock grazing capacities and should therefore be smaller than pastures on shallower, less productive soils).

Individually fenced improved grass pastures on a ranch should be incorporated into a deferred-rotation grazing system. Rotating livestock through the tame grass pastures would help provide longer/more frequent periods of deferment for the native pastures since most species of non-native forages can generally withstand more intensive grazing pressure than native plants can. Note: most species of "improved" livestock forages (such as weeping lovegrass, Klein grass, Old World bluestem, etc.) do not have much value to wildlife, except possibly as cover for some species, especially if grown in dense monocultures with very little diversity of native plants.

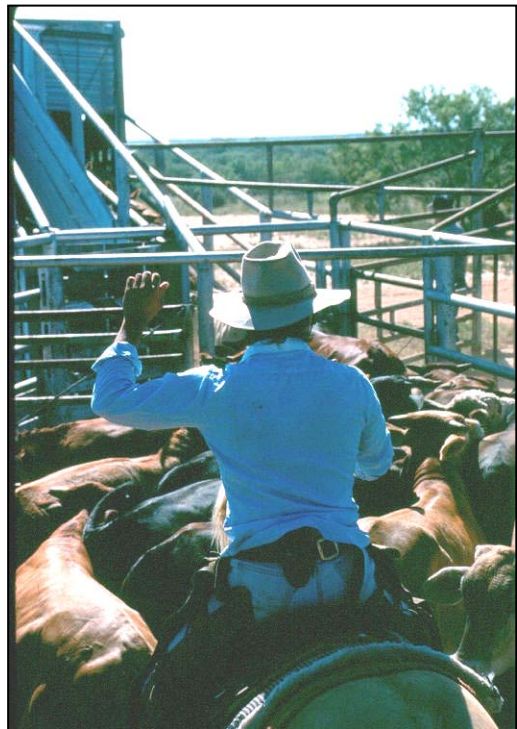

Since livestock are confined to individual pastures in a deferred-rotation grazing system,

each pasture needs to have at least one source of water available when livestock are in that pasture. Creeks may provide adequate water during most of the year, but water from seasonal streams may become limited or inaccessible during extended dry periods. Also, concentrated livestock activity around creek waterholes can cause excessive damage to the plants and soils in the area. Earthen stock tanks and/or water piped to troughs from a well may provide better, more reliable, sources of water. One water source can serve several pastures if properly located. For example, one water trough could serve two pastures if straddled by a cross-fence, or a trough in a separately fenced "waterlot" constructed at the juncture of several cross-fences could serve numerous pastures.

A deferred-rotation grazing system will fail to produce the desired results of maintaining a healthy and diverse plant community if the range is overstocked with animals, both domestic and wild. The appropriate livestock stocking rate for a specific ranch is dependent on that ranch's herbaceous plant productivity and past grazing history. The stocking rate can vary from year to year, and seasonally within a year, depending on environmental factors. Stocking rates should be calculated on grazeable land, excluding dense woods or brush, or water. The impact of grazing animals should be closely monitored and the number of livestock on a ranch may need to be frequently adjusted to account for the variations in a ranch's grazing capacity. A rule-of-thumb livestock stocking rate for native grasslands in the High Plains and Rolling of Texas is 1 animal unit (a.u.) per 35-40 acres. The combined total of all animals on the range, including all classes of livestock as well as deer, must be considered when determining stocking rates. The following equivalent values of animal unit standards can be used for planning the management of rangelands:

The combined total of all animals on the range, including all classes of livestock as well as deer and exotics, must be considered when determining stocking rates. The following equivalent values of animal unit standards can be used for planning the management of rangelands:

Cattle

weaned calves to yearlings	0.6 animal unit
steers and heifers (1 to 2 years)	1.0 animal unit
mature cows, with or without unweaned calves at side	1.0 animal unit
bulls (2 years and over)	1.3 animal unit

Goats

6 weaned kids to yearlings	0.6 animal unit
6 muttuns or does (1 to 2 years)	1.0 animal unit
6 does, with or without unweaned kids at side	1.0 animal unit
6 bucks or muttuns over 2 years	1.3 animal unit

Horses

1 – 1.5 animal unit

Deer  
6 deer

1.0 animal unit

A well-planned cattle grazing system is compatible with wildlife habitat management. Since cattle primarily consume grass, they do not normally compete with most wildlife for the same food sources, unless forced to due to excessive stocking rates and/or continuous grazing pressure. However, goats and sheep more directly compete with wildlife. Goats prefer browse (the foliage of woody plants); sheep prefer forbs. The foliage and seeds of forbs and woody plants are important food sources for many species of wildlife. Excessive goat browsing also reduces the amount of low-growing woody brush needed for cover for many wildlife species and can limit the reproduction of woody plants. It is recommended that sheep or goats not be stocked on a ranch if maintaining and improving the habitat for wildlife is an objective, unless 4-6 months rest can be periodically provided in pastures to allow for the adequate recovery of woody plants.

It is recommended that when leasing grazing rights, there be a written livestock grazing lease agreement that as a minimum specifies a maximum stocking rate and that a rotational grazing system will be used. Grazing schedules (how long each pasture will be grazed and how long each will be rested) and stocking intensities need to be flexible and continually reevaluated based on rainfall patterns, seasons of the year, and local range conditions. The landowner needs to retain the rights to require the lessee to reduce, and in some instances increase, the number of livestock depending on range conditions, and to require that range plants receive appropriate periods of rest. As a suggestion, it may be to the landowner's benefit to receive grazing lease "payment" in the form of facilities/habitat improvements (fence repair, additional cross-fence construction, cedar control, prescribed burning, discing to encourage forb growth, etc.) in lieu of monetary reimbursement. A good, trustworthy lessee can be an asset to a landowner, helping to maintain and improve the quality of the habitat as well as serving as the landowner's "eyes and ears" in his absence. Conversely, a lessee who is more concerned with maximum, short-term economic gains rather than the long-term sustained health of the land can be a liability.

## Appendix E

### Vegetation Management Recommendations

Examples of cover requirements for High Plains and Rolling Plains wildlife are:

- **Pronghorns** prefer open grasslands\* and need fawning cover (taller grass/forbs in spots) without heavy woody cover (less than 10% canopy coverage);
- **White-tailed deer** in agricultural areas need protective cover afforded by Conservation Reserve Program (CRP) lands\*, and are favored in areas of heavier woody cover (up to 75% canopy) associated with river breaks;
- **Mule deer and elk** are favored in areas of open grasslands\* interspersed with rough canyonlands\*, CRP\*, and agriculture with a canopy of 15-40% woody cover;
- **Bobwhite quail** need areas of bare ground interspersed with protective overhead woody cover (25% canopy), nesting cover of midgrass (bluestem), and brood range with forbs (weeds) often found in draws with sandier soils;
- **Scaled quail** have similar habitat requirements as bobwhite quail, but do well with much less woody canopy cover (10%); they occur on hardland sites as well as sandy sites;
- **Rio Grande wild turkeys** require protected roost sites (usually 30% mature timber in the form of upland shelterbelts\* or cottonwoods\* in river bottoms), nesting cover in the form of brush piles/tall grass on uplands sites, and rely heavily on agricultural crops adjacent to these sites;
- **Lesser prairie chickens** need extensive tracts of mid-grass prairie\* with perennial bunch grasses (i.e. sand bluestem, little bluestem) and woody cover (30%) made up of sand shinnery oak, plum thickets, sand sage, and/or aromatic sumac, interspersed with native forbs;
- **Neotropical migratory bird species** such as killdeer, American kestrel, American avocet, long-billed curlew, Mississippi kite, scissor-tailed flycatcher, Swainson's hawk, and lark bunting benefit from grasslands\* and a mosaic of cover types created by planned grazing and cropping systems that incorporate crop rotation and *reduced tillage*; and,
- **Ring-necked pheasants** need a 30% canopy of heavy grass/weed cover for winter protection and nesting in the form of unmowed roadsides\*, CRP fields\*, odd corners\*, field borders\*, and undisturbed playas\* interspersed with clean ground (brood range) and grain fields (60% stubble left standing for food/cover in winter).

In short, a variety of diverse cover types within a farm or ranch boundary generally

promotes greater wildlife diversity; however, the habitat needs, home range, and mobility of particular species must be taken into account when planning enhancements for wildlife in order for reasonable goals/expectations to be realized.

**\*Important sites/elements to retain and manage**

Management of vegetation, whether it be shortgrass prairie, midgrass prairie, Conservation Reserve Program lands, canyonlands, or riparian zones, requires long-term planning. Any vegetation manipulation practice will have an impact on resident wildlife species, either good or bad, depending on the type of treatment used, the degree of use, and location. Before implementing vegetation control techniques, determine what the long-term effects will be for each wildlife species that occurs in the area and minimize the negative impacts. Consider the location and size of sensitive wildlife habitats that provide important nesting or roosting sites, feeding areas, desirable wildlife food producing plants, cover, water, and space needs. Wildlife can be displaced by disturbance from an area without adequate escape or security cover. The amount and distribution of cover on adjacent lands need to be taken into consideration when assessing the cover needs of wide-ranging wildlife species such as mule deer, pronghorns, lesser prairie chickens, and Rio Grande wild turkey. A small ranch would need a larger amount of security cover on a percentage basis than would a larger ranch where the vastness of the area provides security.

The control of plant species such as redberry juniper, mesquite, prickly pear, that invade a variety of rangeland sites is often warranted. When these species dominate an area, they diminish plant diversity and the quality of habitat for most wildlife species. Vegetation manipulation may be in the form of prescribed burning, mechanical, biological, or chemical control of trees, brush, or weeds. Most of these practices will require the use of specialized equipment or machinery for plowing, discing, bulldozing, spraying, or other vegetation or soil manipulation procedures. The cost effectiveness of the different control measures must be considered prior to initiation of control measures.

Prescribed burning is an effective, low-cost habitat management tool that can be used to enhance plant diversity by stimulating the production of a variety of forb and grass species and to maintain woody plants at the low heights most beneficial to wildlife. Livestock as well as wildlife can benefit from a properly planned and conducted prescribed burn. However, there are legal



constraints and liabilities in the use of fire. The land manager should be well-trained and knowledgeable on the proper use of fire before attempting a prescribed burn. Refer to Texas Agricultural Extension Service bulletin *Prescribed Range Burning in Texas* for details on the use of fire as a range management tool.

#### Prescribed Burning Recommendations:

To enhance wildlife habitat on rangelands or Conservation Reserve Program lands, prescribe burn sites @ the rate of ¼th to 1/5th of the total acreage on a property during late-February through early-April (before green-up) on a rotating basis, burning each site every 4-5 years to remove old growth and stimulate new growth of forbs (weeds and wildflowers). In order to have enough fine fuel to produce a hot fire during cool-season burning, pasture deferment may be necessary to allow growth of vegetation normally grazed by cattle. See TCE publication entitled *Prescribed Range Burning in Texas* for good general guidelines, especially for native pastures. About seven times more insects are usually found in burned native grass areas compared to unburned areas, thus providing much more spring and summer high protein food for quail, wild turkey, prairie chicken, and/or pheasant poult.

General burn prescriptions for the High Plains and Rolling Plains habitats are:

1. Prepare disked bare-ground fire guard around all sites before burning. Disked fire guards, which can include roads and right-of-ways, should be 15 to 20 feet wide. (These disked areas can be planted to winter supplemental food plots between burn years.
2. Humidity should be between 25 - 40 percent.
3. Wind speed should be between 10 - 15 miles per hour.
4. Always burn into the wind first (backfire) 50 yards into the woods or pasture, then set fire with the wind (headfire). The entire burn may be conducted with a backfire, depending on fuel and weather conditions and burning experience of crew.
5. As a general rule, initiate burns in the morning, after 9 a.m.

Consult with TPWD, Natural Resources Conservation Service (NRCS, formerly Soil Conservation Service, SCS), or Texas Forest Service, and notify local volunteer fire department before conducting burns.

Cattle should be excluded from burned areas for at least 3 months to allow regrowth of new, tender vegetation.

Prescribed burning is the cheapest, most effective habitat management technique for the Rolling Plains Ecological Area.

The use of mechanical equipment to control woody plants will typically result in an initial growth of forbs and annual grasses and the resprouting of many woody species. Soil disturbance associated with mechanical controls releases the natural seed bank found in the soil, increasing the quantity, quality, and distribution of plants beneficial to wildlife. However, without periodic follow-up treatments of fire, herbicides, or additional mechanical manipulations, and/or without proper livestock grazing management, these sites will eventually again become dense stands of regrowth brush and trees. Mowing (shredding) areas of herbaceous plants and/or low density woody plants is another form of mechanical treatment. Mowing should be postponed until after the peak of the nesting/young-rearing period of local ground-nesting birds and mammals. One-third of open areas can be mowed per year, preferably in strips or mosaic types of patterns, to create "edge" and structural diversity.

Biological control is the use of heavy grazing pressure by livestock such as goats to control or suppress woody plants and sheep to control herbaceous weeds. Long-term heavy grazing pressure by goats, which prefer woody browse but will also consume forbs, will eliminate all leaves from woody plants up to a height of four feet. The creation of this "browse line" and the resulting park-like appearance of the woody plant community will have negative effects on the wildlife species that also depend on the low-growing foliage of woody plants for both forage and cover. Heavy grazing pressure by sheep, which prefer forbs, will reduce or eliminate forbs that are also beneficial to wildlife. Under certain management goals, biological control of woody plants and forbs can be a legitimate practice if done correctly. ***However, it is not normally a recommended wildlife habitat management practice.***

The use of chemical herbicides can have a significant negative impact on many plant communities and may suppress or eliminate plants other than the target species. From a wildlife habitat management perspective, the use of herbicides is one of the least desirable methods of vegetation control. If herbicides are used, selective applications, rather than broad-scale applications, are recommended to avoid the elimination of plants that are important to wildlife.

### Mesquite Control

Mesquite is another woody invader infesting many range sites in northwest Texas. Its growth form varies from a multi-stemmed shrub to an upright tree. Adaptable to a variety of soil types, mesquite can colonize and dominate open rangelands, old fields, and other areas where ground cover has been reduced and fire eliminated from the



Use of helicopters to apply herbicide provides the convenience of aerial application with the added benefits of allowing precision application, virtually eliminating chemical drift, and allowing the landowner to selectively treat very specific areas.

environment. Mesquite sprouts from buds along a compressed, buried section of the stem called the "crown". Control by grubbing, bulldozing, root plowing, and chaining of mature-size trees has proven successful under proper soil moisture conditions. Several approved herbicides are also available for control. Shredding, on the other hand, or other practices that only remove top growth but do not involve removal of the crown is not recommended and may result in further sprouting. Any control planning should proceed with good common sense and a sense of aesthetics.

Mesquite seed pods are readily eaten by wildlife and livestock, resulting in the dispersal of undigested seeds across the landscape. Seeds may remain dormant for extended periods of time and germinate when the right conditions or soil disturbances occur. Young mesquites can quickly become established and grow rapidly, particularly when competition from other plants is reduced by heavy grazing pressure.

Like redberry juniper, mesquite does have some redeeming qualities. It provides seed pods that are a beneficial although sporadic food source, microclimates for cool season grasses and forbs that may be important to plant diversity, nitrogen fixing roots, and cover, that make its occurrence beneficial to many wildlife species.

Farming Practices: Delaying of haying in native grass pastures or Conservation Reserve Program fields (when permitted by specific plan) until after the first of July will usually avoid accidentally killing of young fawns or ground nesting birds.

Keep use of herbicides to a minimum. If necessary, spot spraying or "tactical brush management" is much preferred over broadcast spraying of some of the newer herbicides which last longer. Spray early in the spring while plants are still small, requiring less spray. Many "weeds" are important to wildlife.

To provide weed seeds (ragweed, croton, sunflower, partridge pea, trailing wild bean, etc.) that are the basis of quail, dove, and other seed-eating bird's fall and winter diets, shallow disk 10 - 20 foot wide strips in sandy soil around the edge of brush and woods after the first freeze. This practice will promote growth of these important forbs the following spring and summer. This treatment should always be conducted with the natural contour of the land on country with <3% slope to avoid erosion problems, and should be performed generally during the months of February-March in the Rolling Plains.



## Selected References for Deer Food Plants in West Texas\*

compiled by Calvin Richardson and Gene Miller  
Technical Guidance Biologists  
Texas Parks & Wildlife Department

Albertson, F. W. et. al. 1963. **Pasture and Range Plants**. Phillips Petroleum Company, Bartlesville, Oklahoma,. 176 pages.

Gee, K. L., Porter, M. D., Demarais, S., Bryant, F. C., and G. Van Vreede. 1991. **White-tailed Deer: Their Foods and Management in the Cross Timbers**. Samuel Roberts Noble Foundation, Ardmore, Oklahoma. 168 pages.

Halls, L. K. 1984. **White-tailed Deer Ecology and Management**. Wildlife Management Institute, Washington, D. C. 870 pages.

Hatch, S. L. and J. Pluhar. 1993. **Texas Range Plants**. Texas A&M University Press, College Station, Texas. 326 pages.

Kirkpatrick, Z. M. 1992. **Wildflowers of the Western Plains - A Field Guide**. University of Texas Press, Austin, Texas. 240 pages.

Powell, A. M. 1998. **Trees and Shrubs of the Trans-Pecos and Adjacent Areas**. University of Texas Press, Austin, Texas. 498 pages.

Vines, R. A. 1960. **Trees, Shrubs, and Woody Vines of the Southwest**. University of Texas Press, Austin, Texas. 1104 pages.

Warnock, B. H. 1974. **Wildflowers of the Guadalupe Mountains and the Sand Dune Country**. Sul Ross State University, Alpine, Texas. 176 pages.

Weniger, D. 1991. **Cacti of Texas and Neighboring States**. University of Texas Press, Austin, Texas. 356 pages.

\*\*\*\*\*

\*Compiled for the Deer Management 101 - From the Ground Up! Symposium held @ College Station, Texas on September 22-23, 1999, and pertaining to an area west of Interstate 35 and north of Interstate 20 in Texas

## APPENDIX F



# General Population Management Recommendations for Big Game

**P**ronghorn antelope, desert mule deer, white-tailed deer, and elk populations in the High Plains are adapted to specific habitats. Pronghorns are keyed to tracts of shortgrass prairie; mule deer are tied to interspersed canyons/grasslands, cropland/CRP habitat, and sandhills; white-tailed deer occur in areas of brush encroachment and cropland/CRP habitats. A small elk herd ranges throughout the breaks of Punta de Agua Creek and the Canadian River in Hartley and Oldham Counties. Weather and agricultural/range practices dictate quality and quantity of these habitat types and in turn influence productivity of these animals, especially pronghorns and deer. See guidelines for cover in *Vegetation Management Recommendations* as previously stated.

Agricultural crops (irrigated wheat, milo, and alfalfa) are important to pronghorns and deer, and do influence nutritional conditions during winter stress periods and gestation. Native browse plants are also preferred by deer and comprise a high percentage of their diet depending on availability. Mountain mahogany, aromatic sumac, littleleaf sumac, fourwing saltbush, sand sage, ephedra, shinnery oak, and hackberry are valuable where they occur in canyonlands, sandhills, or river break habitat adjacent to grasslands. Pronghorns and deer rely heavily on native forbs (broadleaf weeds) and legumes (nitrogen-fixing plants) and are not grazers in the sense that they *prefer* grasses; in fact, forbs comprise 60% of their diets. They will consume young tender shoots of grasses (5%) during periods of rapid luxuriant growth after prescribed burns and rainfall when palatability and digestible crude protein have increased, along with available forbs, browse (30%), and crops (5%). These percentages change seasonally depending on availability of preferred foods. Elk are mainly grazers (70% grasses) in the growing season, use browse during the winter, and can conflict with agricultural production when croplands occur in close proximity to rangeland.

Pronghorns are herd animals that traverse large acreages up to 10,000 acres. Desert mule deer and white-tailed deer in plains (fragmented) habitats tend to be more mobile with home ranges up to 5,000 acres. Therefore, the same animals can range on multiple landowners. Seasonal movements are influenced by rainfall, range conditions created/managed by livestock grazing, and cropland distribution. **Cooperative management** by neighboring landowners in an area affords the best opportunity to address 1) annual productivity/predation losses (coyotes eat fawns), 2) habitat management, and 3) harvest management. The figures stated above should be

considered minimum acreages for neighborhood "Wildlife Management Associations". However, management efforts will tend to be more productive (i.e. result in more wildlife for viewing, harvest, photography) when conducted over larger areas. Examples are a) entire county cooperates with Texas Animal Damage Control Service in predator control/management program to reduce pronghorn/deer fawn losses to coyotes on 100,000+ contiguous acres, b) landowners form a "WMA" to cooperatively share a limited number of buck pronghorn permits available within a herd unit boundary as opposed to individual permit issuance to landowners sharing the same animals, c) landowners form a "WMA" to improve wildlife habitat quality on large, contiguous acreages to benefit highly mobile species, and d) landowners form a "WMA" to achieve specific harvest management goals for mule/white-tailed deer, especially in low deer density/light harvest scenarios.

### Big Game Population Characteristics

Fawn survival for pronghorns (~25%), desert mule deer (~35%), white-tailed deer (~40%), aoudads (~30%), and elk (estimate ~30%) in the High Plains fluctuates with annual rainfall and habitat quality. Because nutritional condition is always marginal, productivity is generally low; therefore, recommended harvest for these species is conservative. To effectively conserve big game, pronghorn buck and elk harvest is provided for by TPWD-issued permit; mule deer buck harvest is by regulation, and white-tailed deer either-sex harvest is by regulation (see TPWD Hunting Guide).

### Method(s) Used to Determine Population Density and Composition:

In addition to survey information in the deer appendix, see the following: Aerial pronghorn surveys are conducted annually by Department wildlife biologists in fixed-wing aircraft. Herd composition information is collected by distinctive herd units and permit issuance is based on herd productivity and availability of surplus bucks. General population trend information on elk and aoudads is determined by landowner/game warden interviews.

### Recommendation for Harvest or Other Use:

Specific harvest recommendations *tailored to meet landowner/manager objectives* can only be made after surveys are conducted; however, the following guide may be used as a rule-of-thumb for High Plains big game:

- **Pronghorn antelope** - Buck harvest (only) is regulated by TPWD-issued permit; where smaller landownership occurs (~1-5 sections), **cooperative harvest management** by voluntary Wildlife Management Association is encouraged (contact TPWD wildlife biologist).
- **Desert mule deer** - To effectively conserve the resource, harvest bucks (only) legally as desired. To promote *improved buck quality* (>antler size and body weights), selectively harvest no more than **1 buck/3000 acres of deer range** each year. In areas of smaller landownership (~1-5 sections), **cooperative harvest management** by voluntary Wildlife Management Association is encouraged (contact TPWD wildlife biologist).

- **White-tailed deer** - To effectively conserve the resource, harvest bucks legally as desired. Harvest *adult does* where legal at no more than 1/200 acres of deer range. To promote *improved buck quality* (>antler size and body weights), selectively harvest no more than **1 buck/2000 acres of deer range** each year. In areas of smaller landownership (~1-5 sections), **cooperative harvest management** by voluntary Wildlife Management Association is encouraged (contact TPWD wildlife biologist).
- Elk - See TPWD Hunting Guide and consult with a Department wildlife biologist.

## Appendix G

# Specific Management Recommendations for White-tailed Deer/Desert Mule Deer

**B**efore entering into a discussion on the management of white-tailed deer, it should be noted that because of the large home range size of deer, adjacent lands are also included in the home ranges of many of the deer on a ranch less than 3,500 acres in size. Only those deer within the interior of a larger ranch may have home ranges located totally within the



ranch, while those in a wide band around the ranch's perimeter likely move back and forth onto adjacent lands. The quality of a ranch's deer population will in large part be dependent on the habitat quality and deer population management strategies (i.e. hunting pressure and deer harvest) found on the adjacent lands. In areas of smaller landownership within "plains habitats", it is important for landowners to work cooperatively to achieve deer/wildlife management goals. Formation of landowner wildlife management associations is a practical, workable solution. TPWD or TCE personnel can assist with formation of these WMA's.

### General:

The key to producing a productive and healthy deer population is dependent upon the quantity, quality, and variety of food plants produced by the habitat or range. Food availability can be improved by: (1) harvesting deer, including does\*, to maintain total deer numbers at or below the capacity of the habitat; (2) not stocking with exotic big game animals, or keeping their numbers at a low level, since exotics compete with deer for browse, forbs, and mast; (3) stocking the range with a moderate number of domestic animals (preferably species that do not directly compete with deer) and utilizing some form of a deferred-rotation system of grazing, and; (4) managing "noxious" woody vegetation with the cover needs of wildlife in mind (i.e. the production and availability of browse and forbs preferred by deer).

\*Mule deer doe harvest is generally much more restricted/not allowed due to low herd productivity in many areas throughout the High Plains and Rolling Plains

Understanding food habits of deer is fundamental to management. Studies have shown that deer prefer forbs and browse (leaves and twigs from trees or shrubs). Grasses make up a very small portion of a deer's diet and they are utilized only when tender and green. Deer cannot digest mature grasses. Forbs are generally high in protein and important to deer size, antler development, and fawn production. However the production, quality, and palatability of forbs is highly dependent on rainfall and the season of the year. Forbs will be absent or unpalatable at least during portions of a year, typically during late summer and late winter. Key browse plants occurring in northwest Texas include bumelia, netleaf hackberry, aromatic sumac, littleleaf sumac, mountain mahogany, redberry juniper (most utilized during winter), fourwing saltbush, lotebush, elbowbush, and ephedra. Sand shinnery oak produces mast (acorns) are readily eaten by deer, wild turkeys, prairie chickens, and other wildlife; however, production is erratic and therefore it is not as reliable as a food source as the foliage. Important mast producers are netleaf hackberry, western soapberry, bumelia, western dogwood (limited distribution), persimmon (limited distribution), bur oak (limited distribution), little walnut (limited distribution), and pecans, especially in association with river and creek bottoms where the moisture regime generally favors mast production. Important forbs include bladderpods, globemallow, primrose, doveweed, ragweed, crotons, ground cherry, spectacle-pod, nightshades, sagewort, plains zinnia, trailing ratany, and half-drop sundrop.

Antler development (main beam length, antler spread, basal circumference, and number of points) is dependent upon three factors: nutrition (quantity and quality of food), age, and genetics.

Nutrition: Nutrition can be optimized by the methods discussed above: controlling the numbers of deer and exotic ungulates, utilizing a rotational system of domestic livestock grazing with moderate stocking rates, and controlling noxious vegetation. Native perennial plantings and supplemental feeding\*, in conjunction with the above practices, can be used to help meet the nutritional needs of deer. Both practices will be discussed in more detail in a later section. See Appendix xxx entitled

\*Supplemental feeding *is no substitute* for a balanced habitat management program featuring enhancement of native food and cover through the use of tools such as planned grazing, prescribed fire, etc.

Age: Maximum antler development of buck deer is attained at 5 to 6 years of age. Allowing bucks to reach older ages through selective harvest will allow them to attain their potential antler growth.

Genetics: Spike antlered bucks are the result of inadequate nutrition, genetics, or a combination of these two factors. Research has shown that yearling (1 1/2 year old) bucks have the potential to produce 4 to 8 points as their first set of antlers if nutrition is adequate and they have the proper genetic background. Conversely, bucks may only produce spike antlers as yearlings if they have "spikes genes", even with adequate nutrition. Although the subsequent sets of antlers of yearling spikes generally will not

be spikes, their antlers tend to be inferior to those of bucks that were forked antlered as yearlings. Consequently, the incidence of inferior antlered bucks in the population should be minimized by the combination of optimizing nutrition (habitat management) and including spike antlered bucks in the total deer harvest.

Stocking deer from another area into a deer population in an attempt to introduce new genes and improve quality is a controversial and much discussed subject. The genetic contribution of 1 individual buck is limited where it is introduced into a population where other bucks are already present and also breeding does. There is no research available that indicates that introducing several bucks improves quality. Unless the pedigrees of the deer (bucks as well as does) stocked are known, there is a good chance that undesirable, but not easily recognizable, characteristics are being introduced. Stocking deer is costly. Also, the animals may have difficulty adapting to their new environment and mortality can be unusually high. It is much better to work with the resident population and cull bucks with poor antler characteristics and retain bucks with desirable characteristics. There are numerous examples where the "native" deer in a area where the average antler quality has been historically low have produced outstanding antlers through a combination of good habitat management, population management, and supplemental feeding. Deer within these populations had the genetic potential for large antlers, but were unable to express their potential because of inadequate nutrition and/or they were harvested before reaching mature ages.

#### Cover Requirements:

The best cover for either species of deer in "plains habitats" within the High Plains and Rolling Plains is a pattern or mosaic of woody brush and trees interspersed within open areas at an approximate 2:1 ratio of open area to woody cover. Clumps or strips of brush should be wide enough so that an observer cannot see through them from one side to the other during the winter months when deciduous species are bare of leaves. Cover strips should be as continuous as possible to provide travel lanes. Canyonlands interspersed with native rangelands and/or Conservation Reserve Program (CRP) Lands are very important to desert mule deer in both ecological areas; likewise, riparian woodlands interspersed with native range, crops, and CRP are important to white-tailed deer in the Rolling Plains.

#### Population Characteristics:

Maintaining the deer population density within the food supply is very important to prevent die-offs during extreme habitat conditions, such as during droughts. Maintaining deer numbers within the carrying capacity will improve fawn production and survival, increase body size and improve antler development, and prevent habitat deterioration from overuse.

Overuse of preferred vegetation on rangeland that is overpopulated with deer and/or overstocked with domestic animals on a long term basis can kill individual plants and prevent woody plant seedlings from being established, leading to a decline in the

carrying capacity.

The objective is to maintain deer numbers at a level where every deer in the population is receiving adequate nutrition without causing a degradation in the quantity and quality of native range plants. Factors such as fawn production, body size, antler development, and degree of browse utilization are good indicators to monitor to evaluate if a range is stocked at, above, or below its carrying capacity.

An unbalanced sex ratio favoring female deer results in a limited number of bucks available for harvest. Also, a surplus of does can contribute to a rapid increase in deer numbers with the potential for exceeding the carrying capacity of the range. The recommended sex ratio for a free-ranging deer (white-tailed and/or desert mule deer) herd in northwest Texas is 2-3 does per buck.

The fawn production objective is .75 fawns per doe or better.

#### Method(s) Used to Determine Population Density and Composition:

The spotlight deer survey technique is the primary method used to estimate population density (acres per deer). It can also be used to make an estimate of herd composition (buck/doe/fawn ratio).

Incidental daylight observations of deer should be used to improve herd composition estimates and for rating the quality of antlered deer. Daylight observations should be recorded by sex, age (adult or fawn), and antler quality (number of points, spread, etc.). Daylight observations can be made by slowly driving pasture roads during early morning and late evening hours. Hunters can also record observations of deer during the opening weekend of hunting season to supplement herd composition estimates.

The surveys should be conducted on an annual basis during the late summer and early fall (August 1-September 15), during the time of the year when bucks have identifiable antlers and fawns are old enough to be up and moving around yet still small enough to be recognized as fawns. Replicating the spotlight census 3 to 4 times during the annual census period will increase the sample size and improve the population estimates. A minimum of 100 daylight observations (or as many as practical) of deer should be recorded. Binoculars should be used to aid in identifying deer.

The aerial (helicopter) survey technique is another tool that can be used in northwest Texas. The greatest values of an aerial survey are the herd composition and buck antler quality estimates that can be made by observing a large sample size of deer in a short period of time. A total coverage aerial survey could be used periodically, perhaps every 3-5 years, to verify and support density, herd composition, and antlered buck quality estimates derived from annual spotlight surveys and incidental observations.

Biologists with the Texas Parks and Wildlife Department can provide assistance to establish the route(s), demonstrate the techniques, and help conduct the initial surveys.



The landowner/manager will then be encouraged to conduct all subsequent surveys and provide the data to the Department biologist for assistance in analyzing it and making harvest recommendations.

#### Recommendations for Harvest or Other Use:

Harvest is the key method to manage a deer population. It is utilized to maintain deer numbers within the carrying capacity, or food supply produced by the range. Harvest also is used to obtain and maintain a desired adult sex ratio and a desired age structure of the population by adjusting both the buck and doe kill.

Bucks: The harvest rate of bucks will be dependent on the objectives of the land owner/manager. Texas Parks and Wildlife Department has noted increased buck deer harvest in many areas of northwest Texas where agricultural land is interspersed with CRP, riparian, and canyon habitats. If 50% of the annual buck harvest is composed of 1 1/2 year old bucks (white-tailed deer or mule deer), heavy hunting pressure is indicated. If one of the deer management objectives is to improve buck quality (i.e. produce bucks with larger antlers and heavier body weights), they must be allowed to reach older ages, which means that the harvest of young, immature bucks should be restricted. Deer body characteristics, in addition to antler characteristics, should be used to determine the relative age of bucks "on-the-hoof." However, since many of the deer on a ranch will also roam onto neighboring lands, the benefits of not harvesting young bucks may be partially negated if these bucks are subject to being harvested on adjacent lands. For a deer population management program to be most successful in an area, most or all the land managers in the area must have similar deer harvest strategies, especially where smaller landownership and interspersed agricultural land exists.

Under a Quality Management strategy, buck harvest must be restricted to 20% or less of the estimated buck population. This limited harvest will result in low hunter success rates, but will permit a significant portion of the buck population to reach maturity (4.5 years old and older in white-tailed deer; 6.5 years old in desert mule deer) and increase the proportion of bucks in the population. This strategy may only have limited success on smaller tracts of land (5,000 acres or less that are not high-fenced\*) where hunting pressure on surrounding lands is moderate to heavy.

\*Should not be interpreted as a recommendation for high fences. *High fencing* requires a serious, long term commitment to a balanced program of habitat management and intensive big harvest management.

Under a Quantity Management strategy, up to 50% of the estimated buck population can be harvested annually to provide maximum hunter success. This strategy will result in a relatively young, immature buck herd, with most of the bucks harvested being 1 1/2 to 2 1/2 years old.

Under an Optimum Management strategy, 30% to 33% of the estimated buck

population is harvested annually to allow for a generally acceptable level of hunter success while restricting pressure on bucks that allows a portion of the buck population to reach older age classes.

The harvest of spike antlered bucks should be included in the buck harvest quota, not added to the quota, regardless of the management strategy used. Spikes may comprise from 20% to 50% of the total buck harvest quota. Harvesting spikes will remove poor quality bucks from the herd at an early age. Also, if spike antlered bucks comprise a portion of the buck harvest quota, hunting pressure will be reduced on the better quality bucks.

Does: The recommended doe harvest will depend upon the overall deer density, the estimated carrying capacity of the range, the observed sex ratio, and fawn production and survival.

Note: Specific harvest recommendations for both bucks and does should be made annually after deer censuses are completed.

#### Records Management:

Records should be kept to monitor the status of the deer herd and measure the success of management over time. As a minimum, record keeping should include:

- 1.) annual deer population data (survey data)
- 2.) number of deer harvested annually
- 3.) biological data from deer harvested, to include:
  - a.) field dressed weight
  - b.) antler measurements: inside spread, number of points, main beam lengths, circumference of antler bases. The Boone and Crockett antler scoring system can be used to measure overall antler quality.
  - c.) age: the manager can age the deer at the time they are harvested or the lower jaws can be removed from deer and stored for later aging by a biologist until the manager is proficient at aging.
  - d.) presence or absence of lactation (milk production) of does (to supplement fawn production estimates).

Note: Weight, antler, and lactation data from a deer, without knowing the age of the deer, is of minimum value. Conversely, age without corresponding weight/antler/lactation data is of minimum value.

#### Supplemental Feeding

Managing the habitat for proper nutrition should be the primary management goal. *Supplemental feeding and/or planting of annual food plots are not a substitute for good habitat management.* These practices should only be considered as "supplements" to the native habitat, not as "cure-alls" for low quality and/or poorly managed habitats.

This is not to say that deer do not use agricultural crops; on the contrary, agricultural fields are important to deer and other wildlife species in the High Plains and Rolling Plains.

Supplemental feeding is not a recommended practice unless it is integrated with other deer population/habitat management practices. It may be beneficial if the herd is harvested adequately each year and the range is in good condition. However, for deer feeding programs to provide sufficient additional nutrients to be of value requires considerable expense and long term commitment. The most popular feed used to supplement the diet of deer is corn, although it is one of the poorest types of deer feed available. Corn is low in protein (7-10%) and high in carbohydrates. It does not provide adequate protein levels needed for development of bone and muscle. Knowing these limitations, corn may be used: 1) as an energy supplement (carbohydrates) during very cold periods of the winter, and 2) to "bait" and hold deer in an area. If supplemental feeding is integrated into the overall management, the preferred method is to use a 16% to 20% protein pelleted commercial feed, fed free-choice from feeders distributed at the rate of one feeder per 300-600 acres located adjacent to adequate escape cover. In certain situations, feeder locations may have to be fenced to exclude livestock. Refer to the Texas Parks and Wildlife bulletin "Supplemental Feeding" for details.

### Annual Food Plots

Planting annual food plots with domestic grains *may be* a more effective method to supplement well managed native habitats than feeding, but like feeding, its cost effectiveness needs to be taken into account, considering factors such as climate, soil type, slope and drainage, labor, material, and equipment costs, and fencing from domestic livestock. Like feeding corn, annual food plots are typically used to bait and hold deer in an area. To provide optimum nutritional benefits to deer, the Texas Agricultural Extension recommends that 1) food plots comprise between 2% to 5% of the total land acreage, 2) one-half the plots be planted in cool season species (planted in early fall with forage available during winter stress periods) and one-half be planted in warm season species (planted in spring with forage available during the summer stress period), and 3) the plots be between 1/2 to 5 acres in size, long and narrow, and well distributed over the entire area adjacent to escape cover. Annual food plots should be planted on the deepest soils available.

*Cool season plantings* of domestic grains are generally more successful than warm season plantings if adequate rainfall occurs in the High Plains and Rolling Plains because weed competition is less of a problem. To provide a safe-guard against complete failure, it is recommended that a mixture of species be planted rather than planting a single species. A recommended cool season mixture is a combination of at least two of the following cereal grains: wheat, oats, and rye. All are annuals and will have to be replanted annually. Adding a cool season legume (alfalfa, sweetclover) to the seed mixture would increase the protein content.

*Warm season plantings* of domestic grains are generally less successful than cool season plantings. Typically, during droughty conditions when native vegetation is in

poor condition and supplemental plantings are most needed, there is not enough moisture for production of food plots. There is no one species that can be recommended for a warm season planting to supplement the diets of deer. Recommended warm season annual species are: spanish peanuts, grain sorghum, cowpeas, common sunflower. Most species of "improved" livestock forage grasses are not highly preferred by deer.

Supplemental food plots should be fenced to control livestock grazing so that the maximum amount of production is available for wildlife. It may also be necessary to control deer access into planted areas until the plants are well established (the perennial mix species may need protection for a full growing season), unless sufficiently large areas are planted so deer grazing pressure can be distributed.

### Perennial Food Plots

Unlike the undependable nature of annual plantings with domestic grain (non-irrigated), *seeding of native perennials* in conjunction with planned manipulation of native annuals by soil disturbance has a high probability of success, especially on nearly level, sandy loam sites in the Rolling Plains. For a discussion of a possible management scenario on rangelands, see the following appendix entitled *A Strategy for Management of Wildlife Openings in the Rolling Plains*.

## APPENDIX H

### A Strategy for Management of Wildlife Openings in the Rolling Plains of Texas

This strategy will fit a variety of soil types throughout the Rolling Plains Ecological Region. It is based on the following assertions:

- Encouragement of native plants and seeding of drought-hardy perennials yields more consistent results over the long term, especially in *dryland* situations;
- Openings/fields are fenced to be protected from cattle grazing;
- Openings/fields are treated *in thirds* with a perennial mix seeded in the middle 1/3 of each field;
- Equipment is available for seasonal treatments in portions of each field;
- All tillage operations are done *on the contour* on lands with <3% slope;
- Exotic plants (i.e. Johnsongrass, bermudagrass) are first *eliminated*; and
- The manager has a *commitment* to implement the technique and maintain a record of treatments.

Generally speaking, better results can be expected on bottomland sites because of >soil productivity and moisture availability. Longevity of perennials may be greater on bottomlands.

#### What this strategy will not do:

This recommendation is no substitute for favorable habitat conditions created by implementation of a *planned grazing system*. Even though this strategy includes highly palatable warm and cool season perennials with >digestible crude protein, it is not a "cure all" or "magic fix" for missing habitat components on a particular property. For example, ample brood range (bare ground) and food created for bobwhite quail in this scenario will not compensate for a lack of adequate nesting cover (bluestem clumps) and overhead screening cover (thickets of plum, bumelia, lotebush, shinnery oak) located in close proximity. Likewise, an increase in white-tailed deer, mule deer, or wild turkey production cannot be expected solely on the basis of instituting this technique without required amounts of escape cover (brush), water development, protected roost sites, nesting cover, and so forth. (*Note: As a general rule, if improving deer herd nutrition/increasing carrying capacity is a goal on rangelands, a minimum of 5% of the acreage* should be devoted to this strategy). Obviously, this technique will be more fruitful during years of timely rainfall in the growing season. There is *no substitute* for the effects of timely rains on vegetation and wildlife habitat in the Rolling Plains.

#### What this strategy will do:

Crop failures will be eliminated/minimized because of the production of native forbs by annual fallow disking in 1/3 of each field during late winter, seeding perennial forbs/legumes in 1/3 of each field in spring during the year initiated, with an option of plowing under a "green manure" crop in each field annually during late summer to

prepare for seeding a fall grain crop, *provided that localized rains occur*. This system will:

- allow the dedicated manager to avoid repeated failures by abandoning the "**milo mentality**" (in the Rollings Plains, when you **can** grow it, you don't need it...when you need it, you **can't** grow it);
- give each manager the flexibility to make decisions for fall seeding based on local weather;
- provide for rotation of spring/fall treatments on the *outside thirds* of each field for creation of a mosaic pattern;
- provide for cool season forbs (>wildlife nutrition) each year during spring/fall, even during droughts;
- provide for warm season legumes and forbs (>wildlife nutrition), even during droughts;
- help increase insect production during summer months in opening/fields that benefit songbirds, quail chicks, wild turkey poults (from legumes);
- improve soil fertility by increasing nitrogen fixation in the soil (legumes);
- create enhanced areas for *wildlife watching* and *dove hunting*; and
- demonstrate a *state-of-the-art* sustainable land management practice.

### **Step 1**

Eliminate any exotics such as Johnsongrass or bermudagrass following local recommendations from Texas Agricultural Extension Service and USDA Natural Resources Conservation Service. Cultural and chemical treatments may be required to eliminate these species while they are growing luxuriantly. In some cases, this step may take a full year.

### **Step 2**

Initially, deep plow each fenced opening/field **on the contour** in late winter (December-March). Hopefully, this will coincide with the long axis of established fields; however, no matter how fields are shaped, conduct all tillage practices **with the natural contour** of the land (for soil and water conservation). Use a moldboard or disc **plow** to turn vegetation under completely. Repeated discing to prepare seedbeds will only cause compaction, especially in tighter soils.

### **Step 3**

Divide each opening/field into **thirds** on the contour. Allow the outside thirds to remain undisturbed for response of native vegetation during the first year. During December-March, prepare the **middle third** for perennial seeding by discing several times until a firm but slightly rough seedbed is prepared. Using a **no-till drill with a legume hopper** (i.e. Truax or Tye), seed a pure live seed (PLS) *mixture* of the following natives very shallow (approximately 1/4 ") into a firm seedbed:

- **Eldorado engelmann daisy** - a cool season forb that reaches >25% digestible crude protein in the spring, knee high, @ 2-3# PLS/acre;
- **Maximilian sunflower** - a warm season forb from 3 to 9 feet tall at maturity with one or more stems and terminal heads, high in protein and a prolific seed producer, @ 1/3# PLS/acre;
- **Illinois bundleflower** - a warm season legume (nitrogen-fixer) high in protein and a heavy seed producer; knee to waist high, @ 2-3# PLS/acre;
- **Ranger alfalfa** - a cool season legume (nitrogen-fixer) high in protein and conducive to insect production for chicks/poults, @ 2-3# PLS/acre.

If you establish 1 clump or "hand" of this mixture every 3 square feet from initially seeding, *you have achieved a manageable stand*. Periodic mowing/**very light** discing in subsequent years during late winter with an application of low/no nitrogen fertilizer @ 100#/acre will strengthen root systems and encourage stand longevity. Some bare ground within these stands is desired for mobility and food accessibility for quail chicks, wild turkey poults, mourning doves, songbirds, rodents, small mammals, and lizards. Consult with your local TPWD wildlife biologist for local seed sources.

#### **Step 4**

In mid-August, check soil moisture in one of the outside thirds of each field to decide on feasibility of deep **plowing** "green manure" (crop of annual weeds) under to be later double-disked, fertilized @ 250#/acre of 10-10-10 in granular form, and seeded by grain drill ~September 1 to no less than 1 bushel/acre of wheat/rye/triticale for winter grazing by deer/wild turkeys and to provide green leafy material for other wildlife. If soil moisture is not adequate for seed germination, **do nothing** and allow that portion to remain undisturbed until late winter. Allow annual vegetation on the *opposite side* of the opening/field to remain undisturbed until late winter-early spring of the following year.

#### **Step 5**

In late winter (February-March), fallow disc (1-2 passes with an offset disc) the previous year's undisturbed outside third to a depth of 5"-6" for stimulation of annual native vegetation. (*Note: Depending on discing/plowing of outside thirds for annual forbs/fall grain seeding, a periodic chiseling treatment before discing may be necessary to prevent soil compaction, especially in tighter soils*). After treatment, allow that portion to remain undisturbed for response of native vegetation. If you seeded the opposite third across the field to a fall grain crop, **do nothing** and allow it to "seed out" during the summer. If grain was not seeded in the opposite third, fallow disc or deep plow that third again to develop another "green manure" crop for possible incorporation into a seedbed for fall grain if adequate moisture is available in mid-August. **At 1-2 year intervals, perform maintenance on perennial portion (middle) as described in Step 3 by ~March 1**. This will increase longevity of perennials up to >8 years. **Your management system is now in place. Flexibility and good records will ensure success!**

## APPENDIX I

# Upland Game/Small Game Population Characteristics and Harvest Recommendations

These species have high annual population turnover rates and high reproductive potential.

They cannot be stockpiled; therefore, liberal seasons and bag limits are not a concern to the wildlife manager through good/poor production years. Landowners may attempt to conserve game by curtailing hunts within the framework of seasons/bag limits if they so desire; however, this is moot because hunting *over the entire range* of these species in the High Plains is very conservative due to private landownership. Integration of winter food/cover plots, highly-diverse tall grass/legume nesting cover, and shelterbelts into farming operations promotes more pheasants; brush management featuring strips and mottes of sumacs, plum thickets, shinnery oak, sand sage, narrowleaf yucca (beargrass), mesquite, and cholla (tree) cactus favors scaled quail, bobwhite quail, wild turkeys, and rabbits. Preservation of little bluestem-sand bluestem-shinnery oak-sumac-plum thicket associations in sandhill habitat favors both quail species, wild turkeys, rabbits, and is critical for lesser prairie chickens. Availability of surface water and protected roost sites (shelterbelts on uplands and cottonwoods in bottoms) are the limiting factor for distribution of Rio Grande wild turkeys. Again, the best all-around wildlife habitat enhancement tool on High Plains rangelands is a ***planned grazing system that incorporates wildlife habitat requirements.***



The majority of pheasant roosters and wild turkey gobblers are harvestable surplus for the hunter's bag. Care should be taken to not hunt within 1/4 mile of turkey roosts. Wild turkeys are highly mobile and will move if harassed around these areas, especially in early morning/late evening.



## Appendix J

# Specific Management Recommendations for Bobwhite Quail

### Basic Habitat Requirements:

Bobwhite quail must have a year-round adequate supply of food and reasonable protection from hazards. This includes protection from predators while feeding, resting, loafing, roosting, traveling, and nesting, as well as protection from inclement weather conditions. Both food and cover supply must be stable or continuously renewed during the entire year. It is not enough that food and cover be adequate for 11 months, if either is lacking during a single month.



Food and cover must occur in a well-arranged pattern if they are to comprise quail habitat. The distance between a source of ample food and adequate cover must not be greater than bobwhites can negotiate with safety. As a rule of thumb, bobwhites venture no further than 200 yards from patches of cover. Ideally, escape cover should be linked to food supplies with more or less continuous screening cover. The screening cover must not be dense enough to prove an obstacle to the quail's short-legged gait. Overgrazed pastures do not provide adequate screening cover. Conversely, dense stands of thick grass monocultures cannot be easily negotiated. Without a suitable space relationship, a range will not be habitable for quail regardless of the quality or amount of food and cover present.

### Food:

Food supplies are usually most abundant during the spring and summer; seeds are ripening and insects and green plant material are available. The food supply begins to diminish at the time of the first killing frost in the fall, and continues to decline throughout the winter due to competition from other animals and from weathering. Seeds from forbs such as croton (doveweed), ragweed, sunflower, partridge pea, and many others are staple winter foods. A number of woody plants provide winter quail food. Fruits and mast such as plums, persimmons, sumac berries, hackberries, and gum elastic berries supplement quail diets. Most grasses, except for paspalums and panic grasses, do not produce seeds large enough to be worthwhile quail food. In general, forbs are the most important and most widely distributed sources of winter quail food. Green material from cool season forbs and grasses that germinate in the late winter if rainfall is adequate are essential to get quail in good body condition for the upcoming breeding season.

### Cover:

Bobwhite quail need several types of cover: screening overhead cover for security while feeding and traveling, "tangled" woody cover to retreat into to escape enemies, a "living room" type of cover for dusting or resting, and nesting cover. Roosting cover is also needed, but if other types of cover are present, the roosting cover requirement is usually adequately met.

Cover can take many forms and a patch of cover can meet several of the cover requirements.

A stand of broomweed, or similar tall plants with bushy canopies and an open understory at ground level, can provide screening overhead cover.

Thickets of low brush, trees, and vines can provide escape and loafing cover. In general, a habitat with between 5% and 15% canopy coverage of good woody cover is adequate, if it occurs in small, well distributed patches (no more than 200 yards between patches as discussed above).

Patches of residual grasses (i.e. little bluestem) left over from the previous growing season can provide nesting cover. Individual patches should be at least 8 inches tall and 12 inches in diameter (the size of a cake pan). Ideally, there should be more than 250 well distributed clumps of suitable nesting cover per acre, or 1 clump every 15 to 20 steps. Too little nesting cover makes it easier for predators to find and destroy nests.

#### Habitat Management Recommendations:

A primary quail management objective is to maintain or create the mosaic of small thickets of low growing woody brush throughout a ranch, as described above in woody cover requirements. Thickets of sumac, briars, plums, lotebush, shinnery oak, bumelia, cactus, narrowleaf yucca, etc. should be retained and encouraged to form. Although not as desirable, small clumps of low growing cedars could have some value as cover where other species do not grow or are in short supply. Where vines have grown up into a tree but it is too open at ground level to serve as quail cover, the tree can be cut half through a few feet above ground and pushed over, bringing the living vines closer to the ground. Young mesquite may be improved as overhead protective cover by selecting smooth-barked, multistemmed specimens, *half-cutting*, and pushing over to where the limbs touch the ground but they still continue to grow, forming small areas protected from cattle grazing/deer browsing. Half-cutting mesquite should be done during the early and middle parts of the growing season, not during the dormant season. The individual "skeletons" of large cut cedars can also form small areas protected from grazing/browsing where patches of herbaceous and woody plants suitable for cover can become established. The number of browsing animals on the range (combination of wildlife and domestic livestock) needs to be maintained at a level where browsing pressure on low growing woody cover is not excessive.

Another objective is to improve the amount and quality of herbaceous cover. A well-

planned deferred-rotation livestock grazing system (as described in the Livestock Recommendations section) can be used to create the patchy pattern of lightly grazed areas interspersed among more heavily grazed areas needed for nesting cover.

Most good seed producing forbs are early successional stage annuals that respond to soil disturbance that sets back plant succession. Discing the soil is a good practice that encourages the growth of forbs and other annual plants. Disced strips should be long and meandering and 1 or 2 disc widths wide. The same strips can be disced annually, or side-by-side strips can be disced on an alternating basis every other year to create adjacent strips in various stages of succession. The best plant response will occur in areas of deeper sandy, sandy-loam soils. It is important that disced strips be located near escape cover so they are useable by quail. Discing can be done anytime between the first killing frost in the fall and the last frost in the spring, but the optimum time is near the end of winter (January, February) shortly before spring growth gets underway.

Heavy spot grazing by cattle, such as occurs around salt blocks, feed areas, and water, causes soil disturbance that encourages forb growth. Salt blocks and feeding areas should be moved around the ranch to create small patches of disturbed ground.



Managing the habitat for the production of native food plants and cover should be the primary management goal. Supplemental feeding and/or the planting of food plots are not a substitute for good habitat management. These practices should only be considered as "supplements" to the native habitat, not as "cure-alls" for low quality and/or poorly managed habitats. Food plots and feeders alone will not increase the number of quail a range can support if the supplies of other required habitat elements such as cover are limited.

According to recent research in the Rolling Plains, prescribed burning has been found to be an effective, low-cost habitat management tool that can be used to enhance plant diversity by stimulating production of a variety of woody plants, forbs, and grasses. Burning can be used to remove rank stands of herbaceous vegetation and plant litter that hinder quail movements.

In summary, food and all the different types of cover must be available year around and suitably arranged to have a good quail habitat. The number of quail a range can produce and support will be dependent on the habitat element that is most limited. In other words, if cover is the limiting factor, increasing the amount of food beyond that needed for the number of quail that can be supported by the cover will not increase the range's quail carrying capacity, and vice versa.

See TPWD brochure 7000-37, Bobwhite Quail in Texas, Habitat Needs & Management Suggestions by A.S. Jackson, C. Holt, and D. W. Lay, and/or TPWD Bulletin #48, *Quail Management Handbook for West Texas Rolling Plains*, by A. S. Jackson.

Notes: The same types of cover and seed producing forbs and supplemental food plants utilized by quail are also utilized by many other species of birds and mammals. For more information on the effects of quail management on nongame species, see the following appendix.

# Managing CRP Lands for Quail in the High & Rolling Plains

by Gene T. Miller

Technical Guidance Biologist, Texas Parks & Wildlife Department

- Habitat quality for quail can be increased on lands seeded to permanent vegetation through the Conservation Reserve Program in the High & Rolling Plains of Texas. Monoculture stands, whether consisting of introduced or native grasses, typically lack diversity required for early-successional species like quail and can be improved by creation of a “patchwork” effect.
- Nesting cover (native warm-season grasses), brood habitat (bare ground, weeds, and insects), screening cover (like patches of broomweed), escape and loafing protective cover (like plum thickets), and food sources (like ragweed or carelessnessweed), are all important habitat components when provided in the right arrangement on the land.
- Optimum “patchwork” or **interspersion** for bobwhites and scaled quail (“blues”) in CRP fields (and native range) would be ~30-40% native grasses, forbs, and legumes in 5-20 acre patches; ~40-60% annual or perennial forbs (weeds) or food strips in 1-5 acre patches; ~5-20% in shrub cover in ¼ to 1 acre patches; and, ~5-40% in woodland in 5-20 acre patches. Scaled quail are generally favored by lower % brush canopy cover and a heavier grazing regime; therefore, they may derive principal habitat benefits from the edges of CRP fields adjoining native range.
- Appropriate use of habitat treatments like **fallow (winter) discing, prescribed (cool season) fire, interseeding of native forbs and legumes, establishment of annual food sources\***, **management of existing brush cover, establishment of native woody shrub cover, and periodic grazing (when authorized)** will yield the greatest results over time for managers who wish to improve CRP lands for quail. Benefits to other native species will accrue as habitat diversity increases.
- In general, managers will have to expend more effort and expense at modifying older, existing stands where introduced species were established during early CRP sign-up periods. Expired contracts offer tremendous flexibility to the quail enthusiast wishing to create optimum interspersion. Newer contracts (beginning with the 16<sup>th</sup> sign-up) will generally be more “quail friendly” while possibly lacking a key habitat component, i.e. woody cover. Read more about all techniques mentioned by obtaining a copy of **“Wildlife Habitat Management on Former CRP Lands”** (Management Note No. 14, 1994), available from the Range, Wildlife, & Fisheries Management Department @ Texas Tech University (806/742-1983).
- Free, non-binding, confidential technical assistance is available to land managers through TPWD’s **Private Lands & Habitat Program @ 806/655-3782**.

## Appendix K

# Guidelines for Native Grassland Restoration Projects

by

Jim Dillard, Technical Guidance Biologist  
Texas Parks and Wildlife Department, Mineral Wells

## INTRODUCTION

**N**ative grasslands and prairies, with their ecologically complex plant and animal communities, were an important component on the landscape of early Texas. They were dominant features on the landscape in the Edwards Plateau, Cross Timbers and Prairies, Coastal Plains, High Plains, and Lower Rolling Plains. They contributed significantly to forage production for livestock grazing and habitat for a wide variety of wildlife species. Most of the native prairies found in the Blackland Prairie and Coastal Prairie Regions of Texas have been depleted. Only isolated relic native prairie sites remain. Native prairies were also found within most of the other ecological regions of the state where adaptable soils site occurred. Soil that once supported these vast plant communities of native perennial grasses and forbs now maintain a thriving farming economy. Most of these lands are now devoted to the production of wheat, milo, corn, cotton, hay, improved pastures, and an array of other cash crops to meet our demands for food and fiber.



It is not possible to totally replicate the native grasslands and prairies that once existed in the different ecological regions of Texas. These guidelines, however, represent basic and fundamental techniques and procedures that should be addressed when attempting to restore or reconstruct range sites to resemble native prairie plant communities in Texas. Only with time can land truly evolve through the stages of natural plant succession to replicate the diverse flora and fauna characteristic of climax native prairies. There are land management steps that can be taken to speed up this process by reintroducing native plants or their cultivars on those lands that once supported native grasslands and prairies. Texas Parks and Wildlife Department recognizes the importance of native prairies and grasslands and their function as habitat for many wildlife species including native and migratory birds, small and large mammals, reptiles and amphibians, insects, and

invertebrates. Each ecological region will require different techniques, planting procedures, species selections, and site preparations to be successful. It will be imperative that a coordinated effort be made to draw upon the expertise of other agencies and groups with knowledge and training on native grassland and prairie restoration before undertaking a restoration project. Agencies such as the United States Department of Agriculture Natural Resources Conservation Service (NRCS), Texas Agricultural Extension Service, Soil and Water Conservation Districts, Native Prairies Association of Texas, Texas Parks and Wildlife Department, United States Forest Service, and universities are logical sources of information concerning the specifics to formulate grassland and prairie restoration plans. Many of these organizations have identified successful techniques and procedures through research and demonstration projects in different parts of Texas. No plan should be considered complete that has not taken into consideration the experience and knowledge already available from such sources.

The following outline covers most of the major elements that should be addressed in a grassland restoration plan. Many variables in techniques are possible and may be considered adequate if supporting evidence is presented to justify the approach to grassland and prairie restoration. As each site will be different, every effort should be made to identify specific techniques or steps that are applicable to each site.

## **GRASS SPECIES**

Native grasslands/prairies are diverse plant communities where 50 to 90 percent of the vegetation is grasses. They are the basic framework of the site and are associated with a wide variety of forbs or other plants. The more individual grass species planted, the better. However, initiation of a restoration project can include the initial planting of as few as four species for the site. Grasses planted, if from commercial seed sources, should be climax grass species for the ecological region of the state being considered and adapted to the soils found on the site. Sites may be suited to tall, mid-, or short grass species, depending on individual site classification or soil type. It may be necessary to plant different grass species on different locations of the site due to differences in soil type, moisture retention properties of the soil, PH considerations, or other microhabitat factors.

Selection of individual grass species to plant should be based on information obtained from the local NRCS or Soil and Water Conservation District (SWCD) office or other recognized source with knowledge about climax grass species of the area. Their range site descriptions will also be useful. Seed sources should be from within 300 miles of the site or nearer to assure adaptability and improve success of initial establishment. Grass seed will have a PLS (pure live seed) or germination rating which should be checked - the higher the better. Many commercial seed companies also will mix seed on request when ordering. Seed should be clean to improve flow through grass seed drills during planting. Soil type is also a factor to be considered when selecting grass species to plant.

## FORB SPECIES

Forbs or broadleaf herbaceous plants represent a major component of native grasslands/prairies and may be seasonally co-dominant. Annual and perennial species are found in native prairies and are responsible for the majority of species diversity. Planning native grassland/prairie projects should also incorporate initial introduction of a selected number of forb species. A plan should provide for the planting of at least four perennial species from the ecological region and adapted to the site. Range site



descriptions and climax vegetation check list from the local NRCS or other recognized source should be reviewed. The planting of additional species of annual and perennial species is encouraged as the site develops over time.

Annual forb species should not be introduced on the site until planted grass species become established. Establishment of grasses may require periodic mowing, at least initially, and will make establishment of annual

forbs difficult. Most sites will produce annual forbs and some perennials from existing seed banks in the soil. Annual forb diversity will increase over time. Annual forbs should not be planted during the first two years of the project.

A listing of seed sources for native grasses and forbs is also available from the National Wildflower Research Center in Austin. When ordering seed from any commercial seed dealer, always ask about the source of the seed you want. Be selective and shop around for seed availability when you will need it and the price you are willing to pay.

Native grasslands/prairies may also be reestablished using cut seed hay from an existing native prairie site. Seed can also be combined from an existing stand of native grassland. Techniques for planting seed obtained by these methods will be discussed. Annual forb seeds may also be collected by hand, stored to dry, and planted on selected sites throughout the life of the restoration project to improve plant diversity.

## SITE PREPARATION

Site preparation is perhaps the most important element to be addressed in planning a native grassland/prairie restoration project. The initial success of plantings will often be dependent on those steps taken to reduce weed competition, provide a suitable seedbed, and promote growth of seedlings. Competition by cool-season grasses and weeds will make initial establishment of native grass plants difficult and require site



management. Many of these plants are alien species and are undesirable in the completed project.

As each site will be different, an evaluation should be made to determine what existing vegetation complex is present and what steps will be necessary to set back plant succession so species planted can germinate and grow. It is important to determine the history of the site including past land use, crops grown, species of improved grasses planted, cultivation or other mechanical soil disturbances, herbicides used, etc. A check with the local NRCS or Farm Service Agency (FSA) office will be helpful. Aerial and topographic maps will help you evaluate the site to determine important features such as drainages, slope, or other physical features important in planning the restoration project. County soil maps should be closely reviewed during the early planning stages to determine soil types and adaptability of grass and forb species to be planted on the site.

One approach to grassland/prairie restoration is to plant forbs initially during the first fall period of the project and grasses during the late winter months of the following year. For a fall planting of forbs during October, the site must be prepared well in advance. Mowing and periodic light disking during the spring and summer months prior to planting will help set back germination and establishment of existing weeds and grasses. Shallow disking is recommended to avoid stimulating the existing dormant weed seed bank in the soil. Several diskings will be required initially and again just prior to planting. Application of an approved herbicide such as Roundup may be necessary on some sites prior to planting to control vegetation regrowth or undesirable species such as Johnsongrass, coastal bermudagrass, or cocklebur. A year's lead time is preferred for initial site preparation. Fire may also be used in initial site preparation to reduce rank vegetation.

A cover crop such as Haygrazer or other sorghum varieties may be planted on some sites to be restored during the summer, harvested in the fall, and the remaining stubble used to stabilize the soil surface for planting with grass seed drills. Not all sites require such plantings, depending on the individual site and strategy being used to establish grass and forbs. This technique reduces soil erosion by wind and water and may be necessary on some sites. Stubble should be left to a height of at least four inches.

Soil preparation specifications and guidelines for specific soil types and range classifications have been developed by the NRCS and are available at local SWCD offices.

## **PLANTING**

Preferred planting dates for perennial forb seed is during the fall, particularly the October-November period. Although most perennial forb species will not germinate until the spring, it is necessary that they undergo the chilling and softening process in the soil. Forb seeds may be planted with mechanical seed drills or broadcast spreaders, hand-carried seeders, broadcast by hand, or be mixed and incorporated with

grass seeds during the grass planting process. Most forb seeds require shallow planting depths into a firm seed bed. Forbs should not be planted earlier than the first freeze of the fall. Planting date information is also available from commercial seed dealers who provide recommendations for seed they sell. Planting dates will also vary, depending on what part of the state the site is located in. Native grass seed should be planted in Texas between January and April. Dry conditions during this period may substantially influence germination and growth of grass seedlings.

Seeding rates of commercial seed are available from the dealer. Seeding rate information for soil and range sites are also available from the local Natural Resources Conservation Service office. Seeding rate recommendations for pure stands of individual grass species may require adjustment to allow for planting of multiple species or mixes. Generally, a generous seeding rate for native grass species will improve the odds for a good stand the first year. Seeding rates will depend on the number of individual species being planted, type of equipment, and proportion of species desired in the final stand.

There are several types of equipment that are effective for planting grass seed. Grass drills are probably the best equipment and have greater reliability in establishing a stand. Grass drills are often available for use from local SWCD offices. Also, commercial contract farmers who specialize in grass plantings normally have this type of equipment. Common brand names are Tye, Nesbitt, John Deere, and Turax. Cultipackers are also used and consist of a seed box and roller system to pack seed into the ground. Seeds may also be planted by a fertilizer spreader followed by a harrow to work seed into the soil. Hand-held broadcast spreaders or those operated by small all terrain vehicles may also be used.

Seed hay taken from a native prairie site can be scattered over prepared ground by hand from a trailer, followed by a light harrowing to incorporate it into the soil. Prairie hay bales may be available and are easily stored. Such plantings should be done in the fall following the harvest of native seed hay. This method is not reliable because there is no guarantee that viable seeds have been produced and that germination will occur. Although native grasses may appear to have good seed production, only by conducting a germination test will you know if live seed are present and establishment of seedlings is likely.

Fertilization is optional during the initial planting of native grasses and forbs. It may serve to promote the growth of undesirable forbs and annual grasses and slow establishment of the desired species planted. Fertilization rates can be determined by soil analysis tests or based on recommendations from the NRCS or Texas Agricultural Extension Service.

Forb seed purchased from seed dealers should be specified as native, not domesticated seed. Mixes are generally not recommended unless they contain a desired species composition adapted to the region and are those species you want. Individual species plantings are preferred. One approach to seeding forbs is to mass

plant a variety of adaptable species and let the site, through the process of natural selection, determine where certain species will do best. A continuing effort should be made by the landowner to introduce additional forb species to the site as the project progresses over time.

## **SITE MANAGEMENT**

During the first year, growth of grass seedlings and perennial forbs may not appear impressive. Most growth of these plants will be below ground in the development of root systems. Annual weeds and other on-site grasses will respond to soil disturbances associated with initial planting operations. Mowing will be necessary during the first two years. Restoration sites should be mowed to a height of no less than 4 inches to reduce competition from annual weeds and undesirable grasses. It will also serve to reduce moisture loss from the soil. It may take 2 to 3 years growing time for native grasses to dominate the site vegetatively. Perennial forbs should respond sooner and become established along with annuals. Timing for mowing will have to be determined on-site and will require regular attention by the landowner.

Grazing is not recommended during the first three years. If vigorous growth of planted grass species does occur during this time, limited grazing during the dormant season may be possible. After three years, grazing may be incorporated into the management plan for the site by grazing during the growing season under a rest and rotation system. Grazing is not required for grassland/native prairie restoration projects; rather it should be used as a tool in their management.

Control burning is also a tool that can be used for site management. No burning should be conducted during the first three years after grasses have been planted. After that time, if the site has developed sufficiently and forage and thatch becomes excessive, burning on 3 to 4 year rotation can be initiated. Fire is a natural event for grasslands and prairies which benefit from its occurrence. Burning will stimulate growth of dormant forb seed, promote growth of above ground vegetation, improve soil fertility, and help control the invasion of undesirable woody plant species found in the area. Fire releases nutrients back into the soil and reduces shading of new grass and forb seedlings. Many new species will also germinate from the existing soil seed bank. Winter burns benefit warm-season dominant plants, whereas summer burns promote growth of cool-season plants. Depending on individual site management strategies, the use of prescribed burning, mowing, and grazing will be the primary tools available for site management of grassland/prairie restoration projects.

## **LITERATURE CITED**

Recreating A Prairie. National Wildflower Research Center, Austin, Texas.  
A Guide For Re-Creating Your Own Prairie. The Prairie Dog, Newsletter of the Native  
Prairies Association of Texas  
Wildflower Meadow Gardening. National Wildflower Research Center, Austin, Texas.  
Burlison, Bob and Micky. Homegrown Prairies. Reprint. The Prairie Dog, Newsletter

of the Native Prairies Association of Texas.  
Native Plant and Seed Sources of Texas and Oklahoma. National Wildflower Research  
Center, Austin, Texas.

## **SUGGESTED INFORMATION SOURCES**

USDA Natural Resources Conservation Service (local)  
Soil and Water Conservation Districts (local)  
Native Prairies Association of Texas  
3503 Lafayette Avenue, Austin, TX 78722-1807  
Texas Parks and Wildlife Department  
4200 Smith School Rd., Austin, TX 78744  
National Wildflower Research Center  
2600 FM 973 North, Austin, TX 78725  
Plant Materials Center, NRCS, Knox City, TX  
The Nature Conservancy of Texas  
P.O. Box 1440, San Antonio, TX 78295  
Texas Agricultural Extension Service (local)  
Native Plant Society  
USDA Farm Service Agency (FSA) (local)  
USDA US Forest Service  
USDA US Fish and Wildlife Service  
Texas A&M University/College Station  
Texas Tech University/Lubbock  
Texas A&M University/Kingsville  
Southwest Texas State University/San Marcos  
Sul Ross State University/Alpine  
East Texas State University/Nacogdoches  
Other Universities

## APPENDIX L

# EFFECTS OF QUAIL MANAGEMENT ON NONGAME SPECIES

Paraphrased from "Beef, Brush, & Bobwhites" by Guthery, pages 163-64:

"We studied response of nongame birds to bobwhite management on mesquite rangeland in the Rolling Plains. Management included disced strips, tepee and permanent brush shelters, half-cut mesquite and food plantings. For 1 year, we counted nongame birds on the managed site and on a similar site with no management. Nongame birds benefitted...there were more species and higher densities on the managed than on the unmanaged site in 10 of 12 months. With management, we increased the availability of seeds for any bird that eats seeds, not just bobwhites. Any time habitat diversity is increased, there is likely to be an increase in the number of species using the habitat...because the changes are made on a relatively small scale, you should lose no bird species. On the other hand, recommendations on grazing and brush management favor some species of nongame, but *do not* favor others. Birds or mammals that require dense brush are not adapted to the more open areas preferred for bobwhites. Birds or mammals that require high condition rangeland may not inhabit pastures in the lower condition required for bobwhites."



Paraphrased from "Interaction of Range Management or Nonmanagement with Wildlife Habitat and Wildlife" by Kozicky and Fulbright, pages 221-222:

Livestock Grazing: Researchers found that eastern meadowlarks were more numerous under moderate than under heavy grazing. Long-billed curlew numbers are significantly correlated with spring and fall grazing intensity. Arizona researchers stated that a grazed area supported significantly higher numbers of birds in summer, while densities did not differ in winter. Grazing appeared to favor birds as a class over rodents. In a study of four grazing treatments, bird species richness was highest under heavy short duration grazing (HSDG) and HSDG was the only system to show an increase in bird species diversity between years.

Brush Management: Researchers observed no difference in bird density, species diversity, or species richness...between untreated sites and sites later sprayed with herbicides to control mesquites. The density of mockingbirds was lower on treated than untreated areas, but no other species was affected. Habitat management to favor mourning doves and bobwhite quail was associated with a 54% increase in combined density of nongame birds. A researcher found that, as habitats changed from brush to

clearings, tree-foraging birds were replaced by ground-foraging species. Clearing brush at any intensity decreased total bird density but improved species richness and diversity relative to untreated areas.

Prescribed Burning: Researchers stated that the absence of the deliberate use of fire to control vegetation succession has done untold damage to prairie wildlife. Research found that ground-nesting lark sparrow nests were more numerous in the most recent burns and declined with increasing litter build-up.

Food for thought:

1) Should managers be concerned with improving conditions for single species or entire "systems"? *Comprehensive habitat planning and management will support more wildlife diversity.*



2) Can Conservation Reserve Program (CRP) land be managed for game and nongame wildlife? *Absolutely. See appendix entitled "Wildlife Considerations in the Management of CRP Lands" to understand how this works.*

3) The axe, fire, plow, cow, and gun are tools for the wildlife manager. Is "no manipulation" of habitat for a specified time a management option? *Absolutely. It is what range management specialists refer to as the tool of rest.*

Parting thought: The strength of the traditional wildlife management approach is that it explicitly uses and enhances *natural processes* to perpetuate populations.

Prepared by: Gene T. Miller, TPWD Technical Guidance Biologist

## APPENDIX M

# Specific Management Recommendations for Rio Grande Wild Turkeys



Rio Grande turkeys are present throughout the Rolling Plains in riparian areas and are limited in distribution within the High Plains by availability of protected roost sites and surface water. Fairly stable populations have been established in these counties due to suitable habitat, protection by private landowners, and restoration efforts by the Wildlife Division of TPWD. These populations are presently subjected to hunting during the regular fall and spring turkey season.

Although Rio Grande wild turkeys are non-migratory resident species, they have large home ranges that change with the season of the year. Turkeys tend to be widely dispersed during the spring and summer nesting/brood-rearing period. Nesting and brood-rearing habitat is similar to that required for quail, but on a larger scale: scattered thickets of low growing brush, patchy residual herbaceous vegetation, a moderately grazed, diverse grass/forb plant community that produces seeds and insects.

After the breeding season, numerous smaller flocks that were widely dispersed during the summer tend to congregate into large winter flocks. The ranges of winter flocks are centered around riparian areas (the floodplains of large creeks and rivers) that have moderately dense stands of tall, full canopied trees. These winter flocks will disperse several miles from their riparian area roost sites on daily feeding forays. Turkeys are attracted to feeders (not recommended for eastern turkey) and supplemental food plantings provided for deer and quail. The nearness of a ranch to a winter roost site(s), and the availability of a food source, would determine to what extent turkeys are present during the winter months.

Habitat management for the wild turkey concerns the availability of water, food, and cover. The distribution of these key components of the range is of major importance. Turkeys require water daily and can obtain water from foods or free water (ponds, creeks, rivers, etc.) Grassy or brushy nesting and brood-rearing cover is probably the most important cover requirement. Food availability of the native range can be increased by the following activities: (1) Moderately stock the range with domestic animals. (2) Utilize a deferred rotation system of grazing. (3) Control total deer numbers by harvesting does. (4) Prescribed burns can be utilized to increase production of forbs, grasses and fruit or mast producing browse plants. In summary, range management activities that increase the diversity of grasses, forbs, shrubs, trees, and vines improves

the habitat for the wild turkey. These same management practices are also beneficial to deer, quail, and many other wildlife species.

Preservation of roosting sites is a key factor to maintain a turkey population on a sustained basis. Turkey also need escape cover to travel to and from roosting sites. Mature trees utilized as roosting sites include , cottonwood, elm, hackberry, western soapberry, and large mesquite. Dense brush thickets or solid block clearing both furnish poor habitat for the turkey. Clearing programs that leave brush strips between cleared areas are advantageous. Avoid removing hardwood trees such as the various species of oaks, hackberry, elm, or large mesquite. If clearing is needed to improve the range, irregular shaped cleared strips that follow topography are best.

See the following appendix related to *riparian zones* in the High Plains and Rolling Plains of northwest Texas and their importance to Rio Grande wild turkeys and other wildlife species.

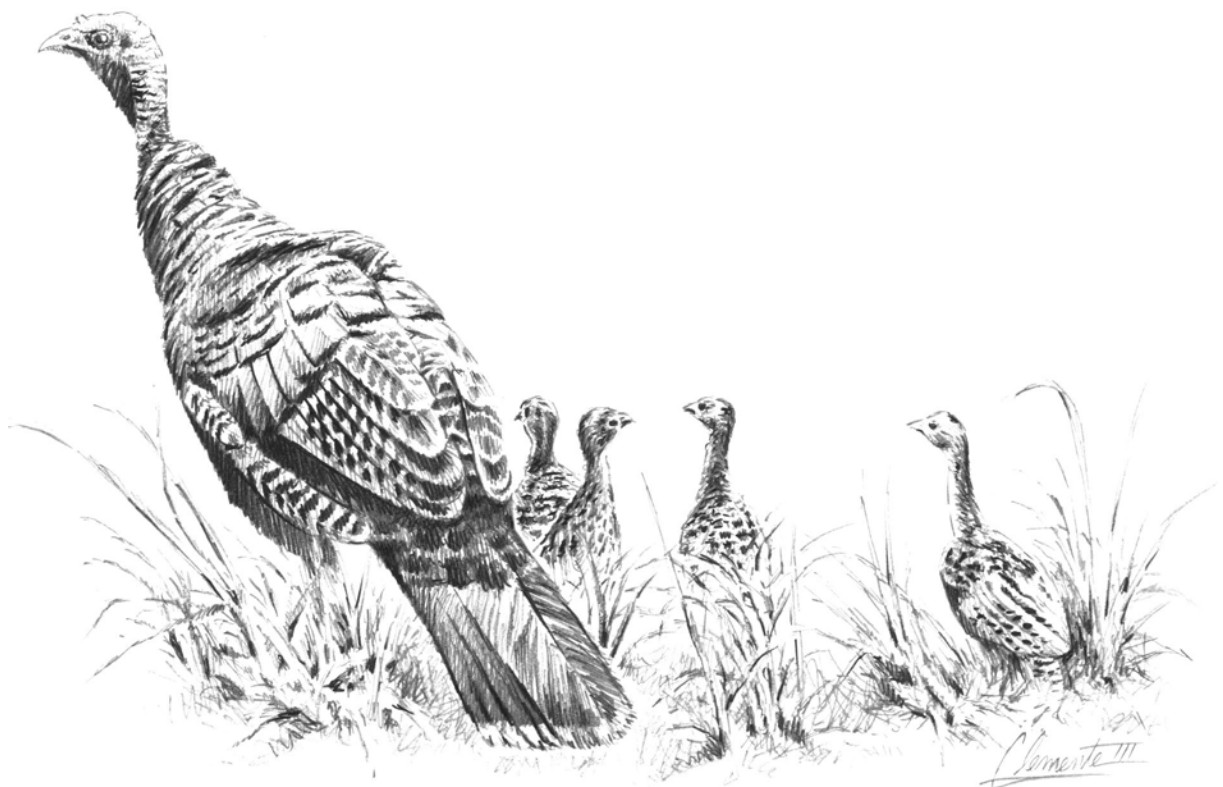



## APPENDIX N

# MANAGING RIPARIAN HABITAT FOR WILDLIFE IN NORTHWEST TEXAS

**R***iparian areas* are lands adjacent to streams and intermittent draws where vegetation is strongly influenced by the presence of water. This habitat type is especially important in northwest Texas due to presence of water and lush vegetation typically surrounded by harsher, drier, less productive environments. Even though they comprise only 2-5% of habitat in the Panhandle, these are some of the most productive wildlife areas. Riparian zones in the Rolling Plains can be likened to playas in the High Plains...wetland environments that are "oases" for wildlife. Examples are Wolf Creek, Canadian River, Washita River, Sweetwater Creek, and forks of the Red, Wichita, and Brazos Rivers. Common species are teal, mallards, pintails, wood ducks, mourning doves, wild turkeys, quail, opossums, fox squirrels, rabbits, coyotes, foxes, raccoons, skunks, bobcats, beavers, white-tailed deer, bald eagles (wintering), common snapping turtles, red-eared sliders, and yellow mud turtles. Neotropical (summer migrant) birds include Mississippi kites, kestrels, killdeer, western kingbirds, purple martins, swallows, robins, warblers, sparrows, flycatchers, buntings, and vireos. Overstory timber is typically cottonwood, with a mid-story of hackberry, soapberry, bumelia (chittam), persimmon, native pecan, western dogwood (limited), and understory plants like buttonbush, native plum, sedges, switchgrass, bluestems, native wildflowers, forbs, and legumes.



Key impacts to these riparian systems are dams, grazing, fire, and exotic plant invasion. Each impact deserves discussion; however, ***planned grazing systems*** may be the most important management tool available to the landowner for riparian conservation. Common sense points are:

- Each area has unique characteristics that must be accounted for in developing a grazing strategy. Cattle tend to prefer lush, green vegetation in riparian zones and therefore concentrate in these areas unless special management provisions are not instituted, i.e. fencing.

- No one grazing strategy fits all conditions.
- A grazing plan is only as good as the management that goes into it.
- Riparian pastures reduce management complexity and improve the odds and speed of achieving objectives.
- When grazing riparian areas with upland pastures, one or more of the following management techniques probably will have to be added to improve a *degraded* riparian area:

- Provide water, salt, and supplemental feeding away from riparian zones; herd to limit livestock use of riparian zones; add more pastures to increase management flexibility and increase rest for riparian zones.

Two basic approaches, from least to most complicated are:

- Exclude livestock from the riparian area with stream corridor fencing; or
- Put riparian areas in separate pastures to get tight control over the season, duration, and intensity of livestock use.

*You don't have to have all the answers before you get started!* A good manager can make almost any grazing strategy work, and a poor manager can make any plan fail. A single guiding principle for healthy riparian zones as part of grazing systems is *short grazing periods and long rest periods*. This generally promotes plant diversity and increased productivity for wildlife and livestock.

### **Systems Favoring Wildlife Habitat and Healthy Riparian Areas**

*Winter Grazing* - Graze when plants are dormant to provide rest during the growing season. This promotes plant vigor, seed, and root production. However; the manager must watch for damage to streambanks and overuse on previous season's growth on shrubs and trees. This is generally an excellent strategy for recovery of deteriorated uplands and riparian areas.

*Three-Pasture Rest Rotation Grazing* - This provides for grazing a pasture in spring the first year, summer the second, and rest during the third year. With attention to the degree of plant utilization, this system has produced good results for upland grasses. This is generally beneficial for sedge-rush-grass communities, but can be detrimental to riparian tree seedlings. Attention to woody species utilization is necessary for this grazing strategy to improve shrub and tree regeneration (i.e. fruit production, roosting habitat, loafing areas, nesting cavities, escape cover).

*Early Grazing* - Graze early during the growing season; early spring in cool season areas, early summer in warm season areas, if pastures can be designed to fit vegetation. This plan usually results in good dispersal of cattle and minimizes use of riparian woody plants. *Caution:* heavy grazing every year at this time can seriously

damage preferred plants. However, with management, this strategy has the potential to influence the development of riparian woody vegetation.

Help to get started is available from: ***Practicing landowners*** in the Panhandle, the USDA ***Natural Resources Conservation Service*** (field offices throughout the area), and ***Texas Parks & Wildlife Department*** (wildlife staff throughout the area).

Note: Some material adapted from *Managing Change: Livestock Grazing on Western Riparian Areas*, by the Northwest Resource Information Center, Inc., P. O. Box 427, Eagle, Idaho 83616.

## APPENDIX O

### **General Guidelines for Woody Plantings Used to Restore/Enhance Riparian Zones in the High Plains**

by

Gene T. Miller, Technical Guidance Biologist, Texas Parks & Wildlife Department

These guidelines were developed to aid landowners in planning for riparian restoration/enhancement projects involving establishment of native woody vegetation. They have been compiled from references and work done in similar habitats within the Southern Great Plains, and were designed to fulfill requirements of state and federal incentive programs. The author gratefully acknowledges input from Texas Forest Service, Texas Agricultural Extension Service, U. S. Fish & Wildlife Service, the USDA Natural Resources Conservation Service, and USDA Wildlife Services - Texas Wildlife Damage Management Program.

- For establishment of overstory timber, use native plains cottonwood (*Populus sargentii*) poles from the nearest available source and plant according to procedures in **Revegetating Southwest Riparian Areas** (Cooperative Extension Service, New Mexico State University) during January or February. Poles should be planted within 50 feet of a stream to have the best chance of survival (with water table fluctuation), and should not exceed a density of more than 10 trees per acre at maturity. (Plant @ 15 per acre with 70% survival expected; spacing between trees should be ~40-50 feet to allow for crown development at maturity with a height of 60-80 feet). The desired effect is to replicate mature cottonwood stands that are open, savannah-like, and irregularly-shaped. To achieve a natural appearance and improve wildlife habitat value, avoid planting in straight lines. Where possible, a tractor-mounted post hole digger and hand crew is recommended for installation during winter months. Pole plantings that are one (1) to five (5) acres in size are recommended as partial fulfillment of habitat requirements for most species.
- Individual poles should be protected from beaver damage by construction of circular barriers with room for growth expansion by using t-posts and heavy net-wire. This will also protect against cattle or hog damage caused by rubbing against poles during the first few years of establishment. For additional information concerning prevention of wildlife damage to plantings, contact USDA Wildlife Services (Texas Wildlife Damage Management Program) at 806/651-2880.
- For establishment of the fruiting, deciduous midstory component, use native species such as hackberry (*Celtis occidentalis*), little walnut (*Juglans microcarpa*), western soapberry (*Sapindus drummondii*), and roughleaf dogwood (*Cornus drummondii*). Plant in irregularly-shaped mottes (clumps) of at least 1½ acres in size, using a species mix\* containing at least 50 seedlings, located separate and away from cottonwood pole plantings. Spacing between seedlings should be at least 30 feet to allow for crown development at maturity, with expected heights ranging from ~30-50 feet. Establish a minimum of one (1) planting per 25 acres and a maximum of one

(1) planting per 5 acres. Plant during March-April using a tractor-mounted post hole digger, hand crew, fabric squares (@ 3 or 4 feet) and 2-3 gallons of water/seedling at planting time with a water tank. Seedlings should be protected from browsing animals with commercial tree protector tubes installed at planting time. \*Note: Little walnut also requires “wet feet” to survive; therefore, establish mottes with this species at the lowest possible elevation (closest to water table), nearby but separate from the developing cottonwood canopy. Hackberry, western soapberry, and roughleaf dogwood may be established in mixed stands further up slope (at higher elevations) within the riparian zone.

- For establishment of understory shrubs like aromatic sumac (*Rhus aromatica*) and native plum (*Prunus angustifolia*), follow the same procedures as in midstory establishment. Plant in irregularly-shaped mottes (clumps) of at least ½ acre in size containing a minimum of 100 seedlings, located separate and away from cottonwood (overstory) and deciduous tree (midstory) plantings to achieve a mosaic of different canopy heights at maturity. Spacing between seedlings should be at least 12 feet to allow for crown development at maturity, with expected heights ranging from ~6-8 feet. Establish a minimum of one (1) planting per 25 acres and a maximum of one (1) planting per 5 acres.
- To provide comprehensive environmental benefits at most sites, including stream bank stabilization, sediment filtration, aquatic habitat, wildlife habitat, and filtration for soluble nutrients, a *minimum* project development width of 100 yards on each side of the creek/stream channel is recommended. Widths up to 200 yards on either side of a stream course can be expected to yield higher habitat and aesthetic values.
- Riparian fencing is recommended at the stated widths, if not already in place, to increase manageability of these zones as distinctive grazing areas that require special treatment. Periodic grazing is a good management tool to maintain desirable native grasses, forbs, and legumes; however, it should be carried out in a manner that is not detrimental to woody species being established. Fencing enables control of specific seasons and duration of livestock grazing (see below). Specifications for 4-5 strand barbed wire fencing, as described in the Field Office Technical Guide at local offices of the USDA Natural Resources Conservation Service, is the recommended standard.
- Prior to planting season, some areas may need treatments like strip mowing or heavy grazing to remove rank vegetation. After establishment, individual poles/seedlings will need protection from grazing animals. Preferably, winter grazing of a short duration and moderate stocking rate should be employed for the first 5 years after planting (establishment phase) to minimize/avoid damage to woody plants during the growing season.
- Noxious invading species like salt cedar (*Tamarix spp.*) and Russian olive (*Elaeagnus angustifolia*) are detrimental to the long term health and habitat value of riparian zones. Aggressive control/eradication is recommended; however, effective

treatments can be expensive. For more information, contact Texas Agricultural Extension Service, the USDA Natural Resources Conservation Service, Texas Tech University, or Texas Parks & Wildlife Department.

### References

Chaney, E., Elmore, W., and W. Platts. 1993. Managing Change - Livestock Grazing on Western Riparian Areas. Produced for the Environmental Protection Agency by Northwest Resource Information Center, Inc. 31 pages.

Doskey, M., Schultz, D., and T. Isenhardt. 1997. Riparian Buffers for Agricultural Land. Agroforestry Notes - 3. National Agroforestry Center. USDA Forest Service, Rocky Mountain Station; USDA Natural Resources Conservation Service. 4 pages.

Doskey, M., Schultz, D., and T. Isenhardt. 1997. How to Design a Riparian Buffer for Agricultural Land. Agroforestry Notes - 4. National Agroforestry Center. USDA Forest Service, Rocky Mountain Station; USDA Natural Resources Conservation Service. 4 pages.

Doskey, M., Schultz, D., and T. Isenhardt. 1997. A Riparian Buffer Design for Crop Land. Agroforestry Notes - 5. National Agroforestry Center. USDA Forest Service, Rocky Mountain Station; USDA Natural Resources Conservation Service. 4 pages.

Fewin, R. 1992. Technical Guidelines for Texas State Stewardship Incentive Program - High Plains Windbreak and Wildlife Planting. Texas Forest Service. 6 pages.

Miller, G., Sherman, R., and J. Houston. 1986. Cottonwood Riparian Zones of Colorado. Colorado Division of Wildlife. 11 pages.

Miller, G., and J. Ray. 1996. Managing Riparian Habitat for Wildlife in Northwest Texas. Texas Parks & Wildlife Department, Wildlife Division. 2 pages.

Revegetating Southwest Riparian Zones. Cooperative Extension Service, New Mexico State University. Pamphlet developed jointly by Cooperative Extension Service @ NMSU, U. S. Fish & Wildlife Service, and the USDA Natural Resources Conservation Service. 8 pages.

Stinnett, D., Smith, R., and S. Conrady. 1987. Riparian Areas of Western Oklahoma - A Special Study of Their Status, Trends, and Values. U. S. Fish & Wildlife Service and Oklahoma Department of Wildlife Conservation, Game Division. 92 pages.

## APPENDIX P

# Wildlife Considerations in the Management of CRP Lands



Permanent vegetative cover afforded by the Conservation Reserve Program (CRP) is generally beneficial to wildlife in the Southern Great Plains. Voluntary retention of these lands in permanent cover will provide long term benefits to soil, water, wildlife, and wetland resources through increased infiltration of rainwater, reduced runoff, and improved soil fertility. To the extent that the 1996 Farm Act recognized filterstrips, grass waterways, riparian areas, field windbreaks, shelterbelts, shallow water areas, and acreage with an erodibility index of more than 15 as ineligible for “early out” contract provisions, a positive consideration for wildlife and wildlife habitat was provided. Likewise, a determination by the Secretary of Agriculture that acreage enrolled under the wetland criteria during the 8th and 9th signup periods and acreage on which a CRP useful life easement is filed will be ineligible for “early out”, as stated in the Interim Rule for CRP, dated August 27, 1996, was another positive consideration for wildlife and wetland habitat. Finally, the most significant consideration given to wildlife and wildlife habitat was elevation to *co-equal status with soil and water resources* in the language of the Act itself.

What are some key wildlife considerations for CRP landowners in the High Plains and Rolling Plains of Texas? As a rule, increasing plant species diversity greatly improves the wildlife habitat value of CRP, especially within *microhabitats*, at the farm and neighborhood level. In most cases, CRP grass monocultures cannot be expected to provide optimum wildlife habitat because they lack the required diversity to address limiting factors (food, cover, water, interspersion) of many groups of species endemic to ecological areas within the SGP (i.e. High Plains & Rolling Plains Ecological Areas in Texas). Also, the size, shape, and interspersion of these tracts in relation to other land use greatly influences their value as a component of habitat. For example, no less than several thousand acres of CRP comprised of buffalograss, blue grama, sideoats grama, and native forbs, located adjacent to native shortgrass rangeland and managed with a rotational grazing/burning system favoring a forb (food) component, would be required to significantly impact pronghorn antelope or certain grassland birds. On the other hand, 40, 80, and 160-acre parcels of diverse native grass/legume mixtures, strategically located at quarter-mile intervals in intensively-farmed (feed grain) areas, could be expected to greatly increase carrying capacity for ring-necked pheasants. In short, if habitat enhancement for species/groups of species is a (CRP) landowner objective, there are key factors to consider in a) retention and enhancement of existing tracts and b) establishment of new lands in the program. The following suggestions are based on life history and ecology of species found within rangeland and agricultural habitats in the Southern Great Plains.

Big Game (Mule Deer, White-tailed Deer, Pronghorn Antelope)



These animals benefit from planned grazing/burning systems on CRP lands because of improved vegetative composition and increased digestibility and palatability of plant material, especially native legumes and forbs. Deferment of strategically located grazing units will help increase productivity by providing fawning and escape cover to minimize losses to coyotes. The most intensive systems with higher stocking rates may tend to favor pronghorn antelope and “species of special concern” such as swift fox (*Vulpes velox*) on larger CRP tracts that were seeded to shortgrass and are surrounded by remnant (shortgrass) prairie. Maintenance of livestock water will satisfy the needs of these species. CRP areas located between brush tracts/canyonlands and agricultural crops will act as travel corridors and tend to promote range expansion of mule deer and white-tailed deer. Intensive grazing/burning systems augmented by interseeding of legumes/forbs (i.e Eldorado engelmann daisy, maximilian sunflower, Illinois bundleflower, and alfalfa) may help alleviate real/perceived crop damage on adjacent agricultural lands. Brush encroachment will favor white-tailed deer over mule deer where they occur sympatrically, and will eventually disfavor pronghorns, depending on plant density and reduction of visibility. Browse establishment (fourwing saltbush, aromatic sumac) for big game will also benefit upland game birds. Finally, retention of larger tracts *with management* where big game is present, often only in moderate densities in “plains” habitats, can be expected to positively impact this species group and other grassland birds and mammals by reducing habitat fragmentation.

Upland Game Birds (Bobwhite Quail, Scaled Quail, Ring-necked Pheasants, Lesser Prairie Chickens, and Rio Grande Wild Turkeys)

These species also benefit from rotational grazing/burning systems on CRP lands because of increased forb (food) production and insect (food) availability, improved brood range (bare ground shaded by vegetation of differing heights), and interspersions created by this type of management. Retention of smaller tracts associated with range or farmed areas and “fencerow” habitat will favor bobwhite quail and ring-necked pheasants, while larger tracts adjacent to rangeland can benefit bobwhite or scaled quail, provided that other essential habitat components are located nearby on adjacent lands. Generally, lack of woody cover is limiting to quail on CRP lands, and can be remedied by brush





establishment along fencerows, field borders, and in clumps or “mottes” when compatibly planned with grazing, burning, or haying operations. Less woody cover (~10-15%) generally favors scaled quail; conversely, increased woody canopy (~25-30%) promotes bobwhites, provided other management is included. Lesser prairie chickens and Rio Grande wild turkeys require greater diversity of woody cover, legumes, forbs, and native grasses on larger CRP tracts adjacent to occupied habitats.



Retention of larger tracts in occupied prairie chicken and wild turkey range, *with management*, can be expected to eventually benefit these species that have higher mobility and larger home ranges. Ring-necked pheasants will thrive in areas of diverse native grass/legume/forb tracts of 40-160 acres interspersed with playa wetlands, agricultural feed grains, fencerows, and roadsides because of the interspersion created to provide heavy winter cover, nesting cover, brood range, and food afforded

by retention of smaller CRP tracts. Even retention of *circle irrigation corners in CRP cover* at the farm level can provide excellent pheasant habitat in association with grain production. Haying can be compatible with upland “ground-nesting” bird production, provided a) it is delayed until *after the peak of nesting season* (generally July 15th), b) portions of fields are left undisturbed in strategic locations (i.e. adjacent to fencerows, crop fields, playa wetlands, brush, “no-mow” roadside areas), and c) fields are periodically managed with fire to prevent accumulation of excessive ground litter. A policy of periodic managed haying on CRP lands, rather than “emergency” haying, could be a positive consideration for wildlife in the SGP.

Grassland Birds (i.e. Song Sparrow, Field Sparrow, Dickcissel, Red-winged Blackbird, Grasshopper Sparrow)

CRP fields seeded to permanent vegetation provide superior nesting habitat for grassland birds compared to rowcrop fields. Long term studies conducted in the SGP have documented *21 times the number of grassland bird nests in CRP fields* compared to rowcrop fields, and *31 times the number of successful nests*. This is considered a true success of CRP by wildlifers, as many of these grassland bird species have been in decline. Species like the mountain plover, long-billed curlew, upland sandpiper, Swainson’s hawk, common nighthawk, lark bunting, yellow-headed blackbird, common yellowthroat, Cassin’s kingbird, Baird’s sparrow, and bobolink will all benefit from grazing/burning management systems on CRP tracts adjacent to shortgrass and mid-grass rangeland in the SGP. Notice that management



practices/considerations for this group are compatible with those for other species/groups affiliated with retention of larger CRP tracts and rangelands in the SGP.

*Waterfowl and Wetland Wildlife (Ducks, Geese, Cranes, Reptiles, Amphibians, Shorebirds)*

Retaining a 3:1 ratio (or at least 2:1) of CRP upland grass buffer to playa basin acreage would effectively protect any playa in the SGP, especially in intensively agricultural areas, to provide quality habitat for reptiles and amphibians, prevent further degradation/siltation of basins, and provide quality nesting cover for pheasants and ducks in many neighborhoods. Our region is a major waterfowl wintering area for ducks, geese, sandhill cranes, and American bald eagles. Additionally, we summer many neotropical migratory birds, including shorebirds, in and around wet playas, and our Ogallala Aquifer is recharged through the 25,390 playas located throughout the SGP. Retention of permanent vegetative buffers in CRP



around playas, protection with fencing, management of buffers with planned grazing/burning, and interseeding of legumes is *highly recommended* for the benefit of waterfowl and wetland habitats. These practices are totally compatible with the goals of the ***Playa Lakes Joint Venture***, our region's contribution to the *North American Waterfowl Management Plan*, and to strategies set forth by farmers, ranchers, and sportsmen, including CRP contract holders, serving on the Panhandle Regional Advisory Group currently helping to craft the *State Wetlands Plan*, a voluntary initiative being guided by Texas Parks & Wildlife Department.

For more detail on wildlife considerations in the management of CRP lands, please see the accompanying publication entitled "***Wildlife Habitat Management on Former CRP Lands***", consult with your NRCS Field Office for current rules as they evolve, and seek advise from your local wildlife biologist with the Texas Parks & Wildlife Department @ 806/655-3782 or -3975; FAX 806/655-4045 (Panhandle District). Free, confidential, non-binding assistance is available to landowners through the Department's ***Private Lands & Public Hunting Program***.

## APPENDIX Q

# NATIVE BRUSH ESTABLISHMENT ON RANGELAND FOR WILDLIFE

A strategy to improve rangeland for wildlife in selected locations throughout the High Plains and Rolling Plains is *native brush establishment* through transplanting *fourwing saltbush* (*Atriplex canescens*). This native shrub is excellent deer/pronghorn browse, quail cover, attractive to songbirds, very drought hardy, reserve cattle feed (14% protein), and adaptable to a wide range of soil types. A key feature is that during the spring, it is not so palatable that cattle will choose it ahead of grasses when they are growing luxuriantly; rather, cattle will take it later in the growing season. So you benefit wildlife, livestock, and aesthetics. Although it is compatible with grazing systems after establishment, transplanted seedlings should ideally be protected from grazing for at least the first growing season. Dr. Darrell Ueckert, noted saltbush expert with the Texas Agricultural Extension Service at San Angelo (325/653-4576), advises the following establishment technique:

- Transplant locally-grown and adapted seedlings from Texas Forest Service in Lubbock (806/746-5801), also available through local Soil & Water Conservation Districts in (individual "bullets").
- Seedlings should be transplanted with a 3-point hitch forestry transplanter (Texas Parks & Wildlife Department or Texas Forest Service) into a freshly-ripped furrow, either in mottes or sculpted to natural contours of the landscape. Fifteen (15) feet minimum spacing within or between rows is recommended for our semi-arid climate. Size and distribution of plots should be determined based upon landowner goals, compatibility with grazing systems, and cover needs of targeted species (mule deer - 15 to 40% canopy cover; bobwhite quail - 25% canopy; scaled quail - 10 to 15% canopy; pronghorns - 5 to 10%). Landowners wishing to consider the needs of neotropical (summer) migratory birds and "species of special concern" like the black-tailed prairie dog or swift fox that depend on shortgrass prairie may wish to consult with a local Department biologist for advise prior to employing this technique.
- For optimal survival, transplanting should be done after our "rainy season" has begun, usually mid-May, so as to *minimize* the need for supplemental watering during the first year. Ideally, seedlings should be watered with *2-3 gallons per plant* as part of the transplanting operation. Simply put, "if it doesn't rain, don't plant", as this strategy does not utilize the high-successful weed barrier fabric mulch employed by regional biologists in shelterbelt installation (contact the *Wildlife Division Field Office* in Canyon @ 806/655-3782 to arrange a field tour with one of our cooperators).
- Consider establishing initial mottes or "contours" in conjunction with riparian zones, draws, and gentle slopes (<3%) to take advantage of deeper soil types and existing/planned fencing (see *Riparian Management*). The growth form of saltbush should be larger on bottom sites and slightly smaller on gentle slopes or

uplands (average 3-4 feet height).

*Free technical assistance* is available to landowners wishing to enhance wildlife habitat and populations through the Department's ***Private Lands Enhancement Program***. Contact your local biologist or the Wildlife Division at 806/655-3782 for more information.

## ***Tentative Recommendations for Establishment of Woody Quail Cover and Deer Browse Plots on farm or ranch lands in the High Plains and Rolling Plains\****

The following procedures are recommended for establishment of native, drought-hardy shrubs like aromatic sumac (*Rhus aromatica*), native plum (*Prunus angustifolia*), and four-wing saltbush (*Atriplex canescens*) as overhead protective cover for quail and deer browse plots:

- Plant in irregularly-shaped mottes (clumps) of at least ½ acre in size containing a minimum of 100 seedlings, using a species mix as mentioned above.
- Spacing between seedlings should be at least 12 feet to allow for crown development at maturity, with expected canopy heights ranging from ~6-8 feet, which will vary with shrub species, soil type, and topography.
- Establish a minimum of one (1) planting per 25 acres and a maximum of one (1) planting per 5 acres. Plant during March-April using a tractor-mounted post hole digger, hand crew, fabric squares (3-feet or 4-feet) and 2-3 gallons of water per seedling at planting time with a water tank (clean, preferably one not used for chemicals).
- Seedlings should be protected from browsing animals (deer and rabbits) with commercial tree protector tubes installed at planting time.
- Where livestock grazing is present, shrub mottes (clumps) should be fenced with a 4-strand barbed-wire fence (recommend NRCS specifications) or a 2-strand high-tensile electric fence to prevent trampling and promote longevity of the planting for cover. A 20-foot buffer around the outside edge of shrubs is recommended to enhance the cover value of such plantings for wildlife.

\*these guidelines may be customized for cropland, native range, or lands enrolled in CRP; woody plant growth form and development will vary according to location, topography, annual precipitation, and soil type

\*\*\*\*\*

Prepared by **Gene T. Miller**, Technical Guidance Biologist, TPWD @ 806/655-3782, on 7/26/00 and are offered only as **generic** recommendations which may subject to revision upon inspection of a particular property and according to goals and objectives established by the landowner.

## APPENDIX R

# Establishing Shelterbelts for Wildlife

Landowners can increase wildlife habitat value in carefully-selected areas within the High Plains and Rolling Plains by creating shelterbelts, living snow fences, and habitat corridors. Care should be taken to install plantings in association with intensively agricultural areas and/or in conjunction with CRP lands, rather than establishing new, large plantings in areas of extensive shortgrass prairie habitat, so as not to actually degrade habitat quality for other endemic species. Texas Parks & Wildlife Department (TPWD) biologists, in cooperation with Texas Forest Service, have successfully used state-of-the-art techniques, locally-grown and adapted seedlings, and enlisted the support of private landowners in a cooperative effort with conservation organizations and governmental agencies to establish demonstrations of this technique. Habitat improvement for ring-necked pheasants, scaled quail, and bobwhite quail is often the key objective. Texas Parks & Wildlife Department no longer recommends inclusion of evergreen species in shelterbelt plantings.

## SPECIFICATIONS

### Design Recommendations

- Minimum shelterbelt length is 1/4 mile (1320' tree rows) plus 40' borders on each end for a total of 1400' from one fenced end to another.
- Minimum width is 150' (from fence to fence), consisting of a 4-row planting with a native shrub or tree row 20' from the fence, followed by another native shrub or tree row at a 20' interval, followed by a deciduous tree row at a 40' interval, followed by a shrub row at a 40' interval, then a 30' border to the fence.
- 5-row planting width is 170' (fence-20'-native shrub row-20'-native shrub row-40'-deciduous tree row-40'-deciduous tree row-30'-shrub row-20'-fence).
- 6-row planting width is 190' (fence-20'-native shrub row-20'-native shrub row-40'-deciduous tree row-40'-deciduous tree row-30'-shrub row-20'-shrub row-20'-fence).

Customized designs are possible depending on soil type and topography with on-site recommendation by TPWD, Texas Forest Service, or NRCS personnel. Sculpting of multirow plantings along the contour of the land is highly recommended for creation of more edge effect for upland game birds and for aesthetics.

### Species

- Deciduous tree species recommended for planting are Osage orange or Bois d'arc (Maclura pomifera), Honeylocust (Gleditsia triacanthos), Chittamwood or bumelia (Bumelia lanuginosa), and Mulberry\* (Morus rubra).
- Shrub species recommended for planting are Fourwing saltbush (Atriplex canescens), Skunkbush sumac (Rhus aromatica), American Plum (Prunus americana), and Sand (or native) plum\* (Prunus angustifolia).

\*To be used only from Amarillo south on sandy soils

## Spacing

- Within rows, shrubs should be spaced at 15' intervals. Deciduous trees should be spaced at 30-45' intervals.

## Fencing

- Fencing is highly recommended on all shelterbelts with a 4-strand barbed wire fence (NRCS specs). Standard clearance on all plantings is 20' minimum from the sides of outside tree rows, with a 40' border on each end. **Fencing is to be done prior to shelterbelt installation.**
- 24" x 1" poultry netting should be placed around exterior of fence at bottom with 4" draped on the ground (critical for rodent control).

## Placement

- When shelterbelt is installed on the north side of an east-west road, site should be planned so as to have the first row no closer than 200' from the driving edge of the road. (Functionally, this planting may serve as a living snow fence).
- In all cases, shelterbelts should be at least 50' away from road intersections for traffic safety.

## Site Preparation

- On grassland (range or CRP land), an area slightly larger than the area to be fenced should be mowed clean if needed to remove rank vegetation in order to facilitate fencing and planting operation.
- On grassland (range or CRP land), where land is classified as highly erodible (HEL), sod must not be removed from the entire site.
- For site prep of individual tree/shrub row to be planted, a 10' wide strip (seedbed), centered on the "planting line", should be disced, plowed, and/or roto-tilled in the fall or early winter, so as to remove all grass. The goal is to achieve a high-quality seedbed for mechanical tree planting and fabric laying. **This is critical to establishment and success of the planting.**
- **On clay and clay loam sites**, at least the "planting line" on each 10' strip should be chiseled to a depth of 12" or greater during the fall prior to planting. Chiseling greatly facilitates use of the tree planter. **This is critical to establishment and success of the planting.**
- Shelterbelt planting sites on cropland classified as highly erodible (HEL) should be fall sown to a temporary cover crop of wheat or other suitable annual. The cover crop should be sown at least 60' to the windward side(s) for soil stabilization. During the spring, a

permanent native grass-legume cover should be sown between tree rows and for a distance of 60' to the windward side(s).

- On non-erodible cropland, site should remain fallow during the winter months with crop residue in place, except for timely site prep of tree row "seedbeds".

## Planting Stock

### Source

- Seedling source should be from the same region as the planting area. Materials from Texas Forest Service (West Texas Nursery) in Idalou, distributed through local Soil & Water Conservation Districts, are recommended. **The use of locally-grown and adapted planting materials is critical to the establishment and success of the planting.**

### Type of Stock

- Deciduous seedlings (1-0 and 2-0) may be bare-root stock. Minimum stem caliper at the root collar is 3/16" for 1-0 seedlings and 1/2" for 2-0 seedlings. Minimum height is 12" for 1-0 stock and 15 inches for 2-0 stock.

## Planting Method

- Landowner should plan to use 2 tractors (50+ hp, Cat II, 3-pt hitch) **with operators** on planting day, **plus a crew of 6 persons** (minimum) to install planting. If a contract installation crew is available, landowner may opt to use the service with possible cost share assistance (contact Texas Forest Service @ 806/746-5801).
- A tractor-drawn tree planter (Category II, 3-point hitch) is recommended for installation of said plantings. Landowners may rent a tree planter from Texas Forest Service (806/746-5801) in Lubbock.
- Weed barrier fabric (6' width) should be installed by machine (Category II, 3-point hitch) immediately after trees are planted. Texas Forest Service's fabric-laying machine can be available for use by landowners by prior arrangement. Some local Quail Unlimited chapters are beginning to obtain such equipment for use with landowners on cooperative projects. Seedlings will be pulled up through a slit cut in the fabric.
- **On clay sites**, 6" companion pins should be placed offset from the row at 1' intervals on each side of seedlings and midway between each seedling in the row center.
- **On sandy sites**, one shovel of soil should be placed in the row center between each seedling in lieu of companion pins.
- Lastly, individual seedlings should be hand-watered **at planting time** with nurse tank, provided by the landowner.

## Maintenance and Care

### Supplemental Watering



- Supplemental watering **at least twice** during the growing season (depending on moisture conditions) is recommended for the first 3 years. The rates are adjustable because of soil type. Sufficient water should be applied to thoroughly soak the soil below the root zone. (The weed barrier fabric will accept water at the rate of about 9 gallons per square foot per minute).

#### Vegetation Shading

- On east-west plantings where vegetation height immediately adjacent to the tree row exceeds 2', a 6' wide strip should be shreaded **on the south side** of the row to prevent shading. Likewise, on north-south plantings, the **west side of the tree row** should be shreaded (6'). **This is important for the the first 2 years.**

#### Protection

- All shelterbelt plantings should be protected from any possible livestock grazing/trampling with fencing as previously described. For technical assistance on prairie dog, gopher, or rabbit control measures, contact Texas Parks & Wildlife Department or Texas Wildlife Damage Management Service (in Canyon, 806/651-2880).
- 24" x 1" poultry netting should be installed on the outside of fence with 4" draped (L-shape) and buried at the bottom for rodent control.
- Firebreaks around tree plantings are recommended. They can be established be removing all flammable materials through discing or scraping. The firebreak width should be 2 1/2 times the height of the surrounding vegetation but not less than 4' wide. Firebreaks offer the opportunity for annual wildlife food plots. **Firebreaks on CRP sites should be shreaded annually as needed.**
- Trees should inspected periodically to detect insect or disease problems. Contact the Texas Forest Service for specific diagnosis and recommended control measures.

#### Tree Replacement

- Loss of seedlings less than 3 years from original planting date should be replaced. Replacement of older trees is recommended if the resultant gap in the shelterbelt is larger than the average crown spread of adjacent trees. Replanting should be done with the same species. Refer to various appendices contained herein for a detailed understanding of woody cover requirements for wildlife species occurring throughout the High Plains and Rolling Plains. TPWD biologists in the region are available through the *Private Lands & Public Hunting Program* to show landowners firsthand the validity of this technique for habitat enhancement in our semi-arid environment without drip irrigation. Overall survival on plantings installed since 1993 has been greater than 95% with impressive growth rates.

## APPENDIX S

### General Comments Concerning Federally Listed Endangered Species

*Awareness* is the key to owning and managing lands on which federally listed endangered species occur. The following is a simple key for *High Plains and Rolling Plains* landowners to use, and detailed (confidential) consultation with a Department wildlife biologist is advised prior to implementation of habitat manipulation practices.

- o Gray wolf (*Canus lupus*) - This species historically occurred throughout the High Plains of Texas and is now thought to be extirpated.
- o Black-footed ferret (*Mustela nigripes*) - This species is thought to be extinct in the High Plains of Texas; however, it did occur in the black-tailed prairie dog-burrowing owl-prairie rattlesnake complex that exists today in prairie dog towns on shortgrass prairie sites.
- o American peregrine falcon (*Falco peregrinus anatum*) - This is a neotropical (summer) migratory species infrequently observed gliding over prairies and croplands.

*To the best of our knowledge, there are no habitat manipulation practices recommended herein that would adversely impact these species. For a current update of listings for any county in the High Plains or Rolling Plains, contact TPWD in Austin @ 1-800-792-1112.*



## APPENDIX T

# Nongame Wildlife Management Recommendations

Following is a list and brief description of management practices that are beneficial to nongame species of wildlife. It should be noted that many of the practices are also beneficial to and recommended for game species (eg. deer, dove, turkey quail, etc.). Conversely, most management practices directed at managing game species will also be beneficial to many species of nongame wildlife.

### HABITAT CONTROL

**Prairie/grassland restoration** - Establishing a mixture of native grasses and forbs on disturbed range or farm land to provide habitat for wildlife diversity. Use the TPWD wildscape plant list.

**Forest/woodland restoration** - Establishing native trees and shrubs where appropriate to restore native habitats for wildlife diversity. Use the TPWD wildscape plant list.

**Shrubland restoration** - Establishing native shrubs or small trees where appropriate to restore native habitats for wildlife diversity. Use TPWD the wildscape plant list.

**Wetland restoration** - Establishing water flows and native vegetation in altered coastal and inland wetlands to provide wildlife habitat.

**Riparian area management** - Provide alternate livestock feeding and watering sites, exclude pastures with riparian areas from livestock grazing or fence out livestock. Defer grazing in riparian areas during April - October.

**Prescribed burning** - The use of fire to restore, enhance or maintain native habitats for wildlife diversity.

**Mowing** - Used to manage invading woody plants and maintain desirable herbaceous vegetation for wildlife food and cover. Mow before or after nesting season to avoid grassland nesting birds (most nesting occurs generally April-June).

**Exotic or "weedy" plant control** - Use of fire, selective herbicides, and mechanical methods to control invasive plants in important habitat types to maintain or restore wildlife populations.

**Conversion of exotic vegetation** - Removal and replacement of exotic vegetation with native plants for wildlife habitat.

**Restore and maintain native prairie/grassland** - Prescribed burns should be conducted according to TPWD, USDA Natural Resource Conservation Service, Texas Agricultural Extension Service and Texas Natural Resource Conservation Commission

protocols in coordination with local Fire Department. Most burns are conducted during December-March. Late winter-early spring burns will not impact cool season forbs as much as mid-winter burns. Summer burns are more risky, but could be more effective at woody plant control. If mechanical brush control is used leave brush piles for small mammals. Reseed areas with native grass/forb mixtures as necessary.

**Enhance mid-succession brush habitat** - Promote brush regeneration with prescribed fire and/or mechanical methods that remove the top-growth of woody plants but encourage root sprouting. Use proper grazing management.

**Protect karst, caves and other underground resources** - Construct appropriate cave gates or other features to minimize human disturbance to roosting bats. Insure quality underground water resources through proper disposal of toxicants and runoff management. Maintain unobstructed cave entrance for easy access by bats.

## **EROSION CONTROL**

**Riparian area management** - Provide alternate livestock feeding and watering sites, exclude pastures with riparian areas from livestock grazing or fence out livestock. Defer grazing in riparian areas during April - October. Control erosion using water structures and native plants.

**Prairie/grassland restoration** - Establishing a mixture of native grasses and forbs on disturbed range or farm land to provide habitat for wildlife diversity. Use the TPWD wildscape plant list.

**Forest/woodland restoration** - Establishing native trees and shrubs where appropriate to restore native habitats for wildlife diversity. Use the TPWD wildscape plant list.

**Trails and signs** - Create walkways or paths to manage human impact and reduce erosion in sensitive areas.

## **PREDATOR CONTROL**

**Avian predator and parasite control** - Reduce the impact of selected avian predators (grackles, ravens, crows) and brown-headed cowbirds on nesting birds through shooting and trapping, grazing management, and maintenance of large blocks of wildlife habitat.

**Carnivore-furbearer control** - Reduce the impact of coyotes, raccoons and other carnivores on colonial nesting birds.

## **PROVIDING SUPPLEMENTAL WATER**

**Wetland restoration** - Establishing moist soil management in playa wetlands (High Plains) and managing wet meadow/perched water table/riparian habitats (Rolling

Plains).

**Well/trough/pond with overflows** - Establish additional shallow water supplies through construction of ground-level wildlife ponds, or adding overflow systems on existing wells and troughs. Protect these areas from livestock use.

### **PROVIDING SUPPLEMENTAL FOOD**

**Prairie/grassland restoration** - Establishing a mixture of native grasses and forbs on disturbed range or farm land to provide habitat for wildlife diversity. Use the TPWD wildscape plant list.

**Woody restoration** - Establishing native trees and shrubs where appropriate to restore native habitats for wildlife diversity. Use the TPWD wildscape plant list.

**Butterfly and hummingbird gardens** - Establish native wildflowers, trees, shrubs, vines, or cultivated flowers as food sources for butterflies and hummingbirds. Use the TPWD wildscape plant list.

**Feeding stations** - Set up liquid, seed and free-choice feeding stations for resident and migratory birds. Especially critical during migration and winter months when natural food sources are scarce.

**Reduction of broadcast insecticides** - Increases the amount of insects available as a wildlife food source for birds, reptiles and amphibians.

**Conversion of exotic vegetation** - Removal and replacement of exotic vegetation with native plants for wildlife habitat.

### **PROVIDING SUPPLEMENTAL SHELTER**

**Brush piles/rock piles** - Leaving or stacking cleared brush and rock to create denning and escape cover for birds, small mammals, reptiles and amphibians.

**Thickets of native brush** - Create or maintain thickets of native shrubs/trees for refuge.

**Prairie/grassland restoration** - Establishing a mixture of native grasses and forbs on disturbed range or farm land to provide habitat for wildlife diversity. Use the TPWD wildscape plant list.

**Snag maintenance and creation** - Protect snags and deadfall for cavity dwelling species. Create snags using selective herbicides or girdling undesirable woody plants.

**Nest boxes and perching platforms/poles** - Provide nest structures for songbirds, owls, small mammals, bats, raptors, herons, and other nongame species.

## **CENSUS (Surveys)**

**Time area counts** - The number of individual species seen or heard during a fixed time frame per unit area (eg. point counts for birds, squirrels).

**Drift fences/pit fall traps** - A system of flashing or similar material arranged on the ground to funnel small wildlife species into buried buckets or other pitfall trap. (used primarily for reptiles and amphibians).

**Small mammal traps** - Small live traps arranged along a trapline to sample small mammals.

**Other or Indicator Species:** Bobwhite quail, dove, and wild turkey may be desired game species to have in the area, which may be expressed in the overall objective. The land management techniques that have been recommended primarily for the deer population can benefit these game birds and many other wildlife species also. These are: prescribed burning, disking, cattle rotation or exclusion from woods and certain native grass areas during certain periods, and supplemental food plots. See Appendix G for more information on quail and Appendix I for wild turkey.

**Nest/Roost boxes for Cavity Nesters/Roosters:** Where suitable nest cavities are in short supply due to lack of dead timber snags that provide cavities or natural timber hollows, artificial nest/roost boxes can be erected to help alleviate these shortages for particular species. Some of the birds and mammals that can benefit from these structures are: bluebirds, chickadees, titmice, prothonotary warbler, wrens, woodpeckers, screech owls, kestrels, wood ducks, black-bellied whistling ducks, squirrels, and bats. The TPWD Nongame and Urban Program can furnish additional information regarding number, specifications, placement, and maintenance of these structures for specific species.

**Neotropical Migratory Birds:** These are birds that breed in the United States and Canada, and migrate to the Neotropical regions of Mexico, Central and South America, and the Caribbean during the nonbreeding season. As mentioned in the General Habitat Management section at the beginning of this example plan, loss and fragmentation of woodland and native grassland habitat has reduced populations of many neotropical populations. Neotropicals include the following groups of birds: kites, hawks, falcons, owls, cuckoos, nightjars, hummingbirds, flycatchers, swallows, thrushes, vireos, warblers, tanagers, grosbeaks, buntings, sparrows, orioles, and blackbirds. For more information regarding neotropical status, surveys, and possible management strategies, contact the Partners in Flight Program Coordinator at TPWD Headquarters in Austin.

**Waterfowl/Wading Birds:** To improve the habitat for dabbling ducks and wading birds, construction of 3 - 4 foot high levees with a drop-board water control structure in suitable low areas could back up and hold water during the fall, winter, spring, summer months, depending on water management strategy. This could provide shallow (6 to 24 inches) water feeding areas for migrant ducks, wading birds, and spring-nesting wood

ducks. Exclude livestock from this area with installation of an electric or barbed wire fence around the perimeter, at least 50 yards away from the maximum flooded area. Contact the local Natural Resources Conservation Service or TPWD waterfowl biologist for assistance in location and construction of the levee.

Installation of wood duck nest boxes in and around the edge of shallow water areas can increase nesting sites for wood ducks that are normally present in the summer, but lack suitable nesting sites due to lack of natural cavities in older, damaged trees or lack of these types of trees. One nest box (not within view of other nest boxes) per acre of brood-rearing wetland habitat is usually sufficient. These should be erected on 10 foot metal or treated wooden posts in or at the edge of wetlands.

**Feral Hogs** should be controlled by shooting and live trapping whenever possible. Most success at this usually occurs during the winter when feral hogs are having to travel more to find food. Besides rooting up pastures, feral hogs compete directly with deer, turkey and most other wildlife species that rely heavily on acorns and other hard and soft mast for winter food. Deer also tend to avoid areas when feral hogs are present.

**Other Comments:** The development of a Landowner Wildlife Management Association with adjacent and neighboring landowners will greatly enhance any management that you apply to your ranch, and is strongly encouraged. TPWD and TCE personnel are available to assist in this endeavor.

APPENDIX U

# Wildlife Watering Facilities



By  
**Jerry Turrentine, NRCS Biologist**  
USDA – Natural Resources Conservation Service



## WILDLIFE WATERING FACILITIES DESIGNS AND DRAWINGS

Designs for wildlife watering facilities can be simple or very complex. A simple facility works well in many situations by more complex facilities are needed in some situations. Each situation needs to be evaluated and the proper facility recommended to the landuser. To assist in making recommendations and designing these facilities and to supplement the standard and specifications, this technical note outlines specific criteria for a number of facilities.

### GENERAL GUIDELINES

1. Where livestock or larger wildlife species are present, the facilities should be fenced to provide proper protection. One example is shown in drawing number 16.
2. Plastic and PVC materials can be damaged by rodents and ultraviolet light. As little as possible of this material should be left accessible to rodents or sunlight.
3. In areas with hard winter freezes, some facilities can be damaged by hard freezes. Provisions should be made to drain or shut off water supply during these periods.
4. Proper maintenance of equipment will ensure adequate wildlife water and increase life of facilities. As with all equipment, facilities should be checked on a regular basis.
5. Algae growth can be a problem in many facilities. The less sunlight, the less algae growth problems will be encountered. As much as possible, the facility should be shaded. If algae growth becomes too bad, the facility may have to be drained and cleaned.

### NON COST SHARE FACILITIES

#### A. PVC (over other flexible type) Pipe Facility (Drawing #1)

1. Materials:

- 7 feet of 2 inch or larger PVC pipe
- 1 end plug to fit PVC pipe
- 1 sink trap to fit PVC pipe
- 1 six foot steel T post
- 2 four inch hose clamps.

2. Construction and Installation:

Cut off 1 inch of the open end of sink trap. Glue end plug and sink trap to PVC pipe. To fill, turn upside down and fill through sink trap. After filling, use hose clamps to fasten PVC pipe to T post. If larger PVC pipe is used, it can be necked down to 2 inch sink trap. A 3 inch PVC will hold 1 gallon, and a 4 inch will hold 4 gallons.

#### B. Drum with facet or Float (Drawing #2 and #3)

1. Materials:

- 1 drum (can use metal or plastic).
- 1 facet or float valve
- 1 stand (metal or wood)
- 18 inches of ¼ inch hose
- 1 metal or concrete trough (Should be at least 6" x 6" x 4" deep)

2. Construction and Installation:

Stand should be constructed so as to hold weight of filled drum. Stand should be leveled when installed. Insure that drum did not contain toxic material or is rusted wither inside or outside. If float valve is used, insure that trough is firmly installed and leveled. Most drums hold about 50 gallons.

#### **B. Small Game Guzzler (Drawing #4)**

1. Materials:

3 sheets corrugated galvanized metal (at least 10 feet long)  
8 feet minimum of 6 inch PVC (over other flexible) pipe  
2 six inch PVC caps or end plugs  
11 feet of 4 inch post  
11 feet of 2x4 inch lumber  
30 one inch sheet metal screws  
30 sixteen penny nails

2. Construction and Installation:

Three posts should be cut 2.5 feet in length and 3 posts cut 1.5 feet in length. Set post level in ground at 1 foot depth. The front post should be 6 inches lower than back post. Nail a 2x4 to top of back post and one to top of front post. Attach sheet metal together, making sure it is square, and attach to 2x4's. Cut a slot 1 inch wide, the same length as width of assembled sheet metal, out of PVC. Make sure the slot is centered in PVC. Six inches from each end of PVC, cut a 6 inch by 3 inch wide slot on the opposite side of the long slot. Install end plugs or caps.

Dig out soil at lower end of sheet metal. Install and level PVC in dug out area with sheet metal inserted into 1 inch slot. Metal should extend into PVC at least 2 inches. Put enough soil around PVC to ensure that it is stable.

A 0.3 inch rain will fill the PVC, and PVC will hold 12.5 gallons.

#### **C. Windmill Supply Pie Dripper (Drawing #6)**

1. Materials:

3 feet of metal or PVC (over other flexible) pipe (should be ½ inch larger in diameter than water supply pipe)  
1 cloth or sponge bushing  
1 metal or concrete trough

2. Construction and Installation:

Slip metal or PVC pipe sleeve over water supply line. Wedge cloth or sponge bushing between the two pipes. Make sure water discharge will enter trough. The rate of water flow can be regulated by sliding sleeve up or down water supply pipe. Area of pipe and trough should be protected from livestock.

#### **D. Plastic Container (Drawing #13)**

1. Materials:

1 plastic or metal container (smallest size should be 5 gallons)

- 1 commercial spring operated chicken watering bowl
- 2 cement blocks or 6 bricks

2. Construction and Installation:

Install watering bowl to bottom of watering container. Set facility on blocks or bricks at a height that allows target wildlife species to utilize. Make sure facility is level.

## COST SHAREABLE FACILITIES

### A. In Ground Bowl Trough (Drawings #7, #8, #12, #14, and #16)

#### Storage Trough:

1. Trough Material: Concrete will be at least 5 sack cement mix. Concrete will be reinforced using 6" x 6" welded wire. Metal trough using pipe should meet criteria for pipe material listed below under heading "Pipe Material". If the trough is constructed of sheet metal it should be new and at least 12 gauge.
2. Trough Size: Concrete troughs for upland game birds should be at least 1 foot by 4 inches deep at the center (will hold 2 gallons). Concrete troughs for big game should be at least 1.5 foot by 6 inches deep at the center (will hold 6.5 gallons). Metal troughs for upland game birds should be at least 4 inch pipe, 3 feet long (will hold 2 gallons). Metal troughs for big game should be at least 6 inch pipe, 5 feet long (will hold 6.5 gallons).

#### Pipe and Pipeline:

1. Pipe Material: May use existing pipeline or new pipeline and either used shall be at least ¾ inch diameter and can be galvanized steel, aluminum or plastic complying with the following specifications:

Steel A-120 (galvanized)	ABS D-2282 (SDR-PR)
ABS D-1527 (sch. 40 or 80)	PE D-2104 (Sch. 40)
PE D-2239 (SIRD-PR)	PE D-2737 (PE Tubing-PR)
PE D-3035 (SRD-PR)	PVC D-1785 (Sch. 40, 80, or 120)
PVC D-2241 (SDR-PR)	PVC D-2740 (PVC Tubing – PR)
PE D-2247 (Sch. 40 or 80)	

#### Additional Requirements:

If a facet is used it shall be new and shall meet or exceed pipe used. After water volume is set the handle should be removed. If a float is used it should be new and of good quality. If a drip emitter is used it should have the capability of being cleaned out. Metal pipe trough will be anchored by use of concrete or metal legs buried in the ground at least 18 inches.

### B. Big Game Guzzler ( Drawing #9)

For specifications to big game guzzler, see supplement to standard and specifications for wildlife watering facility.

**C. Inverted Umbrella Guzzler (Drawing #10)**

This facility is commercially produced. It is available in 2000 to 5000 gallon sizes. The basin diameters are 16 to 32 feet. It takes 8 inches annual rainfall for 2000 to 3000 gallon size and 10 inches for the 5000 gallon size. No float needed if trough and tank set at same level.

**D. Flying Saucer Guzzler (Drawing #11)**

This facility is commercially produced. It is available in 200 to 2100 gallon sizes. It takes 6 inches annual rainfall for 200 gallon size, 8 inches for 1000 gallon size and 17 inches for 2100 gallon size. No float needed if trough and tank set at same level.

**E. Ranch Specialties Wildlife Waterer (Drawing #15)**

This facility is commercially produced. It holds 9.5 gallons of water. The float is built into the facility. The facility is 42 inches by 42 inches and 7.5 inches deep with a 3 foot diameter bowl. To be eligible for cost share, the facility must be connected to a permanent water source.

# WILDLIFE WATERING FACILITIES

SCALE: 3/8" = 1'

SCALE: 3/4" = 1'

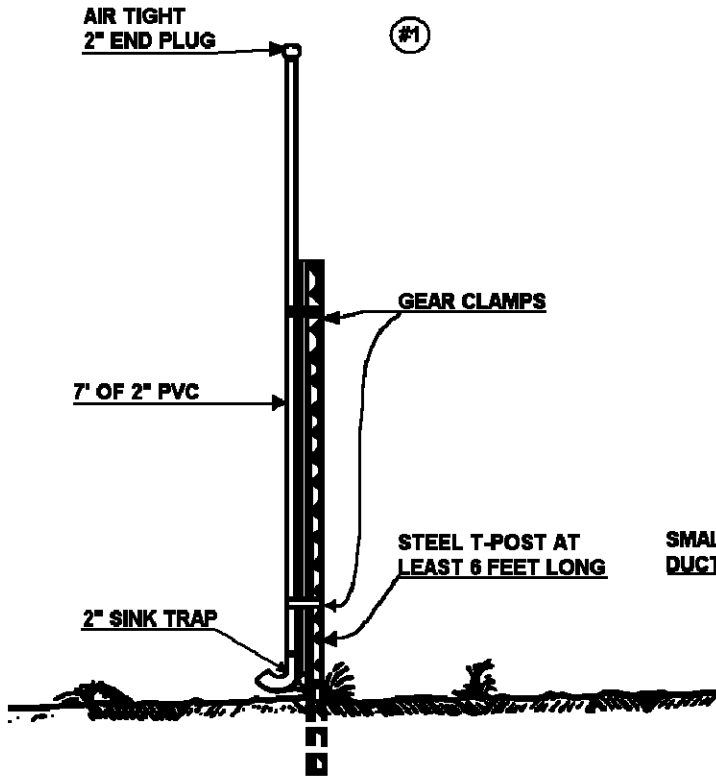

SCALE: 3/4" = 1'

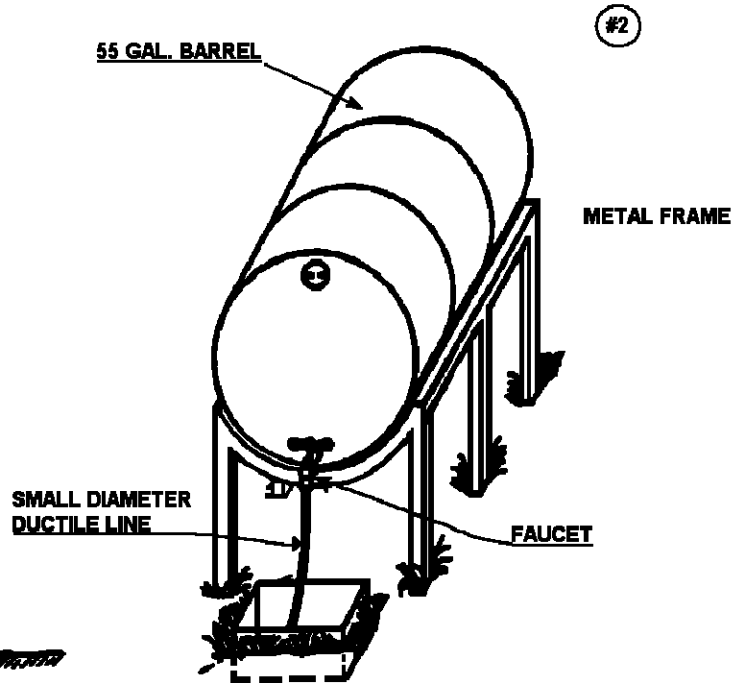

#4

SCALE: 1/4" = 1'

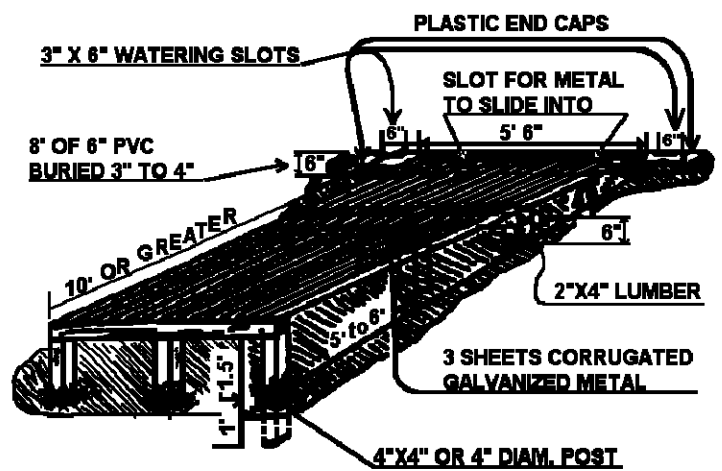
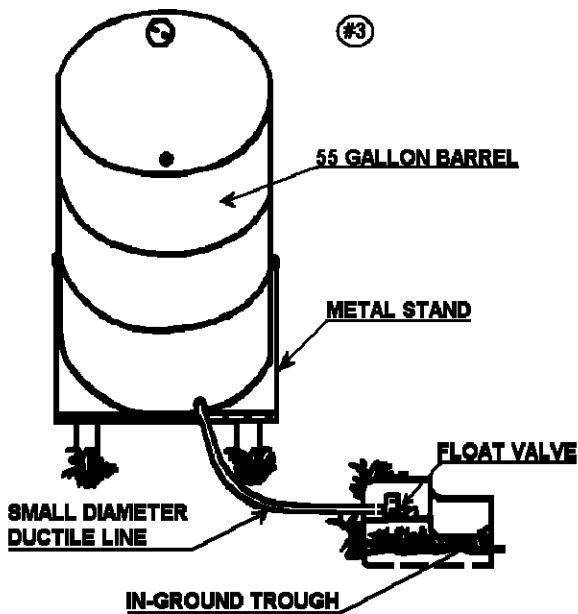

DRAWINGS BY TODD A. MAREK  
SEPT. 1991

## WILDLIFE WATERING FACILITIES

### 3 METHODS OF ANCHORING ON-THE-GROUND CATCHMENTS

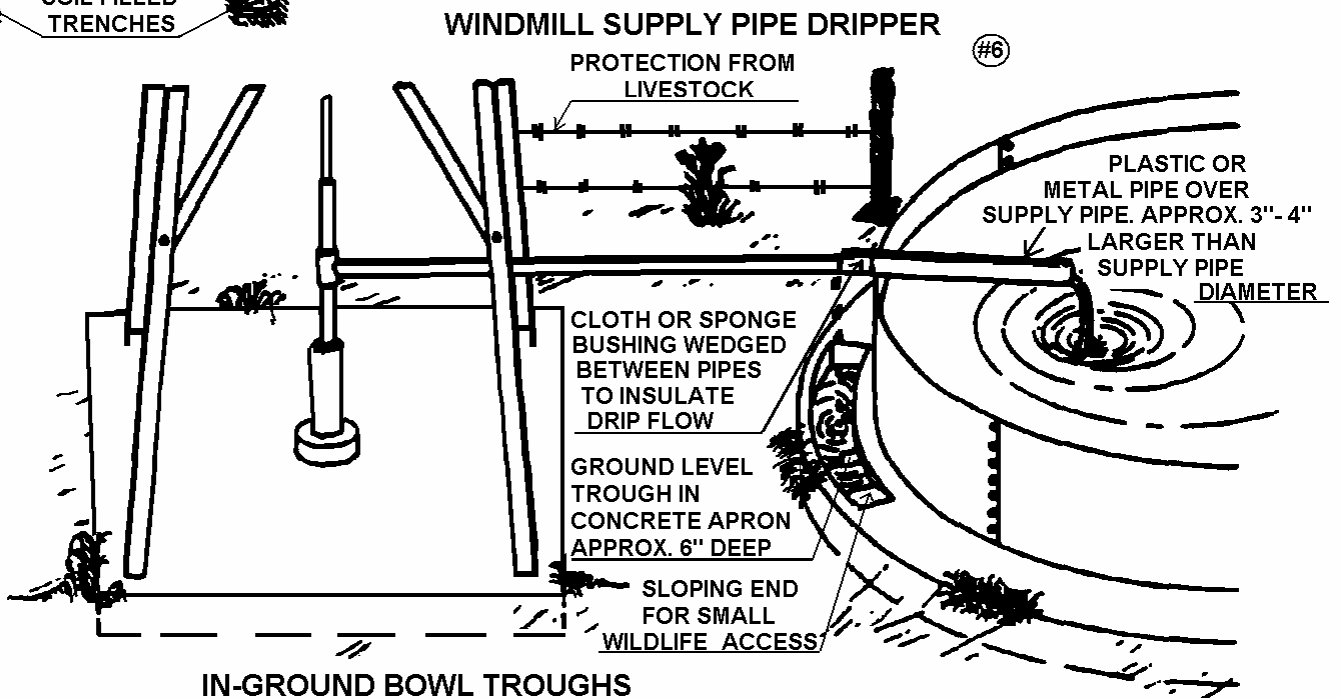
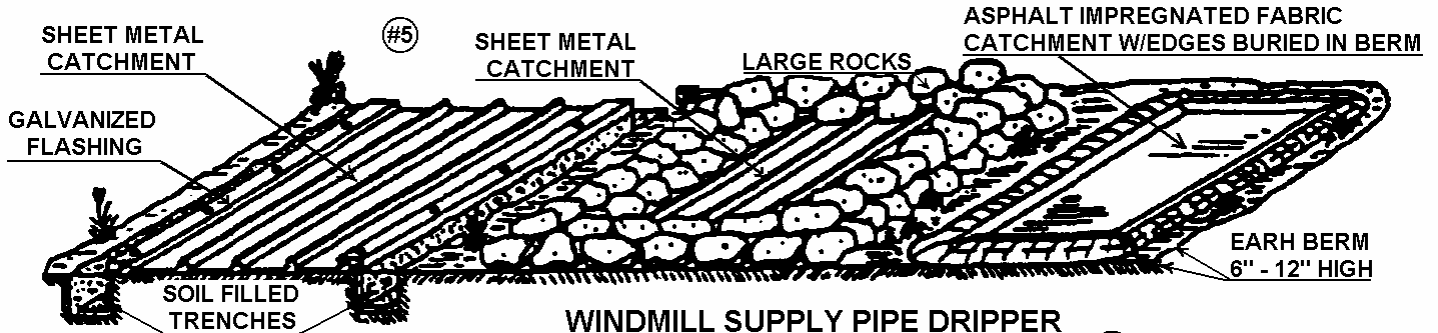

### IN-GROUND BOWL TROUGHS

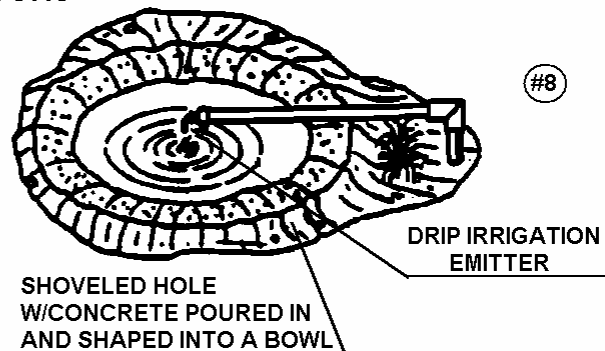

# WILDLIFE WATERING FACILITIES

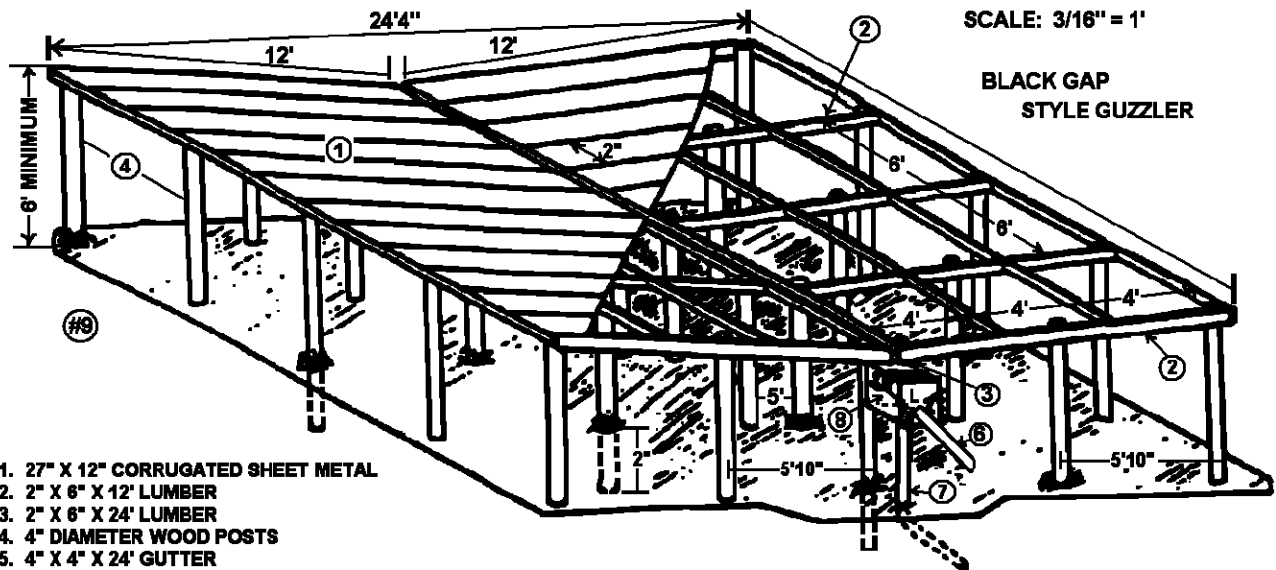

SCALE: 3/16" = 1'

BLACK GAP  
STYLE GUZZLER

1. 27" X 12" CORRUGATED SHEET METAL
2. 2" X 6" X 12' LUMBER
3. 2" X 6" X 24' LUMBER
4. 4" DIAMETER WOOD POSTS
5. 4" X 4" X 24' GUTTER
6. 3" MINIMUM DOWNSPOUT
7. ALTERNATE DIRECTION FOR DOWNSPOUT
8. 1'6" X 1'6" X 1' SUMP COVERED WITH 1/4" - 1/2" HARDWARE CLOTH

INVERTED UMBRELLA GUZZLER

SCALE: 3/16" = 1'

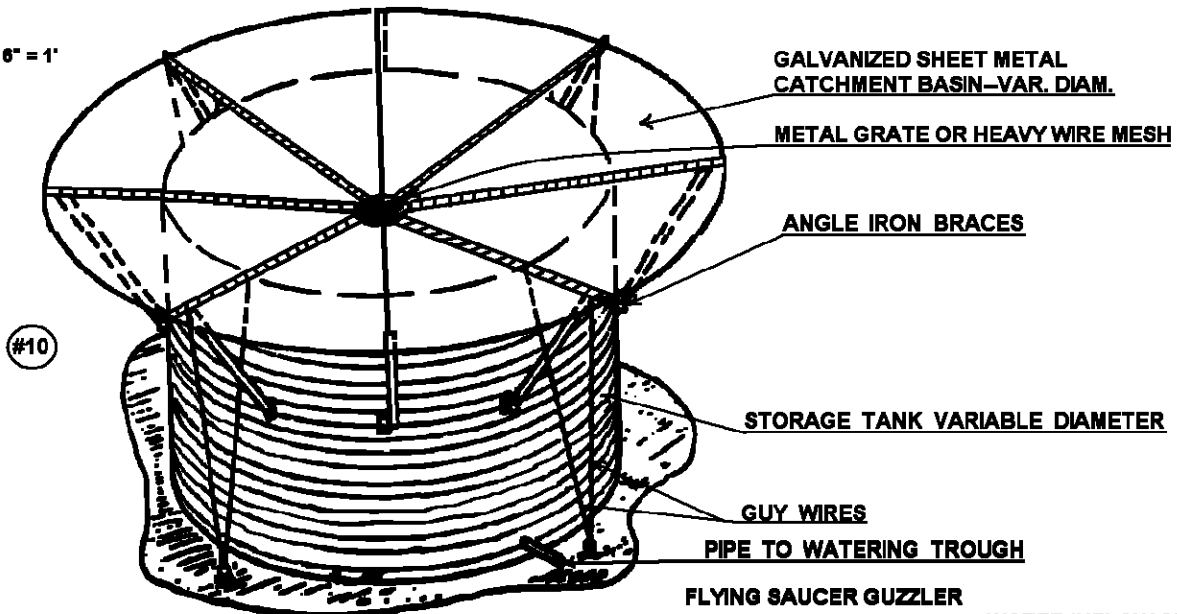

GALVANIZED SHEET METAL  
CATCHMENT BASIN-VAR. DIAM.

METAL GRATE OR HEAVY WIRE MESH

ANGLE IRON BRACES

STORAGE TANK VARIABLE DIAMETER

GUY WIRES

PIPE TO WATERING TROUGH

FLYING SAUCER GUZZLER

SCALE: 3/16" = 1'

VARIABLE DIAMETER GALVANIZED SHEET METAL  
CONED CATCHMENT

LINED WATERING TROUGH

WATER INFLOW SLOTS  
(WIRE MESH, COVERED)

VARIABLE DIAMETER STORAGE TANK

#11

# WILDLIFE WATERING FACILITIES

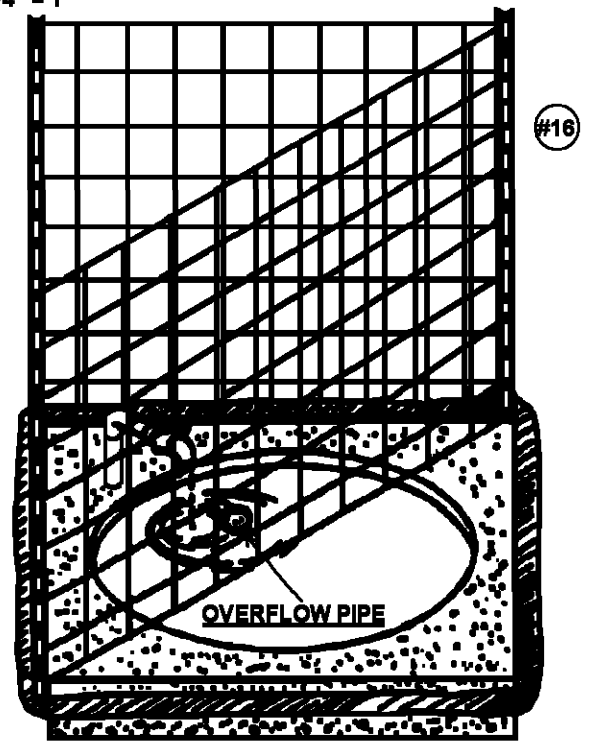
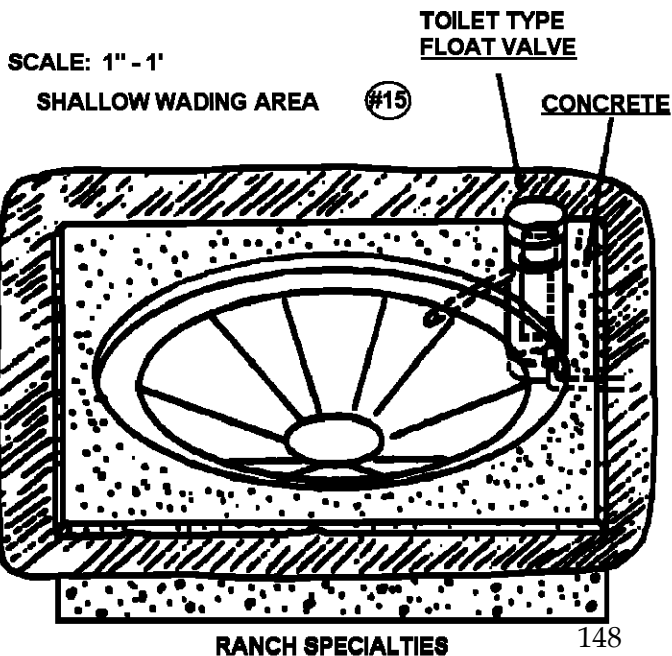
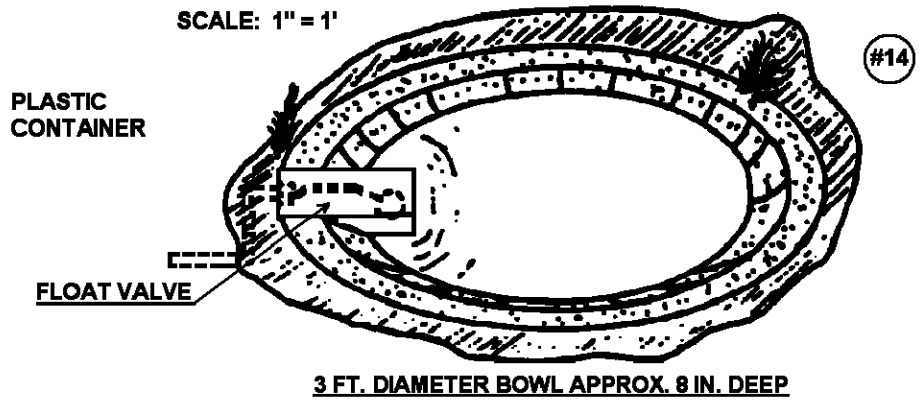
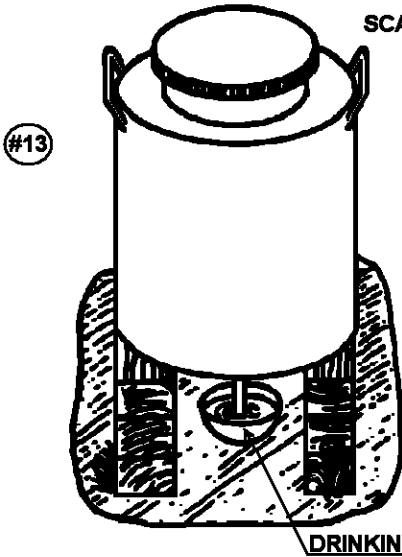
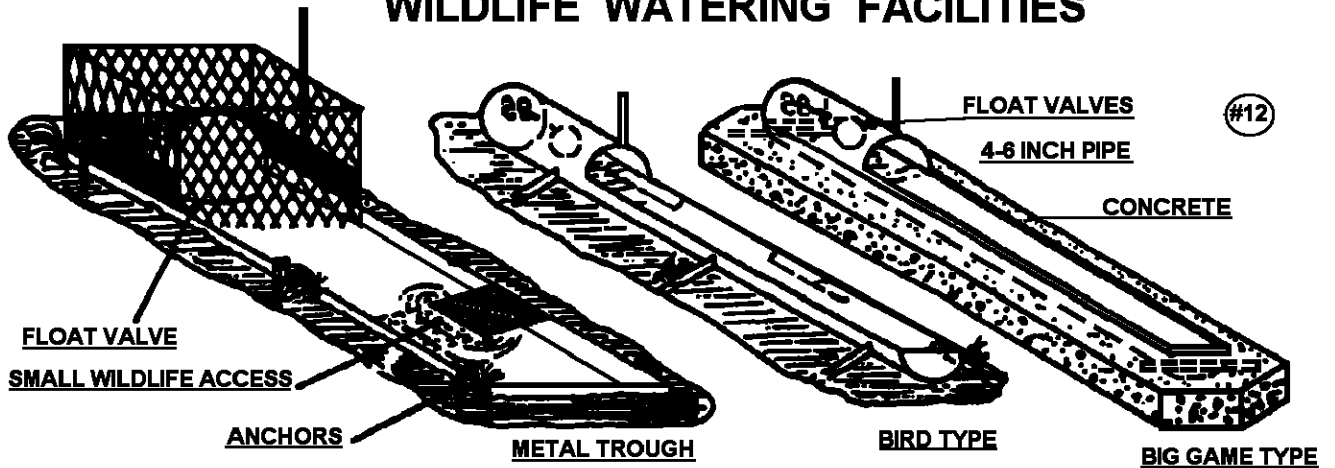





Appendix V

# Trapping Brown-headed Cowbirds to Control Songbird Nest Parasitism



# Trapping Brown-headed Cowbirds

The purpose of this guide is to assist landowners that wish to help songbird reproduction by building and operating a cowbird trap. Please note that all persons wishing to trap cowbirds should participate in the online training program before the trap is put into operation. This training is offered at no cost by **Texas Parks and Wildlife (TPW)**. All applicable state and federal laws must be observed during the duration of trapping. If questions arise, contact your closest **TPW** office for assistance.

## Why Trap Cowbirds?

Throughout North America songbird numbers are declining. While there is no one single reason for this decline, one major contributing factor is the spread of the brown-headed cowbird. These birds were once limited to the short-grass prairies, where they followed the herds of buffalo, feeding on the insects stirred up by the movement of herds as they moved from place to place. Today however, this highly adaptive bird is found throughout North America. This is a problem because of the reproductive strategies the species employs. The cowbird is what is referred to as a brood parasite. This means the female lays her eggs in the nests of other birds, abandoning them to the care of foster parents. The foster birds raise the cowbird chick to the detriment of their own young. Because the female cowbird can lay as many as 70 eggs per season, susceptible species of songbirds, such as the black-capped vireo and the golden-cheeked warbler, that are already endangered, are particularly at risk.

## Collecting Data

As with any scientific endeavor, cowbird trapping requires that data be collected in order to determine how effective it is. Collecting data also allows scientists to track the movements of banded birds, and hopefully to find new ways to reduce the parasitism rate that has caused many songbird populations to decline. By participating in this project landowners have the opportunity to help songbirds, and make a genuine contribution to the threatened and endangered wildlife in Texas.

Once the data has been collected, landowners should keep a copy, and forward a completed annual report to **Regional Migratory Bird Permitting Office for the U.S. Fish and Wildlife Service (USFWS)** by January 31<sup>st</sup> each year. This allows **USFWS** to monitor the total numbers of birds being trapped and the locations of the traps. Data to be collected should include the date, the number and type of non-target species that might get into the trap, the number of males, the number of females, and the numbers of banded birds that might be caught. *Banded birds are to be released* after the data is collected.

## Selecting a Trapping Location

The location of the trap is critical to maximize cowbird capture and to minimize non-target birds being caught. The idea is to put the trap in a place that is as attractive to cowbirds as possible, without being disruptive to other species. Ideally the trap should be located in areas that include the following:

- Close to where cattle or other livestock graze.

- In open pasture, away from any brush, and in low grass.
- The trap should be readily accessible to vehicles, even after heavy rain.
- Water and some perching snag (dead trees) nearby.

### Site Precautions

Even on a perfect location site there are precautions that should be taken to insure the safety of landowners and others participating in cowbird trapping.

One of the hazards to be aware of is that of predators. Any mammal, bird, or reptile that eats birds will be attracted to the traps in search of an easy meal. Keep the grass around the trap short. This will not only make it easier to spot snakes, but it will also make it more attractive to cowbirds. Raccoons and skunks will dig under the traps if precautions are not taken to keep them out. Owls and hawks also try to swoop down on the birds inside the trap. Fire ants can pose an additional hazard. Before using fire ant bait, check with your local Extension Service office for application recommendations. Always be sure to read and follow pesticide label directions. Never use any insecticides in the trap itself.

**TRAP OPERATION: It is suggested that traps be operated from March 1 to May 31 ONLY. This is to avoid incidental catch of non-target species. After May 31, fledglings of beneficial species such as cardinals, mockingbirds, buntings, and finches are most abundant and are more likely to be accidentally trapped.**

### Setting up the Trap

Erect the trap on a level site with no gaps between the frame and the ground. Use a shovel to fill in any gaps, if necessary.

Place a one gallon poultry waterer on level ground inside the trap. Scatter about a half a coffee can of cleaned milo (grain sorghum) on the ground, being careful to avoid getting it in the water. Do not feed milo during rainy weather because the birds do not like soggy grain. Wait until the ground has dried up before scattering it out again. Each trap must contain adequate food, water and shade and be checked daily.

Since cowbirds are gregarious birds, the traps work best if about 10-15 live cowbirds are present to act as decoys. When first starting a trap without decoys, be patient. If cowbirds are in the area, they'll find and enter the trap.

Use a large minnow dip or trout net to catch birds in the trap. You must **immediately release** any non-target bird species. Any bird not a cowbird is a non-target bird. Always remove and dispose of any dead or injured birds (usually a result of avian predator attack on the trap). The most common species of non-target birds that have been found in traps are mockingbirds, cardinals, various sparrows, grackles, blackbirds, and loggerhead shrikes. Consult a bird field guide to help you identify these species. Non-target birds will enter the traps for a variety of reasons. Some are attracted to the grain, some for company, and still others just out of curiosity. Putting a board across one side at the top to provide shade to trapped birds is recommended. Humanely treating birds while in the trap and humanely euthanizing birds is important.

If a federally permitted wildlife rehabilitator is within 1 hour or less of your capture efforts, you must send injured or debilitated non-target federally protected migratory

birds to the rehabilitator. If no rehabilitator is closer than 1 hour away, you may euthanize an injured or debilitated bird of a non-target species unless the species is federally listed as an endangered, threatened, or candidate species, in which case you must deliver it to a rehabilitator and report the take to the nearest U.S. Fish and Wildlife Service Field Office or Special Agent.

For a listing of endangered, threatened birds:

[http://tpwd.texas.gov/huntwild/wild/wildlife\\_diversity/nongame/listed-species/](http://tpwd.texas.gov/huntwild/wild/wildlife_diversity/nongame/listed-species/)

For a listing of U.S. Fish and Wildlife Service Offices:

<http://www.fws.gov/southwest/es/FieldOffices.html>

For a listing of U.S. Fish and Wildlife Special Agents:

<http://www.fws.gov/southwest/lawenforcement/statecontacts.html>

### **Euthanizing Cowbirds**

*This is the real job of protecting songbirds from nest parasitism. Whichever method is used to kill cowbirds, it must be humane, fast, and certain. The recommended method is cervical dislocation, or separating the vertebra.*

*Cervical dislocation: Hold top of neck between thumb and forefinger, grab head with other hand, turn and lift until you feel the cervical vertebrae detach from the head – HINT: hold the bird away from you when you do this the first few times until you have the “touch”. A catch box, net, gloves, and a light for night time are useful items to have on hand.*

*Alternative Dispatch Methods: Carbon dioxide (CO<sub>2</sub>) gas in a 5-gallon bucket may be used to euthanize brown-headed cowbirds. Use dry ice as the source of carbon dioxide. Cut a hole in the top of the bucket, cover opening with a piece of inner tube, or similar material, that has a slash in it to facilitate putting birds inside. Birds must not be touching the dry ice! Birds should be dead within 20 seconds.*

### **Taking Traps out of Operation**

Because cowbirds are a native species in North America, they are protected under the Migratory Bird Treaty Act. However, there are exceptions to this law for acts of depredation by a few select species. Under the **Texas Parks and Wildlife Code**, Section 64.002(c) brown-headed cowbirds are included among this small group of eight non-protected bird species that “may be killed at any time and their nests or eggs may be destroyed.” State regulations may not supersede federal regulations, so it is important that all participants in this project follow the protocols outlined here in this module. Again, it is recommended that no traps be in operation either before March 1, or after May 31.

If it is not possible to remove the trap to a location where it can be stored under cover, then certain precautions must be taken because birds, including non-target species, will tend to enter the trap. The traps may be taken out of operation by placing boards over the entry slots or by securing the door in an open position. Be sure to remove all cowbirds, and release any banded birds, disposing of any dead or injured birds.

### **Reporting the Data**

Be sure to record all data on birds captured on an approved data form and forward copies to United States Fish and Wildlife Office in Albuquerque, New Mexico. Landowners who are actively participating in trapping brown-headed cowbirds must submit their data by January 31<sup>st</sup> each year. Submit data to:

U.S. Fish and Wildlife Service  
Regional Migratory Bird Permit Offices  
P.O. Box 709  
Albuquerque, NM 87103

## Materials List for 6x8 Portable Wood Cowbird Trap

Number	Description	Comments
16	2x4x8 (treated)	Rip 2x4 into 2x2
2	Sheets ½" CDX plywood	1 sheet is for slot assembly, 1 sheet is to cut up for gussets.
64 linear ft	½" mesh hailscreen	Bought in 100 ft. rolls
1 pair	Tight pin hinges (3")	Door hinges
1	Screen door-handle	Outside of door
1	Galvanized hasp (4½")	Use with padlock for security
1	Screen door latch	Used on inside of door
14	10"x12" shelf brackets	Used to square panels (2 per panel)
125 (approx)	1" drywall screws	Field assembly of slot assembly, attaching shelf brackets to panels.
50 (approx)	3" galvanized deck screws	Field assembly (panel to panel)
300 (approx)	1½" pneumatic staples	Used attach gussets
600 (approx)	1 pneumatic staples	Used to attach screen to panels
300 (approx)	½" staples	Used to attach screen to slot assembly

### Recommended Tools For Construction

#### Shop Assembly of Panels

Table saw – for ripping 2x2  
 Chop saw – for cutting boards to length  
 Electric hand saw – for cutting out gussets and slot assembly  
 Retractable rule – for measuring dimensions  
 Electric or cordless drill/driver – for driving screws  
 Pneumatic or electric nibbler – for cutting hail screen  
 Pneumatic stapler – for attaching gussets and wire  
 Pneumatic nailer – for assembly of panels  
 (optional but helpful – Panels can be assembled with 3" deck screws if nailer is not available.)

#### Field Assembly

Cordless drill/driver – for driving screws  
 Bar of soap – to lubricate screw threads  
 Hand stapler – to secure wire to ends of drop entrance  
 Step ladder – for attaching top panels

# Construction Tips

- Use treated lumber throughout. Added initial cost is compensated for by longer field life and reduced maintenance.
- Don't rip lumber until you are ready to start construction. Ripped lumber will bow and twist if allowed to sit for several days.
- Use a shelf bracket on diagonal corners to square each panel before attaching gussets. To cut gussets, lay out sheet of plywood in 12" squares, then draw diagonals across the square. A sheet of plywood will make 64 gussets.
- Gussets go on one side of panel, hailscreen attaches to the other side. For side and top panels, wire will end up being on the inside on the panel. This prevents birds from roosting on framework next to wire where they are prone to predation. **Exception:** End panels are constructed the same way, but during final trap assembly, the wire goes on the outside, because the drop entrance attaches to horizontal members for structural stability.
- This pattern is designed to use 48" wide hailscreen to maximize efficiency. Internal cross members are placed to allow for slight overlap. Wide hailscreen will probably not be readily available in stock, but any building supply can order it. Use of narrower hailscreen requires repositioning of tack strips, and results in higher lumber use.
- To maximize shop efficiency: cut gussets; rip lumber; pre-cut lengths; cut out slot assembly; assemble side, top, and end panels; attach hailscreen; final assembly. When building multiple units, performing similar actions for several traps at the same time will allow you to develop an assembly line process that cuts construction time per unit.
- **Slot width of 1.25 inches in slot assembly is critical.** Wider slots will increase non-target captures, including small raptors, which will feed on your decoy birds. Escapes by females may also increase with wider slots.
- Side panels attach to the outside of end panels. Nothing else will fit if you attach ends outside.
- During final assembly assemble in this order: end, side, side, top, top, dropping slot assembly (3 pieces), then finish with the other end.





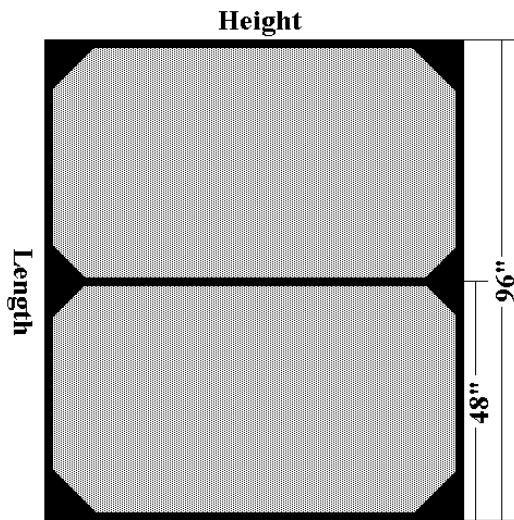

Left Side Panel (same as right panel)

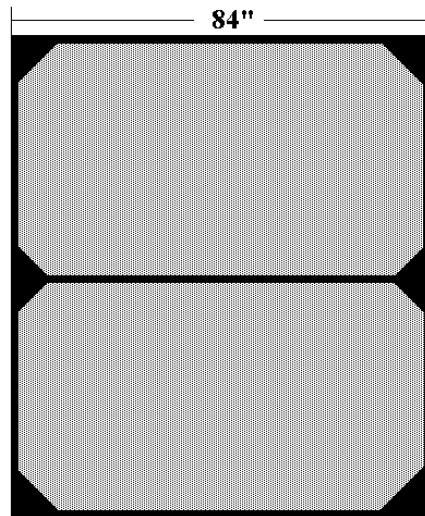

Right Side Panel

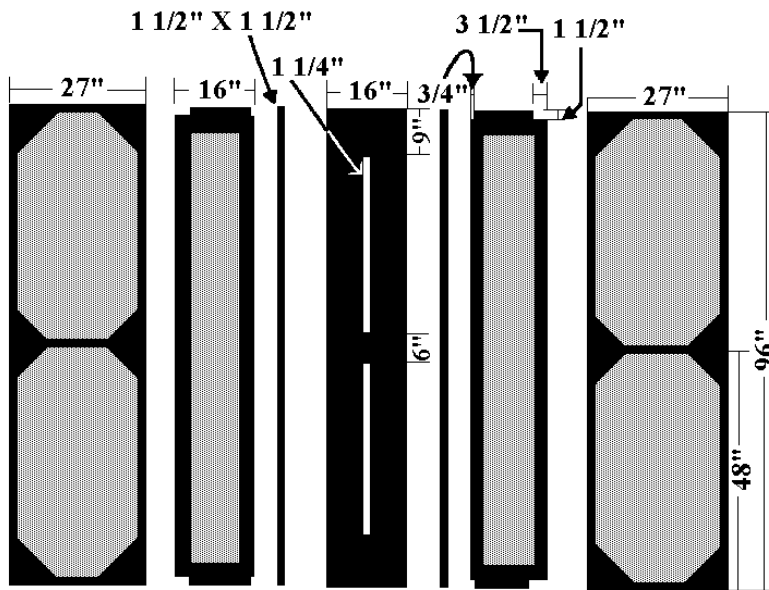

Top Panel/Slot Assembly

End View of Top Panel/Slot Assembly

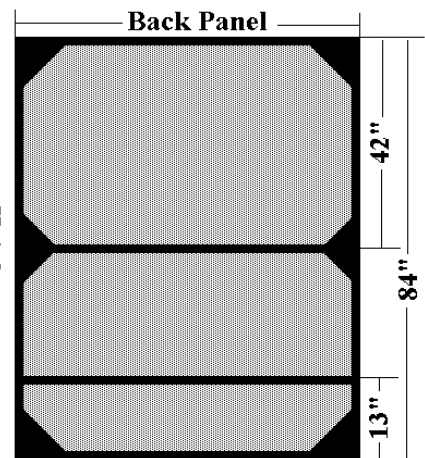

Back Panel

# Cowbird Trap Plans

Plans developed by Fort Hood Environmental Division.

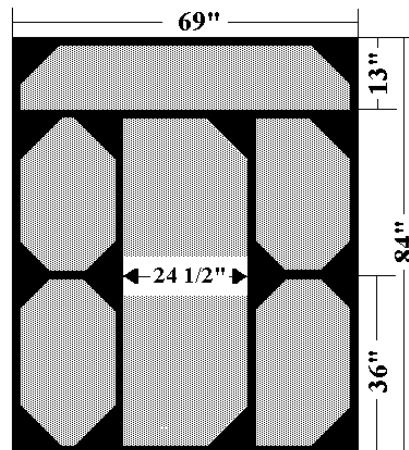

Front Panel

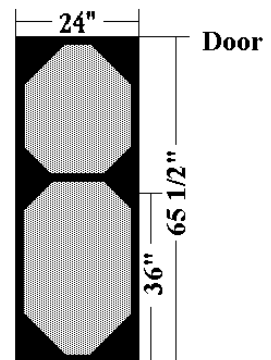

Door

# Materials List for 6x8 Portable Metal Cowbird Trap

Number	Description	Comments
300	1 ½" fender washers*	attach wire to the trap frame
210 ft.	1 ½" 14 gauge square tubing	frame
16 ft.	1 ½" x 1 ½" x ⅛" angle iron	trap funnel base
15" w x 94 ½" lg	⅛" plate*	funnel entrance floor
2	2" weld-on hinges*	door hinge
1	weld-on door latch*	used to keep door secured
50 ft. of 48"	½" hardware cloth	bought in 100 ft. rolls
40 ft. of 36"	½" hardware cloth	bought in 100 ft. rolls

## Recommended Tools:

220 amp electric wire feed welding machine	Vise-grip pliers
Oxyacetylene cutting torch or pipe saw	6 3 or 4 inch C-clamps
Electric drill and metal bits	Metal measuring tape
Driver for self-tapping metal screws	Wire brush
Hacksaw	Wire shears or tin snips
Hammer	Metal dirt rake

## Order of Construction: *(Refer to diagram for placement before welding)*

### Sides (Cuts necessary for both sides)

- 2 cuts 96" of 1 ½" x 1 ½" 14 gauge square tubing (top of side panels).
- 2 cuts 96" of 1 ½" x 1 ½" heavy gauge square tubing (base of side panels).
- 4 cuts 81" of 1 ½" x 1 ½" 14 gauge square tubing (vertical corner posts).
- 2 cuts 93" of 1 ½" x 1 ½" 14 gauge square tubing (center braces).

### Front

- 2 cuts 72" of 1 ½" x 1 ½" 14 gauge square tubing (door headers).
- 1 cut 72" of 1 ½" x 1 ½" heavy gauge square tubing (base piece).
- 2 cuts 11" of 1 ½" x 1 ½" 14 gauge square tubing (bracing over the door).
- 2 cuts 22 ¼" of 1 ½" x 1 ½" 14 gauge square tubing (mid-section bracing by door).
- 2 cuts 68 ½" of 1 ½" x 1 ½" 14 gauge square tubing (doorframe).

### Door

- 3 cuts 21" of 1 ½" x 1 ½" 14 gauge square tubing (top, middle, bottom bracing).
- 2 cuts 68" of 1 ½" x 1 ½" 14 gauge square tubing (sides of door).

### Back

- 3 cuts 72" of 1 ½" x 1 ½" 14 gauge square tubing (top, center frame pieces).
- 1 cut 72" of 1 ½" x 1 ½" heavy gauge square tubing (base piece).
- 2 cuts 11" of 1 ½" x 1 ½" 14 gauge square tubing (top bracing pieces).

## Top

2 cuts 93" of 1 1/2" x 1 1/2" 14 gauge square tubing (upper frame for trap funnel).  
2 cuts 93" of 1 1/2" x 1 1/2" x 1/8" angle iron. (lower trap entrance plate supports).  
15" wide x 94 1/2" long 1/8" plate (trap entrance plate). Cut two openings 36 1/4" x 1 1/4" as shown in the diagram. *The exact 1 1/4" width of each opening is critical. (Note: If desired, this plate can be made of wood, rather than metal.)*

## **Wire Mesh covering**

Center the wire at the door and wrap it around the entire trap, using a dirt rake to pull the wire tight. Don't forget to cover the floor of the trap (this will help keep predators out). Attach the wire to the frame with fender washers and self-tapping screws placed every 12 inches apart.

Door: 1 piece 67 3/4" x 23 1/2". Trim to fit.

### *Placement Notes:*

- A. 1/4" gap on hinge side of door between door and frame.
- B. Hinge starts 10" from the top.
- C. Hinge starts 10" from the bottom.

## **\*ALTERNATE CONSTRUCTION METHODS**

### Attaching Wire Mesh (Alternate Method)

If desired, the screen mesh can be attached to the trap using 130 feet of 1" x 1/8" strap, and 275 self-tapping metal screws. Make the following cuts if this method is used:

Front: 2 – 74 1/2"	Both Sides: 6 – 95 3/4"
2 – 23 1/2"	4 – 6"
2 – 27 1/2"	
2 – 11"	Rear: 3 – 74 1/2"
	2 – 11 1/2"
Door: 3 – 23 1/2"	1 – 19"
2 – 21" (upper sides)	
2 – 42 3/4" (lower sides)	Center Trap Angle: 2 – 93"

Hold all screen in place with 1" x 1/8" plate with screws placed every 6 inches.

### Alternate Door Hinges and Latch Construction:

*Note: Put door latch on first, then install frame latch to fit.*

1 ft. of 1" x 1/4" strap  
2 ft. of 3/8" tubing  
2 ft. of 7/16" rod

### Make the following cuts:

4 cuts 2" of 3/8" tubing (door hinge part)

2 cuts 5" of 7/16" rod (door hinge part)  
1 cut 7" of 1" x 1/4" strap (door latch)  
1 cut 5" of 1" x 1/4" strap (on door)  
1 cut 2" of 3/8" tubing (on door)  
1 cut 3 1/4" 7/16" rod

Alternate Trap Entrance Plate:

2 pieces of plate 7" wide x 94 1/2" long, separated by 1 1/4" inches that will form the opening. *The exact 1 1/4" width of the opening is critical.*

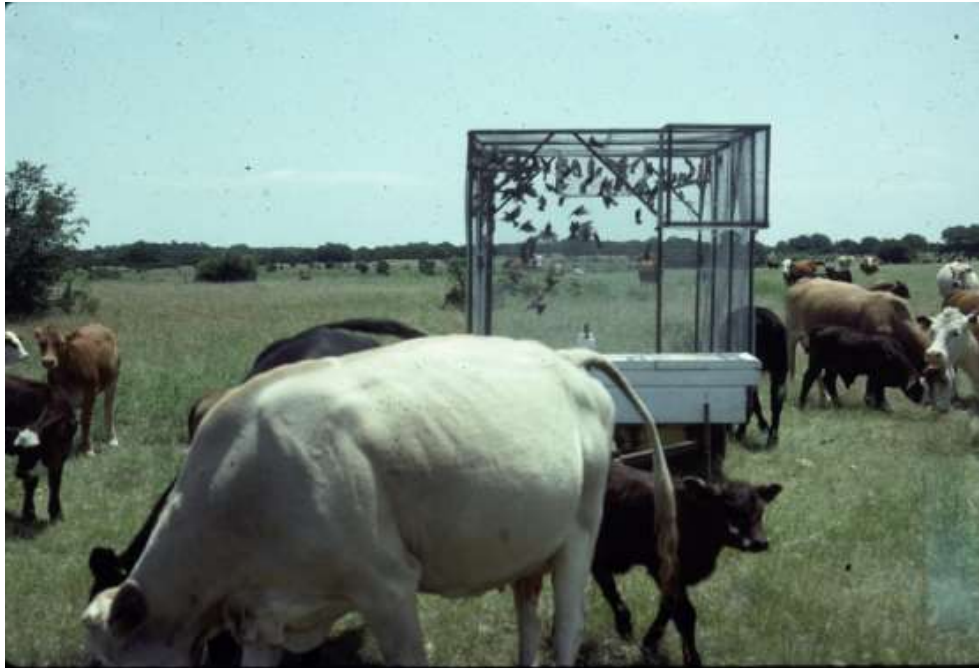

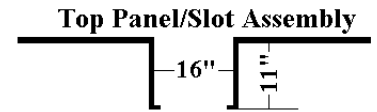
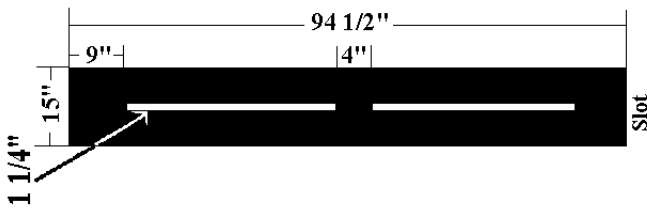
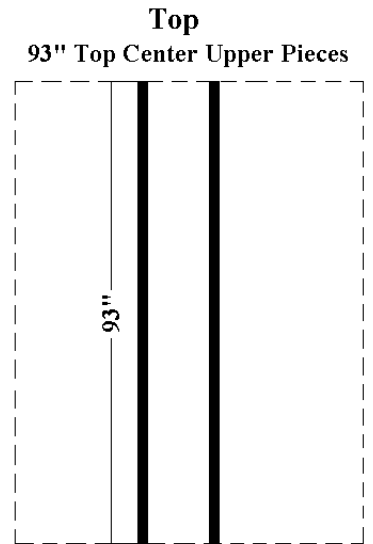
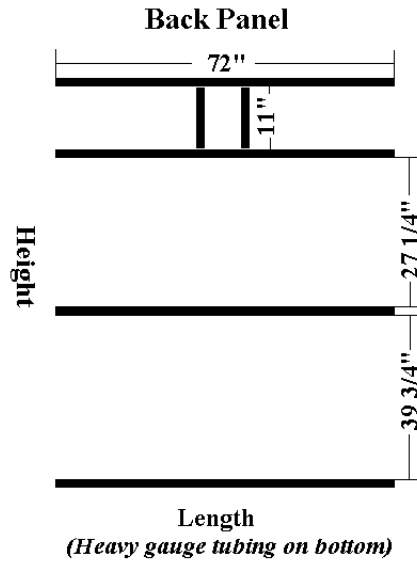
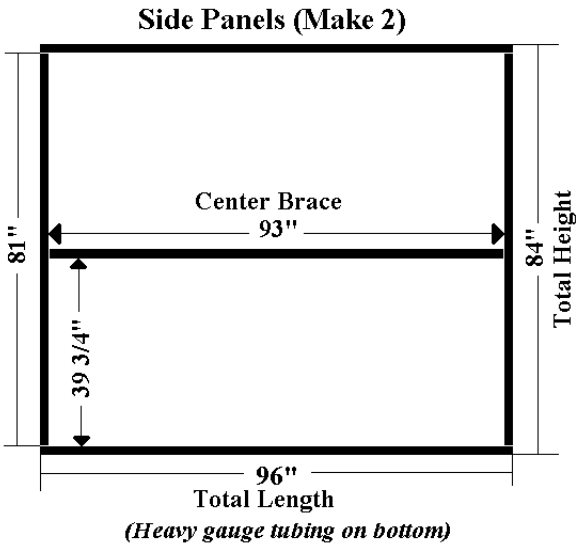

**End View of Top Panel/Slot Assembly**  
Lower Cross pieces 93" angle iron

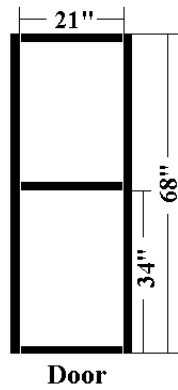
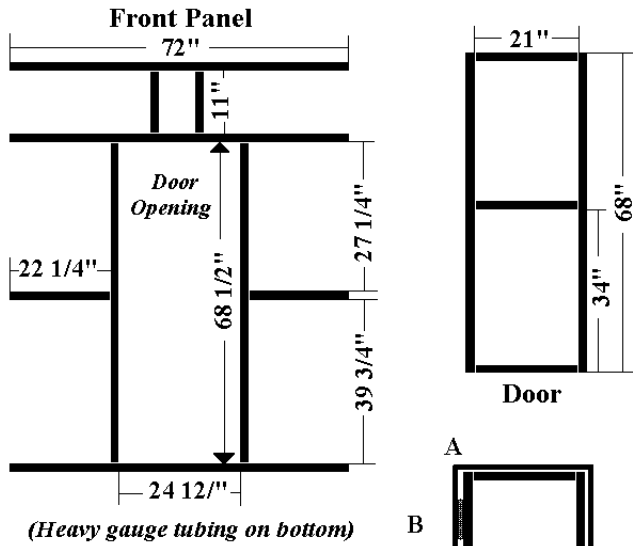

**Door Latch Assembly**

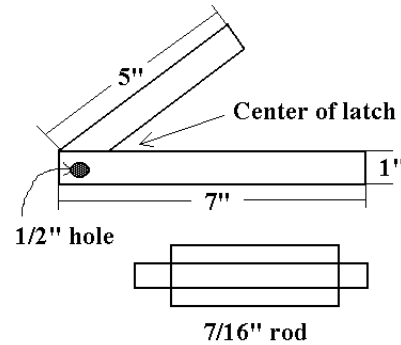

Weld rod to both sides of latch

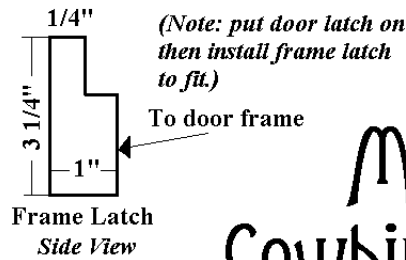

(Note: put door latch on then install frame latch to fit.)

- A. 1/4" gap between hinge side of door between door and frame.
- B. Hinge starts 10" from top.
- C. Hinge starts 10" from bottom.

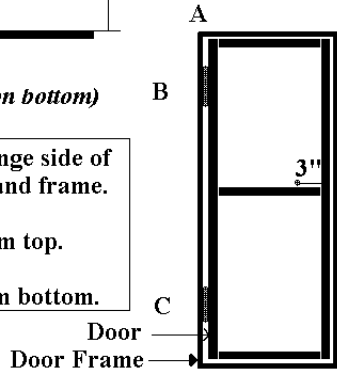

# Metal Cowbird Trap Plans

## Appendix W

# FORMS

### Forms contained in this appendix include:

**PWD 153-7100-10/03: Landowner Request for Technical Assistance.** Landowners desiring technical assistance from Texas Parks and Wildlife Department should fill in this form and mail it to their local biologist.

**PWD 885-W7000: 1-d-1 Open Space Agricultural Valuation Wildlife Management Plan.** Landowners wishing to manage their property for wildlife as their agricultural practice must fill in and attach this form to their **1-d-1 Open Space Agricultural Valuation Application** form that is available from the county Central Appraisal District. *Do not return this form to Texas Parks and Wildlife Department.*

**PWD 885-W7000: 1-d-1 Open Space Agricultural Valuation Annual Reporting Form.** This form is not automatically required. For counties requesting a landowner report on wildlife management activities, this form will be provided to the landowner by the Chief Appraiser. *Do not return this form to Texas Parks and Wildlife Department.*





# LANDOWNER REQUEST FOR TECHNICAL GUIDANCE



1. I hereby request technical assistance of the Texas Parks and Wildlife Department, Wildlife Division field staff, in my efforts to enhance habitat and manage wildlife populations on lands under my control.
2. Permission is granted to the Texas Parks and Wildlife Department, Wildlife Division field staff, to enter upon these lands and conduct, at a mutually agreeable time, wildlife and habitat inventories which may include the use of ground vehicles, aircraft, or nighttime spotlight counts to gather data necessary for the development of management recommendations.

Section 12.0251 of the Parks and Wildlife Code provides that information collected in response to a landowner request for technical guidance on private land relating to the specific location, species identification or quantity of any animal or plant life is confidential and may not be disclosed. The Department may release game census, harvest, habitat or program information if the information is summarized in a manner that prevents the identification of an individual or specific parcel of land and the landowner.

**3. I understand that recommendations will be provided to me in the form of oral and/or written guidelines, which are non-binding and voluntary on my part. By my signature, I certify that I am the owner of the below-described property or that I have been specifically authorized by the landowner to act as their agent in this matter.**

Signed: \_\_\_\_\_  
 Landowner or Authorized Agent Date

Name of Property: \_\_\_\_\_

County: \_\_\_\_\_ Acres: \_\_\_\_\_

City, State, Zip: \_\_\_\_\_

Phone Number(s):

Home: \_\_\_\_\_ Office: \_\_\_\_\_ Other \_\_\_\_\_

Title V Compliance: The Texas Parks and Wildlife Department provides this service to land managers without discrimination in respect to race, color, national origin, age or handicap.

**Texas Parks and Wildlife Department maintains the information collected through this form. With few exceptions, you are entitled to be informed about the information we collect. Under Sections 552.021 and 553.023 of the Texas Government Code, you are also entitled to receive and review the information. Under Section 559.004, you are also entitled to have this information corrected. For assistance call 512-389-4959.**



# 1-D-1 Open Space Agricultural Valuation Wildlife Management Plan for the Year (s) \_\_\_\_\_

Submit this plan to your County Chief Appraiser, not to Texas Parks and Wildlife Department

## Part I. Owner Information

Account Number: \_\_\_\_\_

Owner's Name: \_\_\_\_\_

Current mailing address: \_\_\_\_\_

City, town, post office, state and zip code: \_\_\_\_\_

Phone number: \_\_\_\_\_

Tract Name: \_\_\_\_\_ Majority County: \_\_\_\_\_

Additional Counties (if any): \_\_\_\_\_

## Part II. Property Description

Legal Description of Property: \_\_\_\_\_

Location of Property (distance and direction from nearest town; specify highway/road numbers): \_\_\_\_\_

Is Acreage under high fence:  Yes  No  Partial: (Describe) \_\_\_\_\_

Total Acreage: \_\_\_\_\_ Ecoregion \_\_\_\_\_  
*(refer to Comprehensive Wildlife Management Planning Guidelines)*

Habitat Types and Amounts of Acres:

Cropland \_\_\_\_\_  Bottomland/Riparian \_\_\_\_\_  wetlands \_\_\_\_\_  
Native

Non-native Pasture \_\_\_\_\_  Pasture/Grassland \_\_\_\_\_  timberlands \_\_\_\_\_

Native Range/Brush \_\_\_\_\_  Other (describe) \_\_\_\_\_

## III. Species targeted for management. (List all that apply. Attach additional page(s) if needed)

Deer  turkey  quail  songbirds  waterfowl  doves  bats

Neotropical songbirds (List) \_\_\_\_\_

Reptiles (list) \_\_\_\_\_  Amphibians (list) \_\_\_\_\_

Small mammals (list) \_\_\_\_\_  Insects (list) \_\_\_\_\_

Identified species of concern (List) \_\_\_\_\_

Other (List) \_\_\_\_\_



**Part IV. Management Plan Goals and Objectives**

Describe the wildlife management **goals** (what you want the property to look like, or want to be able to do with it) and **objectives** (how you intend to achieve these goals) for this piece of property. You may use an additional page if needed. (Note: This space will expand as you type.)

**Part V. Qualifying Wildlife Management Activities**

**Check the wildlife management practices to be implemented on the property during the coming year that will support and achieve your management goals. A minimum of three practices is required.**

<input type="checkbox"/> Habitat control	<input type="checkbox"/> Provide supplemental supplies of water
<input type="checkbox"/> Erosion control	<input type="checkbox"/> Provide supplemental supplies of food
<input type="checkbox"/> Predator control	<input type="checkbox"/> Provide shelters
<input type="checkbox"/> Making census counts to determine population.	

**Part VI. White tail Deer and Mule Deer Population Management**

Is hunting to be a part of this wildlife management plan?  Yes  No  
If YES, type of hunting:  Lease hunting  Family/guests only  Both  
List deer harvest for past three seasons:  
Year: \_\_\_\_\_ Bucks: \_\_\_\_\_ Does: \_\_\_\_\_  
Year: \_\_\_\_\_ Bucks: \_\_\_\_\_ Does: \_\_\_\_\_  
Year: \_\_\_\_\_ Bucks: \_\_\_\_\_ Does: \_\_\_\_\_  
Population Management Goals:  
Target Density for Pre-season Deer Population (fall density) \_\_\_\_\_  
Target Sex Ratio (does/buck): \_\_\_\_\_  
Target Production (fawns/doe): \_\_\_\_\_  
Other (may be age, weight, antler measurements, browse conditions, etc.) \_\_\_\_\_  
Deer Harvest Strategy (numbers, types of deer to be harvested to achieve goals): \_\_\_\_\_

**Part VII. Wildlife Management Association Membership**

Are you a member of a wildlife management association (co-op)?  Yes  No  
Are you a member of a wildlife property association?  Yes  No  
Name of wildlife property co-op/association, if YES is checked. \_\_\_\_\_

**Part VIII. Wildlife Management Activities**

Check the activities you intend to implement during the year to support each of the wildlife management activities listed in Part V.

<p><b>1. HABITAT CONTROL</b></p> <p><input type="checkbox"/> <i>Grazing management.</i> Check grazing system being utilized.</p> <p><input type="checkbox"/> 1 herd/3pasture    <input type="checkbox"/> 1 herd/4 pasture    <input type="checkbox"/> 1 herd/multiple pasture</p> <p><input type="checkbox"/> High intensity/low frequency (HILF)    <input type="checkbox"/> Short duration system</p> <p><input type="checkbox"/> Other type of grazing system (describe) _____</p> <p><i>Additional Information:</i> _____</p>
<p><input type="checkbox"/> <i>Prescribed Burning</i></p> <p>Acres to be burned: _____ Planned burn date: _____</p> <p><i>Additional Information:</i> _____</p>
<p><input type="checkbox"/> <i>Range Enhancement (Range Reseeding)</i></p> <p>Acres to be seeded: _____ Date to be seeded: _____</p> <p>Seeding Method: <input type="checkbox"/> Broadcast    <input type="checkbox"/> Drilled    <input type="checkbox"/> Native Hay</p> <p>Seeding mixture to be used: _____</p> <p>Fertilized: <input type="checkbox"/> Yes    <input type="checkbox"/> No</p> <p>Weed control needed for establishment? <input type="checkbox"/> Yes    <input type="checkbox"/> No</p> <p><i>Additional Information:</i> _____</p>
<p><input type="checkbox"/> <i>Brush Management.</i> Acres to be treated: _____ Check method of brush management:</p> <p><input type="checkbox"/> Mechanical</p> <p><input type="checkbox"/> grubber    <input type="checkbox"/> chain    <input type="checkbox"/> roller chopper/aerator    <input type="checkbox"/> rhome disc</p> <p><input type="checkbox"/> brush hog (shredder)    <input type="checkbox"/> dozer    <input type="checkbox"/> hand-cutting (chainsaw)</p> <p><input type="checkbox"/> hydraulic shears    <input type="checkbox"/> other (describe): _____</p> <p><input type="checkbox"/> Chemical Kind: _____ Rate: _____</p> <p><input type="checkbox"/> Brush management design:</p> <p><input type="checkbox"/> block    <input type="checkbox"/> mosaic    <input type="checkbox"/> strips: width: _____ Length: _____</p> <p><i>Additional Information:</i> _____</p>
<p><input type="checkbox"/> <i>Fence Modification</i></p> <p>Target species: <input type="checkbox"/> pronghorn antelope    <input type="checkbox"/> bighorn sheep</p> <p>Technique: <input type="checkbox"/> fold up bottom of net-wire    Gap width: _____</p> <p><input type="checkbox"/> replace sections of net-wire with barbed wire. Gap width: _____</p> <p>Miles of fencing that will be modified: _____</p> <p><input type="checkbox"/> replace entire net-wire fence with barbed wire. Miles replaced: _____</p> <p><i>Additional Information:</i> _____</p>

*Riparian management and enhancement*

Fencing of riparian area

Complete fencing     Partial fencing

Deferment from livestock grazing

Complete deferment     partial deferment    Season deferred : \_\_\_\_\_

Establish vegetation

Trees (list species) \_\_\_\_\_

Shrubs (list species) \_\_\_\_\_

Herbaceous species (list) \_\_\_\_\_

*Additional Information:* \_\_\_\_\_

*Wetland enhancement*

Provide seasonal water     Provide permanent water     Moist soil management

Other (describe) \_\_\_\_\_

*Additional Information:* \_\_\_\_\_

*Habitat Protection for species of concern*

Fencing     Firebreaks     Prescribed burning     Control of nest parasites

Habitat manipulation (thinning, etc.)     Native/exotic ungulate control

Other (describe) \_\_\_\_\_

*Additional Information:* \_\_\_\_\_

*Prescribed Control of Native, Exotic and Feral Species*

Prescribed control of vegetation

Prescribed control of animal species

Species being controlled: \_\_\_\_\_

Method of control: \_\_\_\_\_

*Additional Information:* \_\_\_\_\_

*Wildlife Restoration*

Habitat restoration

Wildlife restoration

Target species: \_\_\_\_\_

Method of restoration: \_\_\_\_\_

*Additional Information:* \_\_\_\_\_

## 2. EROSION CONTROL

*Pond construction and repair*

Surface area (acres): \_\_\_\_\_ Number of cubic yards of soil displaced: \_\_\_\_\_

Length of dam (feet): \_\_\_\_\_ Planned date of construction: \_\_\_\_\_

Additional Information: \_\_\_\_\_

*Gully shaping*

Total acres to be treated: \_\_\_\_\_ Acres treated annually: \_\_\_\_\_

Seeding mix used for reestablishment of vegetation: \_\_\_\_\_

Planned date of construction: \_\_\_\_\_

Additional Information: \_\_\_\_\_

*Streamside, pond, and wetland revegetation.* Techniques used:

Native hay bales  Fencing  Filter strips  Seeding upland buffer

Rip-rap, etc.  stream crossings  Other: \_\_\_\_\_

Planned date of construction: \_\_\_\_\_

Additional Information: \_\_\_\_\_

*Herbaceous and/or woody plant establishment on critical areas (erodible)*

Establish windbreak  Establish shrub mottes  Improve plant diversity

Improve wildlife habitat  Conservation/no-till practices  Manage CRP cover

Additional Information: \_\_\_\_\_

*Dike/Levee Construction/Management*

Reshaping/repairing erosion damage  Revegetating/stabilize levee areas

Install water control structure  Fencing

Additional Information: \_\_\_\_\_

*Establish water diversion*

Type:  Channel  Ridge

Slope:  level  graded Length (feet) \_\_\_\_\_

Vegetated:  No  YES

If YES:  Native: \_\_\_\_\_  Crop: \_\_\_\_\_

Additional Information: \_\_\_\_\_

**3. PREDATOR CONTROL**

- Imported red fire ants (verify prior to application that product is labeled for pasture use)
  - Control of cowbirds       Grackle/starling/house sparrow control  
Method of control:  Trapping    Shooting    Baiting    Scare tactics \_\_\_\_\_
  - Coyotes    Feral hogs    Raccoon    Skunk    Bobcat    Mountain lion
  - Rat snakes    Feral cats/dogs  
Method of control:  Trapping    Shooting                       M-44 (licensed applicators)  
 Poison collars (1080 certified, licensed, applicator)    Other \_\_\_\_\_
- Additional Information:* \_\_\_\_\_

**4. SUPPLEMENTAL WATER**

- Marsh/Wetland Restoration or Development*
    - Greentree reservoirs    Shallow roost pond development    Seasonally flooded crops
    - Artificially created wetlands       Marsh restoration/development/protection
    - Prairie pothole restoration/development/protection    Moist soil management units
- Planned date of construction: \_\_\_\_\_
- Additional Information:* \_\_\_\_\_

- Well/trough/windmill overflow/other wildlife watering facilities*
    - Drill new well      Depth: \_\_\_\_\_      Gallons per minute: \_\_\_\_\_
      - Windmill    Pump    Pipeline:   Size \_\_\_\_\_   Length: \_\_\_\_\_
    - Modification(s) of existing water source
      - Fencing    Overflow    Trough modification    Pipeline
- Distance between water sources (waterers): \_\_\_\_\_
- Type of wildlife watering facility
- |   |  |
|---|--|
| <input type="checkbox"/> PVC pipe facility      # _____     | <input type="checkbox"/> Drum with faucet or float      # _____    |
| <input type="checkbox"/> Small game guzzler      # _____    | <input type="checkbox"/> Windmill supply pipe dripper      # _____ |
| <input type="checkbox"/> Plastic container      # _____     | <input type="checkbox"/> In-ground bowl trough      # _____        |
| <input type="checkbox"/> Big game guzzler      # _____      | <input type="checkbox"/> Inverted umbrella guzzler      # _____    |
| <input type="checkbox"/> Flying saucer guzzler      # _____ | <input type="checkbox"/> Ranch Specialties guzzler      # _____    |
| <input type="checkbox"/> Other: _____                       |  |
- Additional Information:* \_\_\_\_\_

- Spring development and/or enhancement*
    - Fencing    Water diversion/pipeline    Brush removal    Spring clean out
    - Other: \_\_\_\_\_
- Additional Information:* \_\_\_\_\_

## 5. PROVIDING SUPPLEMENTAL FOOD

- Grazing management       Prescribed burning       Range enhancement
- Food plots      Size: \_\_\_\_\_ Fenced:  Yes     No
- Irrigated:     Yes                       No
- Plantings:     Cool season annual crops: \_\_\_\_\_
- Warm season annual crops: \_\_\_\_\_
- Annual mix of native plants: \_\_\_\_\_
- perennial mix of native plants: \_\_\_\_\_

*Additional Information:* \_\_\_\_\_

*Feeders and mineral supplementation*

Purpose:  Supplementation       Harvesting of wildlife

Targeted wildlife species: \_\_\_\_\_

Feed type: \_\_\_\_\_ Mineral type: \_\_\_\_\_

Feeder type: \_\_\_\_\_ Number of feeders: \_\_\_\_\_

Method of mineral dispensing: \_\_\_\_\_

Number of mineral locations: \_\_\_\_\_

Year round:  Yes     No      If not, state when: \_\_\_\_\_

*Additional Information:* \_\_\_\_\_

*Managing tame pasture, old fields and croplands*

Overseeding cool and/or warm season legumes and/or small grains

Periodic disturbance (Discing/Mowing/Shredding)     Conservation/no-till

*Additional Information:* \_\_\_\_\_

*Transition management of tame grass monocultures*

Overseed 25% of tame grass pastures with locally adapted legumes

Species planted:  Clover     Peas     Vetch     Other: \_\_\_\_\_

*Additional Information:* \_\_\_\_\_

## 6. PROVIDING SUPPLEMENTAL SHELTER

*Nest boxes*      Target Species: \_\_\_\_\_

Cavity type. # \_\_\_\_\_  Bat boxes. # \_\_\_\_\_  Raptor pole. # \_\_\_\_\_

*Additional Information:* \_\_\_\_\_

*Brush piles and slash retention*

Type:       Slash       Brush piles      Number per acre: \_\_\_\_\_

*Additional Information:* \_\_\_\_\_

*Fence line management* Length: \_\_\_\_\_ Initial establishment:  Yes  No  
Plant type established:  Trees  Shrubs  Forbs  Grasses  
*Additional Information:* \_\_\_\_\_

*Hay meadow, pasture and cropland management for wildlife* Acres treated: \_\_\_\_\_  
Shelter establishment:  Roadside management  Terrace/wind breaks  Field borders  
 shelterbelts  Conservation Reserve Program lands management  
Type of vegetation:  Annual  Perennial  
Species and percent of mixture \_\_\_\_\_  
 Deferred mowing Period of deferment: \_\_\_\_\_  
 Mowing Acres mowed annually: \_\_\_\_\_  
 No till/minimum till  
*Additional Information:* \_\_\_\_\_

*Half-cutting trees or shrubs*  
Acreage to be treated annually: \_\_\_\_\_ Number of half-cuts annually: \_\_\_\_\_  
*Additional Information:* \_\_\_\_\_

*Woody plant/shrub establishment*  
Pattern:  Block  Mosaic  Strips: Width: \_\_\_\_\_  
Acreage or length established annually: \_\_\_\_\_ Spacing: \_\_\_\_\_  
Shrub/tree species used: \_\_\_\_\_  
*Additional Information:* \_\_\_\_\_

*Natural cavity/snag development*  
Species of snag \_\_\_\_\_ Size of snags: \_\_\_\_\_ Number/acre \_\_\_\_\_  
*Additional Information:* \_\_\_\_\_

**7. CENSUS**

*Spotlight counts* Targeted species: \_\_\_\_\_  
Length of route: \_\_\_\_\_ Visibility of route \_\_\_\_\_  
Dates (3 required) A. \_\_\_\_\_ B. \_\_\_\_\_ C. \_\_\_\_\_  
Additional Information: \_\_\_\_\_

*Standardized incidental observations* Targeted species: \_\_\_\_\_  
Observations from:  Feeders  Food plots  Blinds  Vehicle  Other \_\_\_\_\_  
Dates: \_\_\_\_\_  
Additional Information: \_\_\_\_\_

*Stand counts of deer* (5 one hour counts per stand required). Number of stands: \_\_\_\_\_  
Dates: \_\_\_\_\_  
Additional Information: \_\_\_\_\_

*Aerial Counts* Species counted: \_\_\_\_\_  
Type of survey:  Helicopter  Fixed-wing  
Percent of area surveyed:  Total  50%  Other: \_\_\_\_\_  
Additional Information: \_\_\_\_\_

*Track counts:*  Predators  Furbearers  Deer  Other: \_\_\_\_\_  
Additional Information: \_\_\_\_\_

*Daylight deer herd/wildlife composition counts*  
Species:  Deer  Turkey  Dove  Quail  Other \_\_\_\_\_  
Additional Information: \_\_\_\_\_

*Harvest data collection/record keeping:*  Deer  Game birds  
 Age  Weight  Sex  Antler data  Harvest date  
Additional Information: \_\_\_\_\_

*Browse utilization surveys* (thirty 12 foot circular plots required)  
Additional Information: \_\_\_\_\_

*Census of endangered, threatened, or protected wildlife.* Species: \_\_\_\_\_  
Method and dates: \_\_\_\_\_  
Additional Information: \_\_\_\_\_



*Census and monitoring of nongame wildlife species.* Species: \_\_\_\_\_  
 Method and dates: \_\_\_\_\_  
 Additional Information: \_\_\_\_\_

*Miscellaneous Counts:* Species being counted: \_\_\_\_\_

Remote detection (i.e. cameras)     Hahn (walking) line     Roost counts

Booming ground counts     Time/area counts     Songbird transects and counts

Quail call and covey counts     Point counts     Small mammal traps

Drift fences and pitfall traps     Bat departures     Dove call counts

Chachalaca counts     Turkey hen/poult counts     Waterfowl/water bird counts

Alligator nest/census counts     Other: \_\_\_\_\_

Additional Information: \_\_\_\_\_

**IX. Additional Supporting Information. (Optional)**

Attach any other supporting information, such as maps or photographs that you believe to be relevant to this wildlife management plan.

I certify that the above information provided by me in this application is to the best of my knowledge and belief, true and complete.

\_\_\_\_\_  
 Landowner Signature

\_\_\_\_\_  
 Date

This area for use only if the wildlife management plan was prepared for the above landowner for a fee by a wildlife professional or consultant. \*

<b>Signature of person preparing wildlife management plan.</b>	<b>Date</b>
<b>Company</b>	<b>Phone Number</b>
<b>*Signature by TPWD not required for this plan to be lid.</b>	

Texas Parks and Wildlife does not maintain the information collected through this form. This completed form is only provided to the County Tax Appraiser. Please inquire with your County Central Appraisal District on any local laws concerning any information collected through this form.



# 1-D-1 Open Space Agricultural Valuation Wildlife Management Annual Report for the Year(s) \_\_\_\_\_

Submit this plan to your County Tax Appraiser, not to Texas Parks and Wildlife

## Part I. Owner Information

Account Number: \_\_\_\_\_

Owner's Name: \_\_\_\_\_

Current mailing address: \_\_\_\_\_

City, town, post office, state and zip code: \_\_\_\_\_

Phone number: \_\_\_\_\_

Tract Name: \_\_\_\_\_ Majority County: \_\_\_\_\_

Additional Counties (if any): \_\_\_\_\_

## Part II. Qualifying Wildlife Management Activities

**Check the wildlife management practices implemented on the property during the year being reported. A minimum of three practices is required.**

Habitat control

Erosion control

Predator control

Making census counts to determine population.

Provide supplemental supplies of water

Provide supplemental supplies of food

Provide shelters

## Part III. Wildlife Management Association Membership

Are you a member of a wildlife property association?  Yes  No

Name of wildlife property co-op/association, if YES is checked. \_\_\_\_\_

## Part IV. Wildlife Management Activities

Check the activities you have implemented during the year to support each of the wildlife management activities listed in Part II.

### 1. HABITAT CONTROL

- Grazing management.* Check grazing system being utilized.
- 1 herd/3pasture     1 herd/4 pasture     1 herd/multiple pasture
- High intensity/low frequency (HILF)     Short duration system
- Other type of grazing system (describe) \_\_\_\_\_

Additional Information: \_\_\_\_\_

- Prescribed Burning*

Acres to be burned: \_\_\_\_\_ Planned burn date: \_\_\_\_\_

Additional Information: \_\_\_\_\_

- Range Enhancement (Range Reseeding)*

Acres to be seeded: \_\_\_\_\_ Date to be seeded: \_\_\_\_\_

Seeding Method:  Broadcast     Drilled     Native Hay

Seeding mixture to be used: \_\_\_\_\_

Fertilized:  Yes     No

Weed control needed for establishment?  Yes     No

Additional Information: \_\_\_\_\_

- Brush Management.* Acres to be treated: \_\_\_\_\_ Check method of brush management:

Mechanical

grubber     chain     roller chopper/aerator     rhome disc

brush hog (shredder)     dozer     hand-cutting (chainsaw)

hydraulic shears     other (describe): \_\_\_\_\_

Chemical Kind: \_\_\_\_\_ Rate: \_\_\_\_\_

Brush management design:

block     mosaic     strips: width: \_\_\_\_\_ Length: \_\_\_\_\_

Additional Information: \_\_\_\_\_

- Fence Modification*

Target species:  pronghorn antelope     bighorn sheep

Technique:  fold up bottom of net-wire    Gap width: \_\_\_\_\_

replace sections of net-wire with barbed wire. Gap width: \_\_\_\_\_

Miles of fencing that will be modified: \_\_\_\_\_

replace entire net-wire fence with barbed wire. Miles replaced: \_\_\_\_\_

Additional Information: \_\_\_\_\_

*Riparian management and enhancement*

Fencing of riparian area

Complete fencing     Partial fencing

Deferment from livestock grazing

Complete deferment     partial deferment    Season deferred : \_\_\_\_\_

Establish vegetation

Trees (list species) \_\_\_\_\_

Shrubs (list species) \_\_\_\_\_

Herbaceous species (list) \_\_\_\_\_

*Additional Information:* \_\_\_\_\_

*Wetland enhancement*

Provide seasonal water     Provide permanent water     Moist soil management

Other (describe) \_\_\_\_\_

*Additional Information:* \_\_\_\_\_

*Habitat Protection for species of concern*

Fencing     Firebreaks     Prescribed burning     Control of nest parasites

Habitat manipulation (thinning, etc.)     Native/exotic ungulate control

Other (describe) \_\_\_\_\_

*Additional Information:* \_\_\_\_\_

*Prescribed Control of Native, Exotic and Feral Species*

Prescribed control of vegetation     Prescribed control of animal species

Species being controlled: \_\_\_\_\_

Method of control: \_\_\_\_\_

*Additional Information:* \_\_\_\_\_

*Wildlife Restoration*

Habitat restoration     Wildlife restoration

Target species: \_\_\_\_\_

Method of restoration: \_\_\_\_\_

*Additional Information:* \_\_\_\_\_

## 2. EROSION CONTROL

*Pond construction and repair*

Surface area (acres): \_\_\_\_\_ Number of cubic yards of soil displaced: \_\_\_\_\_

Length of dam (feet): \_\_\_\_\_ Planned date of construction: \_\_\_\_\_

*Additional Information:* \_\_\_\_\_

*Gully shaping*

Total acres to be treated: \_\_\_\_\_ Acres treated annually: \_\_\_\_\_

Seeding mix used for reestablishment of vegetation: \_\_\_\_\_

Planned date of construction: \_\_\_\_\_

*Additional Information:* \_\_\_\_\_

*Streamside, pond, and wetland revegetation.* Techniques used:

Native hay bales  Fencing  Filter strips  Seeding upland buffer

Rip-rap, etc.  stream crossings  Other: \_\_\_\_\_

Planned date of construction: \_\_\_\_\_

*Additional Information:* \_\_\_\_\_

*Herbaceous and/or woody plant establishment on critical areas (erodible)*

Establish windbreak  Establish shrub mottes  Improve plant diversity

Improve wildlife habitat  Conservation/no-till practices  Manage CRP cover

*Additional Information:* \_\_\_\_\_

*Dike/Levee Construction/Management*

Reshaping/repairing erosion damage  Revegetating/stabilize levee areas

Install water control structure  Fencing

*Additional Information:* \_\_\_\_\_

*Establish water diversion*

Type:  Channel  Ridge

Slope:  level  graded Length (feet) \_\_\_\_\_

Vegetated:  No  YES

If YES:  Native: \_\_\_\_\_  Crop: \_\_\_\_\_

*Additional Information:* \_\_\_\_\_

### 3. PREDATOR CONTROL

Imported red fire ants (verify prior to application that product is labeled for pasture use)

Control of cowbirds       Grackle/starling/house sparrow control

Method of control:  Trapping    Shooting    Baiting    Scare tactics \_\_\_\_\_

Coyotes    Feral hogs    Raccoon    Skunk    Bobcat    Mountain lion

Rat snakes    Feral cats/dogs

Method of control:  Trapping    Shooting                       M-44 (licensed applicators)

Poison collars (1080 certified, licensed, applicator)    Other \_\_\_\_\_

Additional Information: \_\_\_\_\_

### 4. SUPPLEMENTAL WATER

*Marsh/Wetland Restoration or Development*

Greentree reservoirs    Shallow roost pond development    Seasonally flooded crops

Artificially created wetlands       Marsh restoration/development/protection

Prairie pothole restoration/development/protection    Moist soil management units

Planned date of construction: \_\_\_\_\_

Additional Information: \_\_\_\_\_

*Well/trough/windmill overflow/other wildlife watering facilities*

Drill new well    Depth: \_\_\_\_\_    Gallons per minute: \_\_\_\_\_

Windmill    Pump    Pipeline:   Size \_\_\_\_\_   Length: \_\_\_\_\_

Modification(s) of existing water source

Fencing    Overflow    Trough modification    Pipeline

Distance between water sources (waterers): \_\_\_\_\_

Type of wildlife watering facility

PVC pipe facility                      # \_\_\_\_\_                       Drum with faucet or float                      # \_\_\_\_\_

Small game guzzler                      # \_\_\_\_\_                       Windmill supply pipe dripper                      # \_\_\_\_\_

Plastic container                      # \_\_\_\_\_                       In-ground bowl trough                      # \_\_\_\_\_

Big game guzzler                      # \_\_\_\_\_                       Inverted umbrella guzzler                      # \_\_\_\_\_

Flying saucer guzzler                      # \_\_\_\_\_                       Ranch Specialties guzzler                      # \_\_\_\_\_

Other: \_\_\_\_\_

Additional Information: \_\_\_\_\_

*Spring development and/or enhancement*

Fencing    Water diversion/pipeline    Brush removal    Spring clean out

Other: \_\_\_\_\_

Additional Information: \_\_\_\_\_

## 5. PROVIDING SUPPLEMENTAL FOOD

Grazing management       Prescribed burning       Range enhancement

Food plots      Size: \_\_\_\_\_ Fenced:  Yes     No

Irrigated:     Yes       No

Plantings:     Cool season annual crops: \_\_\_\_\_

Warm season annual crops: \_\_\_\_\_

Annual mix of native plants: \_\_\_\_\_

perennial mix of native plants: \_\_\_\_\_

*Additional Information:* \_\_\_\_\_

*Feeders and mineral supplementation*

Purpose:     Supplementation       Harvesting of wildlife

Targeted wildlife species: \_\_\_\_\_

Feed type: \_\_\_\_\_ Mineral type: \_\_\_\_\_

Feeder type: \_\_\_\_\_ Number of feeders: \_\_\_\_\_

Method of mineral dispensing: \_\_\_\_\_

Number of mineral locations: \_\_\_\_\_

Year round:  Yes     No      If not, state when: \_\_\_\_\_

*Additional Information:* \_\_\_\_\_

*Managing tame pasture, old fields and croplands*

Overseeding cool and/or warm season legumes and/or small grains

Periodic disturbance (Discing/Mowing/Shredding)     Conservation/no-till

*Additional Information:* \_\_\_\_\_

*Transition management of tame grass monocultures*

Overseed 25% of tame grass pastures with locally adapted legumes

Species planted:     Clover     Peas     Vetch     Other: \_\_\_\_\_

*Additional Information:* \_\_\_\_\_

**6. PROVIDING SUPPLEMENTAL SHELTER**

Nest boxes Target Species: \_\_\_\_\_

Cavity type. # \_\_\_\_\_  Bat boxes. # \_\_\_\_\_  Raptor pole. # \_\_\_\_\_

Additional Information: \_\_\_\_\_

Brush piles and slash retention

Type:  Slash  Brush piles Number per acre: \_\_\_\_\_

Additional Information: \_\_\_\_\_

Fence line management Length: \_\_\_\_\_ Initial establishment:  Yes  No

Plant type established:  Trees  Shrubs  Forbs  Grasses

Additional Information: \_\_\_\_\_

Hay meadow, pasture and cropland management for wildlife Acres treated: \_\_\_\_\_

Shelter establishment:  Roadside management  Terrace/wind breaks  Field borders

shelterbelts  Conservation Reserve Program lands management

Type of vegetation:  Annual  Perennial

Species and percent of mixture \_\_\_\_\_

Deferred mowing Period of deferment: \_\_\_\_\_

Mowing Acres mowed annually: \_\_\_\_\_

No till/minimum till

Additional Information: \_\_\_\_\_

Half-cutting trees or shrubs

Acreage to be treated annually: \_\_\_\_\_ Number of half-cuts annually: \_\_\_\_\_

Additional Information: \_\_\_\_\_

Woody plant/shrub establishment

Pattern:  Block  Mosaic  Strips: Width: \_\_\_\_\_

Acreage or length established annually: \_\_\_\_\_ Spacing: \_\_\_\_\_

Shrub/tree species used: \_\_\_\_\_

Additional Information: \_\_\_\_\_

Natural cavity/snag development

Species of snag \_\_\_\_\_ Size of snags: \_\_\_\_\_ Number/acre \_\_\_\_\_

Additional Information: \_\_\_\_\_



## 7. CENSUS

*Spotlight counts* Targeted species: \_\_\_\_\_  
Length of route: \_\_\_\_\_ Visibility of route \_\_\_\_\_  
Dates (3 required) A. \_\_\_\_\_ B. \_\_\_\_\_ C. \_\_\_\_\_  
Additional Information: \_\_\_\_\_

*Standardized incidental observations* Targeted species: \_\_\_\_\_  
Observations from:  Feeders  Food plots  Blinds  Vehicle  Other \_\_\_\_\_  
Dates: \_\_\_\_\_  
Additional Information: \_\_\_\_\_

*Stand counts of deer* (5 one hour counts per stand required). Number of stands: \_\_\_\_\_  
Dates: \_\_\_\_\_  
Additional Information: \_\_\_\_\_

*Aerial Counts* Species counted: \_\_\_\_\_  
Type of survey:  Helicopter  Fixed-wing  
Percent of area surveyed:  Total  50%  Other: \_\_\_\_\_  
Additional Information: \_\_\_\_\_

*Track counts:*  Predators  Furbearers  Deer  Other: \_\_\_\_\_  
Additional Information: \_\_\_\_\_

*Daylight deer herd/wildlife composition counts*  
Species:  Deer  Turkey  Dove  Quail  Other \_\_\_\_\_  
Additional Information: \_\_\_\_\_

*Harvest data collection/record keeping:*  Deer  Game birds  
 Age  Weight  Sex  Antler data  Harvest date  
Additional Information: \_\_\_\_\_

*Browse utilization surveys* (thirty 12 foot circular plots required)  
Additional Information: \_\_\_\_\_

*Census of endangered, threatened, or protected wildlife.* Species: \_\_\_\_\_  
Method and dates: \_\_\_\_\_  
Additional Information: \_\_\_\_\_

*Census and monitoring of nongame wildlife species.* Species: \_\_\_\_\_  
Method and dates: \_\_\_\_\_  
Additional Information: \_\_\_\_\_

*Miscellaneous Counts:* Species being counted: \_\_\_\_\_

Remote detection (i.e. cameras)       Hahn (walking) line       Roost counts

Booming ground counts       Time/area counts       Songbird transects and counts

Quail call and covey counts       Point counts       Small mammal traps

Drift fences and pitfall traps       Bat departures       Dove call counts

Chachalaca counts       Turkey hen/poult counts       Waterfowl/water bird counts

Alligator nest/census counts       Other: \_\_\_\_\_

*Additional Information:* \_\_\_\_\_

**Part V. Attach copies of supporting documentation such as receipts, maps, photos, etc. Use additional pages if necessary.**

I certify that the above information provided by me is to the best of my knowledge and belief true and complete.

\_\_\_\_\_  
Signature

\_\_\_\_\_  
Date

Texas Parks and Wildlife does not maintain the information collected through this form. This completed form is only provided to the County Tax Appraiser. Please inquire with your County Central Appraisal District on any local laws concerning any information collected through this form.

## References

### Literature:

Refer to the following Texas Parks and Wildlife Department (TPWD) and Texas Agricultural Extension Service (TCE) bulletins and pamphlets for additional habitat management and specific species management information:

### Habitat:

Prescribed Range Burning in Texas by L.D. White and C. W. Hanselka, TAEX, Reprinted by TPWD, # PWD-BK-7100-196-7/91

Prescribed Burning Juniper Communities in Texas, by G. Rasmussen, G. McPherson, and H. Wright, Texas Tech Management Note No. 10, 1986.

Management of Tobosagrass Rangeland with Prescribed Fire, by C. Britton, H. Wright, B. Dahl, and D. Ueckert, Texas Tech Management Note No. 12, 1987.

Sand Shinnery Oak: Control and Management, by R. Pettit, Texas Tech Management Note No. 8, 1986.

Managing Playas for Wildlife in the Southern High Plains of Texas, by F. Guthery and F. Stormer, Texas Tech Management Note No. 4, 1984.

Vegetation Management in Playa Lakes for Wintering Waterfowl, by D. Haukos and L. Smith, Texas Tech Management Note No. 14, 1991.

Wildlife Habitat Management on Former CRP Lands, by S. Lutz, G. Valentine, S. Nelle, D. Rollins, C. Coffman, and G. Miller, Texas Tech Management Note No. 15, 1994.

Wetlands Assistance Guide for Landowners by J. K. Anderson, TPWD, #PWD BK R2000-020 (7/95)

### White-tailed Deer:

Basics of Brush Management for White-tailed Deer Production by Tommy L. Hailey, #PWD-BK-7100-35-12/88

Learn About Whitetails by R. L. Cook, # PWD-BK-N7100-7-2/93

Determining the Age Of a Deer by C. W. Ramsey, D. W. Steinbach, D. W. Rideout , TAEX #B-1453

Supplemental Feeding by J. R. Perkins, TPWD, #PWD-BK-N7100-033-11/91

### Desert Mule Deer:

New Desert Mule Deer Management pamphlet by Cantu and Richardson, #PWD-BK-W7100-303(9/97)

West Texas Mule Deer, by Tim Bone and Bill Russ, #PWD-BK-7100-199-4/92

Managing Desert Mule Deer, by D. Rollins, TAEX #B-1636

Managing Plains Mule Deer in Texas and Eastern New Mexico, by F. Bryant and B. Morrison, Texas Tech Management Note No. 7 1985.

#### Pronghorns:

Texas Pronghorns, by D. Swepston and T. Hailey, #PWD-BK-7100-46-10/91

#### Quail:

Quail Management Handbook for West Texas Rolling Plains, by A.S. Jackson, TPWD Bulletin # 48

The 182 page book "Beef, Brush and Bobwhites - Quail Management in Cattle Country" by Fred S. Guthery. Published by the Caesar Kleberg Wildlife Research Institute, Texas A&I University (now Texas A&M at Kingsville), Kingsville, Texas in 1986.

#### Lesser Prairie Chicken:

The Lesser Prairie Chicken and Its Management in Texas, by G. Litton, R. West, D. Dvorak, and G. Miller, #PWD-BK-N7100-025 (5/94)

#### Dove:

Mourning Doves in Texas, Life History, Habitat Needs, and Management Suggestions by R. R. George, TPWD, #PWD-BK-7100-009A-3/88

#### Turkey:

Rio Grande Turkey Habitat Management by G. W. Litton and F. Harwel, TPWD, # PWD RP W7100-263 (10/95)

#### Feral Hog:

The Feral Hog in Texas by R. Taylor, TPWD, #PWD-BK-7100-195-10/91

#### Purple Martin:

The Purple Martin and Its Management in Texas by J. D. Ray, TPWD, # PWD BK W7100-254 (04/95)

## APPENDIX Y

### The High Plains

Described as a sea of waving grasslands, the High Plains extends from the Panhandle south to the Pecos River. This 20,000,000-acre region fills most of the "handle portion" of the state and consists of a relatively high and level plateau of sandy to heavy, dark, calcareous clay soils lying over an impervious layer of caliche. Soils consist mainly of outwash sediments from the Rocky Mountains. Elevations range from 3,000 to 4,700 feet, with an average annual temperature of approximately 59° F. Winters here are the coldest in Texas. Rainfall averages from 21 inches on the eastern edge of the region to as low as 12 on the southwestern edge. Sun and wind rob the soil of what little moisture it receives. Today, an arid, treeless plain, much of the High Plains is irrigated from the vast Ogallala formation. Classified as mixed-prairie and short-grass prairie, the vegetation varies as a function of location. Hardlands, mixed lands, sandy lands, draws or caliche lakes give rise to distinct differences in plant communities (Correll and Johnston, 1979). Though characteristically free from trees or brush, honey mesquite and yucca have invaded some areas, while sandsage and shinnery oak have spread through the sandylands. Playa lakes play an essential role in this region, as they are among the prime waterfowl wintering grounds for the North American Central Flyway. The region's other name, Llano Estacado or "Staked Plains" is thought to derive from the first European settlers to traverse the High Plains who drove stakes into the ground to help guide them across the flat, featureless plain. These early pioneers found a vast carpet of short grasses, home to enormous herds of buffalo and pronghorn antelope. This was also home to the Comanches, "Lords of the South Plains." While the original character of the High Plains has been forever changed by the plow and the barbed wire fence, unique areas still remain, including scattered sand dunes cloaked with Havard shin-oak, sandsage, and little bluestem. Tallgrass meadows still wave in the breezes along the Canadian River and its tributaries, nourished by underground water flowing through the sands. While few rivers actually cross the High Plains, the thin ribbons of meager water along the Canadian and Red Rivers once sustained luxuriant growths of tall willows and cottonwoods. Now two Old World exotic plants, Russian olive and tamarisk, have supplanted the native trees that line the banks, providing alternate homes for versatile phoebes and kingbirds. Grasses still provide cover and nesting habitat for myriads of other birds, and belts of trees planted back in the 1930's provide shelter to an amazing diversity of wildlife. Whereas Gray Wolves, Grizzly Bears and Elk no longer occur on the High Plains, Mountain lions, the adaptable Coyote, Red-tailed Hawk, and the diminutive Swift Fox now sit at the top of the food chain. And while the once vast populations of prairie dogs have dwindled, flocks of wintering waterfowl still frequent the ephemeral playa lakes, as do Sandhill Cranes and shorebirds that forage along the playa margins. Scattered bunches of Lesser Prairie-Chickens still boom on the prairies, though their numbers are greatly reduced, while migrating flocks of Lark Buntings and Horned Larks still ply the skies over restless grassland seas.

## TEXAS WILDSAPES NATIVE PLANT TABLES BIBLIOGRAPHY - HIGH PLAINS

The following references were used to compile the above tables and regional description of the High Plains:

- Ajilvsgi, G. 1984. Wildflowers of Texas. Bryan, Texas: Shearer Publishing Inc.
- Ajilvsgi, G. 1991. Butterfly Gardening for the South. Dallas, Texas: Taylor Publishing Company.
- Correll, D. and M. Johnston. 1979. Manual of the Vascular Plants of Texas. Richardson, Texas: University of Texas.
- Cox, P. and P. Leslie. 1988. Texas Trees; A Friendly Guide. San Antonio, Texas: Corona Press.
- Flores, D.L. 1990. Caprock Canyonlands: Journeys into the Heart of the Southern Plains. Austin, Texas: University of Texas Press.
- Gould, F. 1975. The Grasses of Texas. College Station, Texas: Texas A&M University Press.
- Gould, F., G.O. Hoffman, and C.A. Rechenhain. 1960. Vegetational Areas of Texas. College Station, Texas: Texas Agricultural Experiment Station L-492.
- Great Plains Flora Association. 1977. Atlas of the Flora of the Great Plains. Ames, Iowa: Iowa State University Press.
- Kirkpatrick, Z.M. 1992. Wildflowers of the Western Plains. Austin, Texas: University of Texas Press.
- Martin, A.C., H.S. Zim, and A.L. Nelson. 1951. American Wildlife and Plants - A Guide to Wildlife Food Habits. New York: Dover Publications.
- Mahler, W.F. 1988. Shinner's Manual of the North Central Texas Flora. Fort Worth, Texas: Botanical Research Institute of Texas.
- Nixon, E. 1985. Trees, Shrubs, and Woody Vines of East Texas. Nacogdoches, Texas: Bruce Lyndon Cunningham Productions.
- Peterson, R.T. et al. 1974. Gardening with Wildlife. Washington, D.C.: National Wildlife Federation.
- Rose, F. and R. Strandtmann. 1986. Wildflowers of the Llano Estacado. Dallas, Texas: Taylor Publishing Company.
- Simpson, B.J. 1989. A Field Guide to Texas Trees. Austin, Texas: Texas Monthly Press.
- Texas General Land Office. 1980. "The Natural Heritage of Texas." Austin, Texas: Nature Conservancy.
- Vines, R.A. 1982. Trees of North Texas. Austin, Texas: University of Texas Press.
- Vines, R.A. 1960. Trees, Shrubs, and Woody Vines of the Southwest. Austin, Texas: University of Texas Press.
- Wasowski, S. and A. Wasowski. 1989. Native Texas Plants: Landscaping Region by Region. Austin, Texas: Texas Monthly Press.
- Wilson, J. 1991. Landscaping with Wildflowers. Boston: Houghton Mifflin Company.
- Winckler, S. 1982. Texas Diversity: From the Piney Woods to the Trans-Pecos. In: The Nature Conservancy News: 32(5)

## The Rolling Plains

Marking the southern end of the Great Plains of the central United States, the Rolling Plains represents the "last gasp" of a great continental prairie ecosystem. As its name suggests, topography of the Rolling Plains is gently rolling to moderately rough, with elevations ranging from 800 to 3,000 feet. Rainfall averages between 30 inches in the east to 22 inches in the west (Correll and Johnston, 1979). The average annual temperatures range from 60° F to 64° F. Most of the soils are neutral to slightly basic. Named for the soils, the land is a varied and beautiful assortment of reds, from burnt sienna to the palest of pinks (Wasowski, 1984). East of the Cap Rock, on heavier clay soils, the native prairies of the Rolling Plains consisted of midgrass and tallgrass communities nurtured by the intense summer rains and hot summer days. Pristine pockets of prairie are a rarity today, however. Much of what was once a sweeping expanse of sideoats grama, little bluestem and blue grama has been tilled for grain fields or cotton. In many areas, overgrazing has allowed honey mesquite and shinny oak to spread into the prairies, along with snakeweed and prickly-pear. Trees occurring along waterways and canyons of the Caprock include plains cottonwood, Mohr oak, netleaf hackberry, one-seed juniper, and Rocky Mountain juniper.

The gently rolling hills and broad flats of the Rolling Plains are the birthplace of many great Texas rivers, including the Canadian, the Colorado, the Concho and the Red River which originate in the breaks of the Cap Rock Escarpment and in the western reaches of the region. These rivers and their tributaries harbor their own unique inhabitants such as the Concho Water Snake and Brazos water snake which live only in a few restricted areas of the Colorado and Brazos river systems respectively. Sand bars in the upper reaches of these rivers provide nesting habitat for the rare Interior Least Tern and the Snowy Plover. Juniper woodlands, on the steep breaks of the canyons, are home to the Palo Duro Mouse, a close relative of the Pinyon Mouse of the Rocky Mountains. Burrowing at the base of mesquite trees as they forage by night for seeds and greens, the Texas Kangaroo Rat is restricted to certain clay-loam soils of the Rolling Plains (Texas General Land Office, 1982). This unique desert-adapted rodent still has scientists guessing as to its origins.

## TEXAS WILDSCAPES NATIVE PLANT TABLES BIBLIOGRAPHY - ROLLING PLAINS

The following references were used to compile the above tables and regional description of the Rolling Plains:

- Ajilvsgi, G. 1984. Wildflowers of Texas. Bryan, Texas: Shearer Publishing Inc.
- Ajilvsgi, G. 1991. Butterfly Gardening for the South. Dallas, Texas: Taylor Publishing Company.
- Correll, D. and M. Johnston. 1979. Manual of the Vascular Plants of Texas. Richardson, Texas: University of Texas.
- Cox, P. and P. Leslie. 1988. Texas Trees; A Friendly Guide. San Antonio, Texas: Corona Press.
- Flores, D.L. 1990. Caprock Canyonlands: Journeys into the Heart of the Southern Plains. Austin, Texas: University of Texas Press.
- Gould, F. 1975. The Grasses of Texas. College Station, Texas: Texas A&M University Press.
- Gould, F., G.O. Hoffman, and C.A. Rechenhain. 1960. Vegetational Areas of Texas. College Station, Texas: Texas Agricultural Experiment Station L-492.
- Great Plains Flora Association. 1977. Atlas of the Flora of the Great Plains. Ames, Iowa: Iowa State University Press.
- Kirkpatrick, Z.M. 1992. Wildflowers of the Western Plains. Austin, Texas: University of Texas Press.
- Martin, A.C., H.S. Zim, and A.L. Nelson. 1951. American Wildlife and Plants - A Guide to Wildlife Food Habits. New York: Dover Publications.
- Peterson, R.T. et al. 1974. Gardening with Wildlife. Washington, D.C.: National Wildlife Federation.
- Rose, F. and R. Strandtmann. 1986. Wildflowers of the Llano Estacado. Dallas, Texas: Taylor Publishing Company.
- Simpson, B.J. 1989. A Field Guide to Texas Trees. Austin, Texas: Texas Monthly Press.
- Texas General Land Office. 1980. "The Natural Heritage of Texas." Austin, Texas: Nature Conservancy.
- Vines, R.A. 1982. Trees of North Texas. Austin, Texas: University of Texas Press.
- Vines, R.A. 1960. Trees, Shrubs, and Woody Vines of the Southwest. Austin, Texas: University of Texas Press.
- Wasowski, S. and A. Wasowski. 1989. Native Texas Plants: Landscaping Region by Region. Austin, Texas: Texas Monthly Press.
- Wilson, J. 1991. Landscaping with Wildflowers. Boston: Houghton Mifflin Company.
- Winckler, S. 1982. Texas Diversity: From the Piney Woods to the Trans-Pecos. In: The Nature Conservancy News: 32(5)



# Wildscapes Plant Tables -- High Plains

SPECIES	FAMILY	HABIT HEIGHT	FLOWER	FRUIT	SUN EXPOSURE	HABITAT	SOILS & MOISTURE REGIME	VEGETATION ZONE										ORNAMENTAL VALUE	WILDLIFE VALUE
								1	2	3	4	5	6	7	8	9	10		
<i>Celtis laevigata</i> Sugarberry	Ulmaceae - Elm Family	Tree, large 40' - 60'	inconspicuous, small, greenish. May - June	Berry (drupe), orange-red to purplish-black. July - Aug.	Full sun, part shade	Rocky or alluvial soils along streams, in woodlands & thickets.	Sands, loams, and clays. Prefers rich soils, but will tolerate wide range Well-drained, mesic to xeric; drought tolerant once established.	X	X	X	X	X	X	X	X	X	X	Fast-growing shade tree adapted to most soils. Very drought tolerant. Yellow autumn color. Deciduous.	Fruit eaten by bluebirds, robins, cardinals, mockingbirds, cedar waxwings, thrashers, & sparrows. Good nest & cover tree, esp. for neotropical migrants. Larval food plant for Question Mark, Mourning Cloak, Pale Emperor, Snout & Hackberry butterflies.
<i>Populus sargentii</i> Plains cottonwood	Salicaceae - Willow family	Tree, large 50' - 60'	inconspicuous, yellow m & f catkins. March - June	Capsule with oblong seeds. June - Aug.	Full sun, part shade	Prefers sandy alluvial soils along rivers & streams, near stock tanks & along roadside banks.	Sands, sandy loams. Well-drained, mesic					X			X	X	X	Plains cottonwood provides good shade. Branches are erect & spreading to form a broad crown. Attractive shiny yellowish green leaves flutter in the wind. Deciduous.	Good nesting & cover tree for birds. Foliage is browsed by deer & cotton-tail rabbit. The seeds are eaten by several species of birds.
<i>Prosopis glandulosa</i> Honey mesquite	Leguminosae Legume Family	Tree, large 20' - 30'	Showy creamy yellow elongated spike-like racemes. May - Sept.	Legumes in loose clusters. August - Sept.	Full sun, part shade	Tolerates wide range of situations, open fields, edges of woodlands, etc.	Sands, loams & clays Well-drained, xeric	X	X	X	X	X	X	X	X	X	X	Attractive tree with crooked, drooping branches, feathery leaves & rounded crown. Fast growing & often shrubby, forming thickets. Fixes nitrogen in the soil. Deciduous.	Good nectar plant for bees & other insects. Many species of wildlife like quail, bobwhite, doves depend on it for food & shelter from the sun. Squirrels, coyotes, skunks, rabbits & deer eat pods. LHP for Long-tailed skipper & Reickert's blue.
<i>Quercus macrocarpa</i> Bur oak	Fagaceae - Beech Family	Tree, large 60' - 80'	inconspicuous m & f catkins, red & greenish March - April	Acorns Sept. - Oct.	Full sun, part shade	Prefers moist forests along streams & in fallow fields.	Sands, loams & clays. Well-drained, mesic	X	X	X	X			X	X			Very graceful shade tree, widely adaptive, fast-growing for an oak. Attractive leaves, unusual acorn, drought resistant & long-lived. Not native to High Plains, but would do well there. Deciduous.	Important source of food for several species of birds, woodpeckers, jays, game birds. Also sought after by mammals, white-tailed deer, squirrels & raccoons. Good substrate for insectivorous birds. Larval host plant for Sleepy & Juvenal's Duskywing.
<i>Salix amygdaloides</i> Peach-leaf willow	Salicaceae - Willow Family	Tree, large 30' - 40'	m & f creamy yellowish-green catkins, on separate trees. April - May	Capsules, borne on catkins reddish-yellow with many seeds. May	Full sun, part shade	Prefers areas around water ways whether wet or dry, ponds or any other water-holding	Sand, loams & clays; limestone soils. Well-drained but moist.							X	X	X		A striking willow with yellow twigs, green peach-leaf shaped leaves that are attractively silvery white underneath. Tree has drooping branches. Rapid-growing but not long-lived. Deciduous.	Catkins provide food & nesting material for many forms of wildlife. Good substrate for insectivorous birds. Allows light underneath the tree for other things to grow. LHP for Mourning Cloak.

				- June		depression.												
<i>Sapindus drummondii</i> Western soapberry	Sapindaceae Soapberry family	Tree, large 15' - 50'	clusters of small white flowers. May - June	Round, amber, wrinkled berry-like fruit with 1 seed. Sept. - Oct.	Full sun, part shade	Prefers moist soils along streams & fencerows, scattered throughout Texas.	Sands, loams & clays, likes limestone soils. Well-drained, mesic.	X	X	X	X	X	X	X	X	X	Fine-looking shade tree with dependable yellow fall foliage. Translucent amber fruits have white seeds which are poisonous to us. Moderately fast growing; also tolerates poor sites. Forms thickets but does not live long. Deciduous.	Fruit highly prized by many kinds of birds that are not affected by poison. Bluebirds, robins, cedar waxwings devour them. Small flowers provide nectar to various insects. Good nest & cover tree. Substrate to insectivores. LHP to Soapberry hairstreak.
<i>Celtis reticulata</i> Net-leaf hackberry	Ulmaceae - Elm Family	Tree, medium to small 15' - 30'	inconspicuous greenish flowers, small & perfect. May - June	Drupe, orange-red. Aug. - Sept.	Full sun, part shade	Prefers wooded limestone slopes. Mostly restricted to North Central, Central & parts of South Texas.	Sands, loams, & clays. Likes limestone & caliche-type soils. Well-drained, mesic-xeric.	X	X	X	X	X	X	X	X	X	Can grow to be a shade tree with thickish rough-surfaced leaves with net-like veins on undersurface. Trees are strongly taprooted & extremely drought-tolerant. Deciduous.	Fleshy fruits persist on this tree in the winter making it a valuable food source for all kinds of birds: robins, cedar waxwings, bluebirds, cardinals, finches & sparrows. Fine substrate for insectivorous birds. LHP for hackberry, snout & ? butterflies.
<i>Cercocarpus montanus</i> v. <i>argenteus</i> Silver-leaf mountain mahogany	Rosaceae - Rose Family	Tree, small 12' - 15'	White to yellowish flowers. March - April, further north, June - July	Fruit, slim, leathery, brown & plume-tipped. May - Nov.	Full sun, part shade	Prefers rocky slopes & canyons in Edwards Plateau, Trans-Pecos & Panhandle.	Sands, loams & clays, & caliche type soils, alkaline to neutral. Well-drained, xeric					X	X	X	X	X	A small persistent to evergreen tree with dark green leathery leaves with dense woolly-white undersides. Very ornamental. Is most beautiful in the late summer & fall when feather-like fruits mature. Slow to moderate grower; drought-tolerant. Persistent.	While birds may use silky plumed fruit to line nests, not much fruit is eaten. White-tailed deer browse on leaves with enthusiasm.
<i>Morus microphylla</i> Texas mulberry	Moraceae Fig Family	Tree, small 10' - 25'	Small green to red inconspicuous ament-like spikes. March - April	Mulberries red to black, 1-seeded drupes in syncarp. May - June	Full sun, part shade	Prefers canyons, limestone & igneous slopes in western 2/3rds of Texas.	Sands, loams, clays, caliche-type & limestone soils. Well-drained, xeric	X	X	X	X	X	X	X	X	X	A small shaggy tree more often shrub with rough, sand-papery leaves & small fruits. Very drought-tolerant once established. Deciduous.	Texas mulberry makes a good cover & nesting shrub. Several species of game & song birds, as well as opossum, raccoons & squirrels relish the ripe mulberries. Quail, mourning doves & cardinals are especially fond of them. Deer often browse the leaves.

<i>Quercus mohriana</i> Mohr oak	Fagaceae - Beech Family	Tree, small 10' - 20'	inconspicuous m & female catkins, reddish. April - May	Acorns, reddish brown, every year. Sept. - Nov.	Full sun, part shade	Prefers limestone hills & mountains, also grasslands, igneous slopes in West & West Central Texas. Often shrubby, creating mottes in the Rolling Plains & western Edwards Plateau.	Sands, loams, hard limestone, exposed caliche like soils. Well-drained, xeric.				X	X	X	X	One of the few oaks of the midgrass to shortgrass prairies. A small, round-topped evergreen oak with dark green to gray green leaves with wavy edges & furry white underside. Forms thickets, is drought tolerant & fire resistant. Persistent to evergreen.	Mohr oak is an excellent nesting & protective cover for birds & small mammals. Catkins eaten by several species of birds. Acorns eaten & cached by several kinds of birds & mammals. Good substrate for insectivorous birds.	
<i>Rhus lanceolata</i> Lance-leaf sumac	Anacardiaceae Sumac Family	Tree, small 10' - 20'	m & f flowers, small greenish white, on separate trees June	Drupes, small red, in clusters, remain after leaves fall. Sept. - Dec.	Full sun, part shade	Occurs on limestone & in calcareous soils, woodlands & roadside edges, along fencerows. Tolerates disturbed soils.	Sands, sandy loams, neutral clays, likes limestone soils. Well-drained, mesic	X	X			X		X	Sometimes thicket-forming small tree with elegant compound leaves & showy red fruit clusters. Only trees with f flowers have fruit. Beautiful red color in fall. Fast growing with a very attractive shape. Not native to High Plains, but grows well here.	Fruit is eaten by more than 20 species of birds, favored by quail & turkey. Flowers attract numerous insects in spring, good nectar source for bees & butterflies. Leaves browsed by deer. Larval host plant for Red-banded hairstreak.	
<i>Acacia greggii</i> Gregg acacia	Leguminosae Legume Family	Ornamental small tree 5' - 9'	Showy creamy-yellow spikes with exerted stamens. April - Oct., shorter bloom time further north.	Legume, light brown to reddish, persistent. July - Dec.	Full sun, part shade	Prefers chaparral & brushy areas in Rio Grande Plains, Trans Pecos & parts of Rolling Plains.	Sands, loams, clays, caliche type & limestone soils. Well-drained, xeric.	X				X	X	X	X	Thorny, thicket-forming, round-topped shrub or small tree with delicate compound leaves & creamy yellow flowers. Can form impenetrable thickets in shrub form. Not native to High Plains but will grow there. Deciduous.	Gregg acacia furnishes cover & shelter for small animals. Flowers attract myriads of insects. Seeds are eaten by bobwhite & scaled quail. White-tailed deer browse foliage. Pollen important bee food. Good honey plant.
<i>Cercis canadensis v. texensis</i> Texas redbud	Leguminosae Legume Family	Ornamental small tree 10' - 30'	Showy magenta pea-like flowers. March, before leaves.	Legumes, brownish-red, in clusters. Sept.	Full sun, part shade, dappled shade	Prefers thinner calcareous, rocky soils of Edwards Plateau & North Central Texas. Not native but will grow in High Plains.	Sands, loams & clays; likes limestone soils. Well-drained, mesic; but less moisture than Eastern variety.	X	X			X	X		Highly ornamental and showy small tree with spreading, flat or rounded crown. Good understory tree or accent plant. Fast growing, usually with single trunk. Leaves have distinctive kidney shape & are shinier than other subspecies of Redbud. Deciduous.	Beautiful magenta flowers are copious early nectar source for butterflies, moths, bees, etc. Seeds are eaten by a number of species of birds; foliage browsed by white-tailed deer. Larval host plant to Henry's Elfin.	
<i>Prunus gracilis</i> Oklahoma plum	Rosaceae - Rose Family	Ornamental shrub 2' - 6'	Showy white flowers, fragrant. March - April	Plums, red with oval stone. July - Aug.	Full sun, part shade, dappled shade	Prefers open hills & their woods from East Texas to Panhandle, along fencerows and edges of fields.	Sands. Well-drained, xeric to mesic.	X	X	X	X			X	X	Beautiful thicket plum with ravishing spring white fragrant flowers that appear before the leaves. Deciduous.	Oklahoma plum flowers attract several kinds of insects, especially bees & butterflies. Several species of birds and small mammals relish the plums.

<i>Prunus virginiana</i> Common chokecherry	Rosaceae - Rose Family	Ornamental small tree or shrub 15' - 30'	Showy, short dense racemes of white flowers, fragrant. April - July	Choke cherries luscious scarlet to purple black. July - Sept.	Full sun, part shade, dappled shade	Prefers open woods, rocky slopes, bluffs, rimrock, breaks & seepage areas.	Sands, loams, clays & limestone soils. Well-drained, mesic	X			X	X	X	X	X	X	Large ornamental understory shrub to small tree with erect or horizontal branches, racemes of white fragrant flowers, red to black chokecherries. This is a good erosion control plant. Deciduous.	Flowers attract hordes of insects of all kinds. Fruit eaten by at least 40 species of birds. Leaves browsed by cotton-tail & deer. LHP for Tiger swallowtail, Striped hairstreak, Coral hairstreak, Red-spotted purple & Spring azure.
<i>Pyrus ioensis</i> Prairie crabapple	Rosaceae - Rose Family	Ornamental small tree 10' - 15'	Showy white or salmon pink-petalled blossoms. Feb. - April	Crab apple (pome.) Aug. - Oct.	Full sun, part shade	Prefers stream banks & heads of canyons, limestone slopes & draws.	Sands, loams, clays & limestone soils. Well-drained, mesic					X	X				While Prairie crabapple is not native to the High Plains, it would grow well there with proper treatment. It has lovely flowers in the spring & would make a nice accent plant. In the wild the tree is rare. Deciduous.	All kinds of insects are attracted to the spring blossoms, especially bees & butterflies. Approximately 20 species of wildlife, both birds & small mammals, enjoy the small crab apples.
<i>Juniperus monosperma</i> One-seed juniper	Cupressaceae Cypress Family	Conifer 15' - 50'	inconspicuous, dioecious, m & f, very small. March - April	Cones, fleshy round dark blue to brownish on f tree. Sept. - Oct.	Full sun, part shade	Prefers steep slopes, broken ground about rim rock & breaks, eroded soils of arroyos & plains & in brushlands.	Sands, loams, clays, caliche-type & limestone soils. Well-drained, xeric.					X	X	X			Evergreen small tree with shrubby aspect, often with several small trunks forming low, open bush-like crown. Extremely cold-hardy & drought-tolerant. Will grow rapidly but needs pruning to get character. Only female plant has berries. Hates heat.	Excellent protective cover & nesting substrate. Blue-black fruit savored by quail, raccoons, rock squirrels & several song birds. Larval host plant for several species of hairstreak butterflies.
<i>Juniperus scopulorum</i> Rocky Mountain juniper	Cupressaceae Cypress Family	Conifer 20' - 36'	inconspicuous, small yellowish m & f cones. April - May	Bluish berry-like fruit takes 2 years to ripen. Nov. - Dec.	Full sun, part shade	Prefers rocky areas in canyons & on breaks in Trans Pecos Guadalupe Mountains & Northern Plains.	Sands, loams, clays & caliche-type soils. Well-drained, xeric to mesic					X	X	X			Large or shrubby evergreen with a short, stout trunk that branches out close to the ground. Has smooth, fibrous, shredding bark. Fruits take 2 years to ripen. Evergreen.	This is an excellent protective cover and nesting tree. Many species of birds & small mammals eat the berry-like fruit. Provides good food late in season. Larval host plant for the Olive hairstreak.
<i>Juniperus virginiana</i> Eastern red cedar	Cupressaceae Cypress Family	Conifer 30' - 60'	inconspicuous m catkins, f cones, appearing on separate trees March - May	Cones, berry-like, bluish, sweet & resinous when ripe. Aug. - Dec.	Full sun, part shade, dappled shade	Prefers dry hillsides, old fields, pastures, areas along fence rows.	Sands, loams & clays Well-drained, mesic. Tolerate dry land.	X	X	X	X			X	X		Evergreen tree of variable shape, with scalelike or appressed leaves. Foliage is dense and aromatic. Often planted as an ornamental. Long-lived and slow-growing. Evergreen.	Dense-foliaged tree is excellent cover and nesting tree. Bluebirds, mockingbirds, robins, cedar waxwings, thrashers, warblers, finches & sparrows relish fruit, esp. in winter. Opossum also eat fruit. Larval host plant to Olive hairstreak.

<i>Pinus edulis</i> Colorado pinyon pine	Pinaceae - Pine Family	Conifer 20' - 25'	inconspic- uous yellowish. March - April	Cones, light brown or tan- colored with brown wingless seeds. Aug. - Sept.	Full sun, part shade	Prefers mountain slopes in extreme north Trans Pecos & High Plains country.	Sands, loams & clays drained, xeric.	Well-	X	X					Small evergreen tree with short branches, furrowed bark with scaly ridges. A very handsome accent plant with attractive yellow-green needles and picturesque gnarled trunk. Highly drought-tolerant and cold-tolerant once established. Evergreen.	Woodpeckers, jays & gamebirds prize the seeds, as do small mammals. Makes an excellent cover & nesting tree.
<i>Artemisia filifolia</i> Sand sage	Asteraceae - Sunflower Family	Shrub 3' - 6'	Small ray flowers. April - May and again in Sept. - Oct.	Achenes Sept. - Oct. and later.	Full sun, part shade	Prefers dune areas, deep loose sands in Trans Pecos & Plains country.	Sands, deep drained, xeric.	Well-	X	X	X				Rounded freely branching aromatic shrub. This makes an excellent accent shrub or boundary planting or good for backdrop. Also serves as excellent erosion control plant. Persistent to evergreen.	Sand sage is excellent protective cover plant. Birds will eat the ripe achenes. Sparrows & finches are especially fond of them.
<i>Atriplex canaescens</i> Fourwing saltbush	Chenopodia ceae Goosefoot Family	Shrub 3' - 8'	Pretty spikes of m & f flowers on separate trees. April - Oct.	Showy four-winged bracted yellowish fruit. Aug. - Sept.	Full sun, part shade	Prefers grassy uplands to sandy deserts or salt or alkali flats.	Sands, loams & clays. Grows in limestone, caliche-type soils; tolerates saline soils. Well- drained, xeric.		X			X	X		An evergreen shrub with diffused branches, variable in shape. Female plants are more showy with their fall showy, yellow four-winged fruit covering the tree. This tree tolerates saline soils well and is quite drought tolerant. Evergreen.	This shrub is a valuable, palatable & nutritious food for wildlife. Fruit is eaten by scaled quail, porcupine, rock-squirrels, jack rabbits. Pollen from the flowers is sought after by bees & other many other kinds of insects.
<i>Berberis trifoliolata</i> v. <i>glauca</i>  Silver agarita	Berberi- daceae Barberry Family	Shrub 3' - 8'	Showy yellow flowers. Feb. - March	Berries, red May - July	Full sun, part shade	Prefers rocky slopes & flats of pastures, thickets & open woods.	Sands, loams or clays Xeric, well-drained.		X	X	X	X	X		Well-know striking evergreen shrub with the spiny blue-green trifoliolate leaves. This plant makes a good hedge. Flowers bloom very early in the spring. Evergreen.	Early blooming golden yellow flowers offer very early nectar for all kinds of insects. Excellent cover & nesting place due to spiny leaves. Deer rarely browse this plant unless they are hungry. Birds & mammals of several species gorge on the ripe fruit.
<i>Dalea formosa</i> Feather dalea	Leguminosa e Legume Family	Shrub 1' - 4'	Showy magenta flowers with feathery appendage April - Aug.	Flat leguminous pod covered with shaggy hair having 1 to 2 seeds. June - Oct.	Full sun, part shade	Prefers rocky hillsides & mesas at higher elevations in western Texas. Likes dry shallow soils, semi-arid limestone.	Sands, loams, clays, limestone & caliche-type soils. Well-drained, xeric.		X	X	X	X	X		Small shrub with crooked branches jutting out at angles, thick dark compound leaves & flowers growing in clusters on short spikes. Attractive feathery gray white calyx surrounds magenta blossoms. Very colorful in full bloom. Drought-tolerant. Deciduous	Flowers attract myriads of insects of all varieties. Leaves are a palatable browse for deer.

<i>Ceratoides lanata</i> Winter fat	Chenopodiaceae Goosefoot Family	Shrub 1' - 3'	Small greenish m & f flowers on same plant. April - Aug.	Showy fruit, a silvery white utricle with dense furry tufts. Aug. - Oct.	Full sun, part shade	Prefers dry sub-alkaline soils of mesas & plains from 2000 - 8000' in elevation in western Texas, the High Plains & Trans Pecos.	Sands, loams, clays, caliche-type & limestone soils. Xeric, well-drained.	X	X	X	Highly ornamental & gorgeous shrub in full fruit is back-lit by the sun. Sports fuzzy pale bluish-green leaves & beautiful silvery white fruit. Good plant for erosion control. Highly drought-tolerant once established. Persistent to evergreen.	Plants only 1 year old bear highly nutritious seeds. Provides excellent forage for mule deer & elk, also for rabbits.	
<i>Foresellesia planitierum</i> Plains greasebush	Celastraceae - Staff-Tree Family	Shrub 2' - 3'	Showy, white, five-petalled flowers 1 across. March - July	Follicle, ovoid Aug. - Sept.	Full sun, part shade	Prefers rocky calcareous slopes & breaks in western portion of the state, in the High Plains & Trans-Pecos.	Sands, loams, clays & caliche-type soils. Xeric, well-drained.	X	X	X	Irregularly branched grayish-green spiny shrub very attractive in bloom, which it does profusely. Leaves are tiny & furry. Very cold & drought-tolerant. Can't stand long, hot summers. Persistent to evergreen.	Myriads of insects are attracted to the flowers, it will just buzz with activity in the spring.	
<i>Quercus havardii</i> Havard shin-oak	Fagaceae - Beech Family	Shrub 2' - 3'	inconspicuous m & f catkins. April - May	Acorns, large, produced each year. Sept. - Oct.	Full sun, part shade	Prefers sandy plains in the lower Panhandle.	Sands, deep. Well-drained, xeric.	X	X	X	Low shrub which forms thickets in deep sands. Rather hard to get established. Leaves are muted green & leathery with furry undersides, quite variable in shape. Often grows to small tree. Deciduous.	Catkins are eaten by many species of birds in the spring. Acorns are eaten by javalina, prairie-chickens & quail. Not considered a very good browse plants. Leaves may be toxic to livestock.	
<i>Ribes odoratum</i> Buffalo current	Saxifragaceae Saxifrage Family	Shrub 4' - 6'	Showy golden yellow racemes of flowers. Feb. - May	Currents, yellow or black. June - Aug.	Full sun, part shade	Prefers cliffs, rocky slopes & sandy bluffs in western half of Texas.	Sands, loams, clays, limestone & caliche-type soils. Well-drained, xeric-mesic.	X	X	X	Highly ornamental shrub with parsley-shaped leaves, showy yellow flowers & excellent fruit. It has been widely introduced into cultivation and is relatively easy to grow. Deciduous.	Buffalo current provides excellent food for wildlife of all kinds. Insects of many varieties are attracted to the flowers and birds of all sorts flock to the berries. Foliage is browsed readily by mule deer.	
<i>Rhus microphylla</i> Little-leaf sumac	Anacardiaceae Sumac Family	Shrub 4' - 15'	Greenish-white in 2-4 clusters. April - May	Drupes, reddish-orange & hairy. May - June	Full sun, part shade	Prefers dry rocky hillsides or gravelly mesas at altitude of 2000 - 6000.' In western 3/4 of Texas.	Sands, loams, clays, caliche-type & limestone soils. Well-drained, xeric.	X	X	X	X	Clump-forming, intricately branched shrub that can get very wide. It is important to space it accordingly from 8 -20' apart. Bright orange fruits are attractive and persistent. Very drought-tolerant shrub. Deciduous.	Bright orange fruits are highly sought after by several species of birds. Though they are sour, rock squirrels & other small mammals will eat them also. Leaves are sometimes browsed by mule & white-tailed deer, but not much.



<i>Maurandya antirrhiniflora</i> Snapdragon vine	Scrophulariaceae Figwort Family	Vine Climber to 3'	Showy purple flowers. March - Sept.	Capsule, round Sept. - Dec.	Full sun, part shade	Prefers limestone hills & bluffs, also dunes, shrubs & boulders.	Sands, loams, clays. Mesic, well-drained	X	X	X	X	X	X	X	X	X	Elegant, delicate-leaved climber & ground cover. Fast grower; tolerates salt. Looks great in a pot. Leaves have excellent fall color. Not actually native to region, but will grow well there. Perennial.	Fruits are a favorite with many species of birds. Flowers are a good nectar source for many kinds of insects, especially butterflies. Lush clumps provide good cover. Larval host plant of Buckeye.				
<i>Parthenocissus vitacea</i> Hiedra creeper	Vitaceae Grape Family	Vine Climber & ground cover	inconspicuous greenish flowers. May - July	Berries, blue-black. Sept. - Nov.	Full sun	Prefers woods, thickets and on banks in west Texas.	Sands, loams, clays. drained, mesic									Well-	X	X	X	Very attractive vine with lush green palmate leaves, thicker & skinnier. Vigorous climber well able to cloak walls, columns, etc. by fastening on to masonry. Also good ground cover. Striking red-orange fall color. Drought-tolerant, prefers full sun.	Many species of birds compete for the blue-black berries including woodpeckers, kingbirds, flycatchers, cardinals, mockingbirds, bluebirds, warblers & sparrows.	
<i>Sarcostemma cynanchoides</i> Vine milkweed	Asclepiadaceae Milkweed Family	Vine Climber to 3'	Attractive whitish green flowers, sometimes purple & pinkish. July - August	Follicles, paired & spindle-shaped with comose seeds. Aug. - Oct.	Full sun, part shade	Prefers sandy hills, canyon breaks, usually climbing shrubs & fences, likes rocky soils.	Sands especially, sandy loams, clays & caliche-type soils in western half of Texas. Well-drained, xeric.										X	X	X	X	A climbing vine with trailing or twining stems, growing to about 3 feet. It has many branches & unusual complex flowers. Leaves grow in pairs with clusters of 20 whitish green flowers, pinker or purple-tinged farther west. Very ornamental & showy.	Flowers attract many pollinating insects. Stems & leaves serve as larval host plant of many milkweed butterflies like Queen & Monarch. Ripe seeds foraged by birds, & used in nest construction.
<i>Vitis arizonica</i> Canyon grape	Vitaceae - Grape Family	Vine Climber	inconspicuous whitish flowers. May - June	Grapes, blue-black. July - Aug.	Full sun, part shade	Prefers ravines & gulches at altitudes of 2000 - 7000' in western portion of the state.	Sands, loams, clays; likes limestone soils. well-drained. Xeric-mesic,										X	X	X	Very drought-tolerant climbing vine. Does not like excess moisture. It is also very cold-hardy. Good plant for erosion control. Not really native of the Rolling Plains but will grow well here. Deciduous.	Birds such as doves, several quail, woodpeckers, kingbirds, jays, flycatchers, mockingbirds, pyrruloxias, thrashers, thrushes, finches & sparrows dine voraciously on the fruit. Grapes are also a favorite of fox, skunk & coyotes. Also eaten by mule deer.	
<i>Agropyron smithii</i> Western wheatgrass	Poaceae Grass Family	Grass 1' - 3'	Flowering spikelets bluish green May - June then again. Aug. - Sept.	Seeds. Sets seed shortly after flowering.	Full sun, part shade	Prefers low, moist flats or flood plains, great in the High Plains region.	Sands, loams & clays Moist, seasonal poor drainage O.K.	X									X	X	X	Very handsome bluish-green grass that stays colorful all winter. Prefers cool summers. Needs a little watering in the summer. Can get aggressive with too much water though. Forms tight sod so not good to plant with wildflowers. Outcompetes weeds.	Western wheatgrass provides good protective cover for all sorts of animals. Grass parts are used as denning & nesting material. Many species of granivorous birds forage on the ripe seeds. Larval host plant for the Golden skipper.	



<i>Bothriochloa barbinodes</i> Cane bluestem	Poaceae Grass Family	Grass 3' - 6'	Flowering spikelets from whitish green to silver. April - Aug.	Seeds. May - Oct.	Full sun, a little shade O.K.	Prefers looser soils in the western 2/3rds of the state. Grows in open areas & grasslands.	Sands, sandy loams, loams; likes limy soils. Well-drained, xeric.	X			X	X	X	X	X	X	Very attractive accent plant or member of a pocket prairie or field of wildflowers. Perennial bunch grass.	Cane bluestem is an excellent forage grass for wildlife. Leaves are grazed, especially later on in the season. Grass parts used as nesting & denning material. Seeds eaten by granivorous birds & small mammals.
<i>Bouteloua curtipendula</i> Sideoats grama	Poaceae Grass Family	Grass 2' - 6'	Spikelets, yellowish, arranged down along stem. May - Oct.	Seeds. June - Nov.	Full sun, part shade, dappled shade	Tolerates a variety of open places throughout state. Does well in disturbed areas. Not as common in eastern forests.	Sands, loams & clays, both limestone & igneous soils. Well-drained, mesic-xeric	X	X	X	X	X	X	X	X	X	Our state grass is a strong perennial and works well as a garden accent. Competes well with short grasses but not tall-grass prairie grasses. Great choice for wildflower meadow garden. Warm-season perennial bunch grass. Dormant in winter.	Provides good grazing for wildlife and an abundance of bird seed for seed-eating birds of several varieties. Food available spring, summer & fall. Grass parts used as nesting & denning material. Larval host plant for Dotted skipper & green skipper.
<i>Bouteloua gracilis</i> Blue grama	Poaceae Grass Family	Grass. 1/2' - 3'	Spikelets, densely flowered with bluish cast. June - Oct.	Seeds. July - Nov.	Full sun, a little shade tolerated	Prefers open, grassy plains & rocky slopes in the High & Rolling Plains, also Edwards Plateau & Trans-Pecos.	Sandy loams, loams. Well-drained, xeric-mesic.				X		X	X	X	X	This attractive sod-forming perennial grass has stout rhizomes & fine leaves. It is a good choice as a meadow grass as it leaves lots of space for the wildflowers. Can be mixed with Buffalo grass. Needs a little watering. Warm-season perennial.	Provides good grazing for wildlife. Grains eaten by many species of sparrows & finches as well as other seed-eaters.
<i>Buchloe dactyloides</i> Buffalograss	Poaceae Grass Family	Grass 3 - 12	Flowering spikelets yellowish green. June - Nov. or whenever not dormant.	Seeds. Sets seed shortly after flowering.	Full sun	Prefers open areas in many kinds of soils, short-grass prairies of Central & North Central Texas.	Sands, loams & clays Xeric, well-drained.	X	X	X	X	X	X	X	X	X	This is a wonderful turf grass. It takes a little longer to establish in caliche soils. Once established, it is very drought tolerant. It turns a soft golden brown when it goes dormant. Perennial - Turf grass.	Buffalograss provides fine nesting & denning materials, especially for lining bird's nests. Seeds of male flowers are eaten by small granivorous birds. Is the larval host plant of the Green skipper.
<i>Calamovilfa gigantea</i> Prairie sandreed	Poaceae Grass Family	Grass 4' - 7'	Flowering spikelets yellowish turning to tan, panicles 10" - 12" long. June - Oct.	Seeds. Sets seed shortly after flowering.	Full sun	Prefers open sandy hills & dunes.	Sands, sandy loams. Well-drained, xeric.						X	X	X	Highly ornamental dramatic accent grass. Has a stout creeping rhizome, large flower panicles & one-flowered spikelets. This grass has great value in controlling wind erosion in deep sands that development introduces. Perennial.	Prairie sandreed provides good forage for many species of wildlife. Grass parts are used as denning & nesting material.	

<i>Muhlenbergia arenacea</i> Ear muhly	Poaceae Grass Family	Grass 4' - 14'	Flowering spikelets greenish -gray turning straw yellow. May - Nov.	Seeds June - Nov.	Full sun, a little shade O.K.	Prefers sandy plains, valley flats, also along washes.	Sands, loams & limestone soils. Well-drained, mesic-xeric.	X	X	X	Ear muhly forms extensive patches. This very delicate, elegant-looking grass can maintain itself in pure stands for several acres. It looks alot like Burrograss when not in bloom. Requires low maintenance. Mow after blooming. Low perennial.	Provides only fair grazing for wildlife. Fine leaves used to line bird's nests.						
<i>Oryzopsis hymenoides</i> Indian ricegrass	Poaceae Grass Family	Grass 1' - 2'	Flowering spikelets greenish turning ivory colored. May - July	Seeds June - August	Full sun , part shade	Prefers dry sandy slopes. In the wild, found infrequently in western half of state.	Sands, loose; loams & clays also. Well-drained, xeric	X	X	X	Indian ricegrass is a great accent plant. This infrequently found grass is very elegant & worthy of cultivation. It is beautiful all year round, especially in fall & winter. Wiry, straw-colored stems, glaucous leaves & ivory seed heads please the eye.	Seeds are readily eaten by small mammals & granivorous birds. Grass parts are used as denning & nesting material.						
<i>Schizachyrium scoparium</i> v. <i>neomexicana</i> New Mexico little bluestem	Poaceae Grass Family	Grass 2' - 5'	Flowering spikelets blue-green to silvery gold. Aug. - Nov.	Seeds Sept. - Dec.	Full sun, part shade	Prefers open rocky slopes in western part of the state.	Sands, loams & clays Well-drained, xeric.	X	X	X	Most wide-ranging bunchgrass in the state, a dominant of the tallgrass prairie. Tolerant of a wide variety of moisture & drought. Little bluestem is a symphony of beautiful color changes through the year from blue-green to coppery gold in the fall.	Provides fairly good grazing for wildlife. Good cover grass, grass parts provide denning & nesting material for birds & mammals. Larval host plant for Dusted skipper, Delaware skipper, Dixie skipper, Cross-line skipper & Cobweb skipper.						
<i>Berlandiera texana</i> Green eyes	Asteraceae Sunflower Family	Wildflower 1' - 4'	Showy yellow daisy-like flowers with green centers. April - Nov.	Achenes June - Dec.	Full sun, part shade, dappled shade	Grows along woodland edges, on hillsides & along riverbanks from Corpus Christi to the High Plains.	Sands, loams & limestone based & caliche-type soils Well-drained, xeric to mesic.	X			X	X	A very-long-lived perennial flower with showy yellow flowers. Starts blooming in the spring, but also during the summer & then again in the fall. Is responsive to a little extra watering, though it is drought-tolerant once established. Perennial.	Bees, butterflies & other nectar-loving insects are attracted to the flowers. The ripe achenes are devoured by many species of seed-eating birds.				
<i>Callirhoe involucrata</i> Winecup	Malvaceae Mallow Family	Wildflower 6" - 12"	Showy deep magenta to wine-red flowers. March - May	Capsules May - July	Full sun, part shade, dappled shade	Prefers open woods, prairies, meadows & fields	Sands, loams, clays or gravelly soils, either calcareous or acid-based. Well-drained, mesic.	X	X	X	X	X	X	X	X	X	Beautiful wine-colored wildflowers that can grace any wildflower meadow garden. These plants tend to sprawl & have trailing stems. They can even clamber over small shrubs. They respond to extra watering by blooming for a much longer of period of time.	Winecup is visited by bees which gather pollen from the flowers.



<i>Ratibida columnifera</i> Mexican hat	Asteraceae Sunflower Family	Wildflower 2' - 3'	Showy, variably-colored flowers, yellow to orange to brown with tall seedhead. May - Dec.	Achenes July - Dec.	Full sun, part shade	Grows in open fields, meadows, fields, prairies, along roadsides in western two-thirds of the state.	Sands, loams, clays, limestone-based & caliche-type soils. Well-drained, xeric.	X	X	X	X	X	X	X	X	Mexican hat varies a lot in both size & color depending on conditions. In gardens, it sometimes does better for longer with a little shade. It does not like standing water, so make sure soils are well-drained. Perennial.	Mexican hat attracts bees, butterflies & other nectar loving insects. Ripe achenes are eaten by many species of seed-eating birds.
<i>Salvia farinacea</i> Mealy sage	Lamiaceae Mint Family	Wildflower 1' - 2'	Showy dark blue flowers in spikes. April - Dec.	Nutlets June - Dec.	Full sun, part shade	Prefers dry calcareous soils of the Edwards Plateau, Trans Pecos, High Plains, Rolling Plains & elsewhere throughout the state.	Sands, loams & clays, especial limestone & caliche-type soils. Well-drained, xeric.	X	X	X	X	X	X	X	X	Mealy sage likes to grow on thin limestone soils best and prefers habitats in full sun. Does well in mass plantings & is commonly available in native plant nurseries. Perennial.	Mealy sage is always attended by a multitude of bees who forage on the nectar. Hummingbirds will also sip nectar from the tubular flowers.
<i>Sphaeralcea angustifolia</i> Copper-Mallow	Malvaceae Mallow Family	Wildflower 1' - 6'	Showy coral orange flowers on spikes. Feb. - Nov.	Capsules with seeds. April - Dec.	Full sun, part shade	Grows on sandy or rocky soils, usually on limestone or gypsum in brushlands, plains, rangelands, slopes & hillsides in High Plains, Rolling Plains, Edwards Plateau & Trans-Pecos.	Sands, loams & clays, either gypseous or calcareous soils. Well-drained, xeric.	X	X	X	X	X	X	X	X	Copper mallow performs very well in cultivation. Columns of pale orange blossoms are set off by attractive soft grayish-green foliage. Blooms for a long period of time weather permitting. Fairly drought-tolerant. Perennial.	Copper mallow is readily browsed by Mule deer & other herbivores. Bees, butterflies & other nectar & pollen loving insects are attracted to the flowers. Ripe seeds are eaten by seed-eating birds & small mammals. LHP of Common checkered skipper.
<i>Gaillardia pulchella</i> Indian blanket	Asteraceae Sunflower Family	Wildflower 1' - 2'	Showy yellow & red daisy-like flowers. March - Oct.	Achenes May - Nov.	Full sun, part shade	Prefers open grassy areas, prairies, meadows, also disturbed areas in a variety of soils.	Sands, loams & clays Well-drained, xeric-mesic.	X	X	X	X	X	X	X	X	This is a marvelously easy wildflower to grow & it comes in various coloration patters from mainly yellow to mostly reddish. Blooms most of the season from spring to late fall & provides lots of color to a wildflower meadow. Annual.	Indian blanket attracts bees, butterflies & several other varieties of small insects who forage on the nectar. Ripe seed heads are favorites with many species of seed-eating passerines like the Painted Bunting in southernmost tip of High Plains.
<i>Linum lewisii</i> Blue flax	Linaceae Flax Family	Wildflower 1' - 2'	Showy blue flowers with 5 petals. April - Oct.	Capsule with flat oily seeds. June - Nov.	Full sun, part shade	Grows in sandy rocky soils on slopes in Panhandle and Trans-Pecos.	Sands, loams, clays, limestone-based & caliche-type soils. Well-drained, xeric.	X	X	X	X	X	X	X	X	Blue flax appreciates well-drained soils and produces a profusion of beautiful blue flowers. Does well in a meadow garden or pocket prairie. Annual.	Blue flax attracts bees, butterflies & other small insects.

<i>Lupinus texensis</i> Texas bluebonnet	Leguminosae Legume Family	Wildflower 8 - 16	Showy blue and white pea-like flowers in racemes, fragrant. March - May	Legume May - July	Full sun, a little shade O.K.	Prefers open fields, meadows & prairies, also roadside areas throughout much of the state from Corpus Christi to Abilene.	Sands, loams, clays & limestone soils; really likes calcareous soils. Well-drained, mesic to xeric.	X	X	X	X	X	X	X	X	X	Our state flower, this Texas endemic cloaks meadows, prairies & roadsides come spring in an ocean of blue. An incredible sight that dazzles all newcomers to the state. Bluebonnets take a little work to get established and depend on the fall rains.	Bluebonnets are attended by bees & other insects who forage on the nectar & pollinate the plants. Plants let the bees know a particular flower has been pollinated by turning from white to dark red at the center of the banner. LHP of hairstreaks & elfins.	
<i>Machaeranthera tanacetifolia</i>  Tahoka daisy	Asteraceae Sunflower Family	Wildflower 6 - 12	Showy magenta daisy-like flowers with yellow centers March - May	Achenes May - July	Full sun, part shade	Occurs on gravelly soil flatlands, fields, prairies in the Rolling Plains, High Plains & the Trans-Pecos.	Sands, loams, clays & caliche-type soils. Well-drained, xeric.								X	X	X	This absolutely beautiful wildflower produces thick continuous blossoms for about two months before they fade. These plants work well in a shortgrass meadow or on a rocky hillside. The plant also does well in a rock garden. They love good drainage.	Tahoka daisy attracts many small bees, butterflies & other insects that are attracted to the nectar. Ripe achenes are sought after by several species of seed-eating birds.
<i>Thelesperma filifolium</i>  Greenthread	Asteraceae Sunflower Family	Wildflower 1 - 1 1/2'	Showy yellow daisy-like flowers. Feb. - Dec.	Achenes April - Dec.	Full sun, some shade O.K.	Prefers dry, calcareous soils on prairies throughout Texas. Rare in East Texas & Trans-Pecos.	Sands, loams, clays & limestone based soils. Well-drained, xeric.	X	X	X	X	X	X	X	X	X	X	Looking much like Golden-wave, this attractive, daisy-like flower grows in large masses of golden yellow over large expanses of prairie habitats. This plant prefers lots of sun & excellent drainage for best results. Annual.	Greenthread attracts nectar-loving insects of all varieties, esp. bees & butterflies. Ripe achenes, after flowers have good to seed, are highly sought after by several species of granivorous birds like the Dicksissel. LHP of Dwarf Yellow butterfly.
<i>Verbena bipinnatifida</i> Prairie verbena	Verbenaceae Vervain Family	Wildflower 6 - 12	Showy magenta to purple flowers grouped in 2-flower heads. March - Dec.	Capsule-like fruit, dry. Schizocarp May - Dec.	Full sun, some shade O.K.	Prefers prairies & fields throughout most of Texas, except for Trans-Pecos.	Sands, loams, clays & limestone-based soils. Well-drained, xeric to mesic.	X	X	X	X	X	X	X	X	X	X	Prairie verbena makes a great low-growing ground cover. Looks very good in rock gardens. Prefers full sun & limestone soils but will survive in others. Will grow in High Plains, though not originally native to the region. Annual.	Prairie vervain is an excellent butterfly plant. When in bloom it is always attended by them as they daintily park on the conveniently shaped landing-platform-shaped flower heads.

## WildScapes Plant Tables – Rolling Plains

SPECIES	FAMILY	HABIT HEIGHT	FLOWER COLOR	FRUIT	SUN EXPOSURE	HABITAT	SOILS & MOISTURE REGIME	VEGETATION ZONE										ORNAMENTAL VALUE	WILDLIFE VALUE
								1	2	3	4	5	6	7	8	9	10		
<i>Bumelia lanuginosa</i> v. <i>oblongifolia</i> Chittamwood	Sapotaceae - Sapodilla Family	Tree, large 30'-80'	White perfect flowers, fragrant. June - July	Berries, blue-black Sept. - Oct.	Full sun, Part shade	Mostly uplands, sometimes bottomlands, woodlands, edges and fencerows. This subspecies occurs on eastern half of Rolling Plains.	Sandy loams, loams, and clays. Tolerates gumbo. Well-drained, mesic	X	X	X	X	X	X	X	X	X	X	Large shade tree with simple green leaves with white woolly undersurface. Persistent	Several species of birds feed on the fruit, including cardinals, finches, robins, cedar waxwings, warblers, and vireos. Good cover and nesting tree due to protective thorns. Good substrate for insectivorous birds.
<i>Carya illinoensis</i> Pecan	Juglandaceae Walnut Family	Tree, large 50' - 60'	Inconspicuous catkins, m & f, yellowish on same tree. March - May	Nut Sept. - Oct.	Full sun, Part shade	Prefers rich bottomlands. Widely planted in shelter belts & in cultivated landscapes in Northern Plains.	Sands, loams, or clays. Well-drained, mesic	X	X	X	X	X	X	X	X	X	X	Beautiful shade tree with elegant compound leaves. Prefers deep, rich soils but will grow in thinner soils. Sometimes turns yellow in fall. Deciduous.	Sweet edible nuts valuable for all kinds of wildlife, birds and mammals alike including woodpeckers, jays, sparrows, fox squirrel, gray squirrel, opossum, and raccoons. Good substrate for insectivorous birds. Larval host plant for Gray hairstreak.
<i>Celtis laevigata</i> Sugarberry	Ulmaceae - Elm Family	Tree, large 40' - 60'	Inconspicuous, small, greenish. May - June	Berry (drupe), orange-red to purplish-black. July-Aug.	Full sun, part shade	Rocky or alluvial soils along streams, in woodlands & thickets.	Sands, loams, and clays. Prefers rich soils, but will tolerate wide range. Well-drained, mesic to xeric; drought tolerant once established	X	X	X	X	X	X	X	X	X	X	Fast-growing shade tree adapted to most soils. Very drought tolerant. Yellow autumn color. Deciduous.	Fruit eaten by bluebirds, robins, cardinals, mockingbirds, cedar waxwings, thrashers, & sparrows. Good nest & cover tree, esp. for neotropical migrants. Larval food plant for Question Mark, Mourning Cloak, Pale Emperor, Snout & Hackberry butterflies.
<i>Celtis reticulata</i> Netleaf hackberry	Ulmaceae - Elm Family	Tree, large to medium 15' - 30'	Inconspicuous greenish flowers, small & perfect. May - June	Drupe, orange-red. Aug.-Sept.	Full sun, part shade	Prefers wooded limestone slopes. Mostly restricted to North Central, Central & parts of South Texas.	Sands, loams, & clays. Likes limestone & caliche-type soils. Well-drained, mesic to xeric.		X		X	X		X	X	X	X	Can grow to be a shade tree with thickish rough-surfaced leaves with net-like veins on undersurface. Trees are strongly taprooted & extremely drought-tolerant. Deciduous.	Fleshy fruits persist on this tree in the winter making it a valuable food source for all kinds of birds: robins, cedar waxwings, bluebirds, cardinals, finches & sparrows. Fine substrate for insectivorous







<i>Cercocarpus montanus v. argenteus</i> Silverleaf mountain mahogany	Rosaceae - Rose Family	Tree, small 12' - 15'	White to yellowish flowers. March - April, further north. June - July	Fruit, slim, leathery, brown & plume-tipped. May - Nov.	Full sun, part shade	Prefers rocky slopes & canyons in Edwards Plateau, Trans-Pecos & Panhandle	Sands, loams & clays, & caliche type soils, alkaline to neutral. Well-drained, xeric.									X	X	X	X	A small persistent to evergreen tree with dark green leathery leaves with dense woolly-white undersides. Very ornamental. Is most beautiful in the late summer & fall when feather-like fruits mature. Slow to moderate grower; drought-tolerant.	While birds may use silky plumed fruit to line nests, not much fruit is eaten. White-tailed deer browse on leaves with enthusiasm.
<i>Colubrina texensis</i> Texas snakewood	Rhamnaceae - Buckthorn Family	Tree, small 5' - 15'	Small greenish-yellow perfect flowers. April - May	Drupes, dark brown to black with 2-3 nutlets. June - August	Full sun, part shade	Occurs in open areas, along hills in areas of local abundance	Sands, loams, clays & limestone soils. Well-drained, xeric.									X	X	X	X	A thicket-forming small tree or shrub with light gray divaricate twigs, urn-shaped fruit and grayish green leaves. Drought-tolerant once established. Deciduous.	Texas snakewood makes a goo protective cover & nesting tree. Several kinds of insects are attracted to the small nectar-laden flowers. Birds & small mammals will gladly eat the fruit.
<i>Diospyros texana</i> Texas persimmon	Ebenaceae - Ebony Family	Tree, small 15' - 40'	Small greenish white flowers, fragrant. March	Fruit, small, round black & fleshy with lots of seeds June - July	Full, part shade	Prefers limestone hills, shinnery oak dunes, breaks & rocky canyons, mesquite groves, areas along water courses.	Sands, loams & clays. Well-drained, xeric.		X	X	X	X	X	X					X	Very attractive tree with smooth gnarled bark. Quite drought-resistant once established. Deciduous.	Fragrant whitish flowers attract insects of many kinds. Ripe fruits eaten by several species of game & song birds. Mammals, especially javalina, relish the fruit. Leaves browsed by white-tailed deer. Larval host plant for Gray hairstreak & Henry's elfin.
<i>Juglans microcarpa</i> Little walnut	Juglandaceae - Walnut Family	Tree, small 10' - 30'	inconspicuous m & f flowers, greenish, on same trees. March - April	Walnut, small Sept. - Oct.	Full sun, part shade	Prefers rocky areas near streams, arroyos & rocky ravines in Central, South & West Texas. Occurs in Red Rolling Plains in Crosby, Donley, Floyd, Motley & Taylor counties.	Loams, clays. Likes rocky limestone soils. Well-drained, mesic					X	X	X				X	A man-trunked small tree with a long tap root. Often hybridizes with Arizona walnut. Quite disease resistant. Deciduous.	Produces small walnuts with high-quality meat eaten by rock squirrels & other small mammals. Gamebirds & songbirds also favor nuts. Good nesting & cover tree. Larval host plant of the Banded hairstreak.	
<i>Morus microphylla</i> Texas mulberry	Moraceae - Fig Family	Tree, small 10' - 25'	Small green to red inconspicuous ament-like spikes. March - April	Mulberries red to black 1-seeded drupes in syncarp. May - June	Full sun, part shade	Prefers canyons, limestone & igneous slopes in western 2/3rds of Texas.	Sands, loams, clays, caliche-type & limestone soils. Well-drained, xeric.					X	X	X	X	X	X	X	X	A small shaggy tree more often shrub with rough, sand-papery leaves & small fruits. Very drought-tolerant once established. Deciduous.	Texas mulberry makes a good cover & nesting shrub. Several species of game & song birds, as well as opossum, raccoons & squirrels relish the ripe mulberries. Quail, mourning doves & cardinals are especially fond of them. Deer often



<i>Rhamnus caroliniana</i> Carolina buckthorn	Rhamnaceae - Buckthorn Family	Tree, small 12' - 20'	inconspicuous, small greenish-yellow flowers. May - June	Drupes, reddish brown. August - Sept.	Full sun, part shade, shade	Prefers moist woods, fence rows, along creeks, heads of draws & canyon slopes.	Sands, loams & clays. Well-drained, mesic	X	X	X	X	X	X			Very attractive understory tree with pretty leaves and berries. Quite ornamental and adapted to a wide range of sites. Has good fall color & fruits borne over a long time. Deciduous.	When ripe, fruits are devoured by several species of birds, i.e. thrashers, robins, mockingbirds, cardinals, finches, etc. Flowers are good nectar source for bees, butterflies & other insects. Larval host plant for Gray hairstreak.	
<i>Rhus lanceolata</i> Lanceleaf sumac	Anacardiaceae Sumac Family	Tree, small 10' - 20'	m & f flowers, small greenish white, on separate trees. June	Drupes, small red, in clusters, remain after leaves fall. Sept. - Dec.	Full sun, part shade	Occurs on limestone & in calcareous soils, woodlands & roadside edges, along fencerows. Tolerates disturbed soils.	Sands, sandy loams, neutral clays, likes limestone soils. Well-drained, mesic				X	X	X			Sometimes thicket-forming small tree. Elegant compound leaves. Showy red fruit clusters. Trees with f flowers have fruit. Beautiful red fall color. Fast growing with a very attractive shape. Not native to Rolling Plains, but grows well here. Deciduous.	Fruit is eaten by more than 20 species of birds, favored by quail & turkey. Flowers attract numerous insects in spring, good nectar source for bees & butterflies. Leaves browsed by deer. Larval host plant for Red-banded hairstreak.	
<i>Acacia greggii</i> Gregg acacia	Leguminosae Legume Family	Ornamental small tree 5' - 9'	Showy creamy-yellow spikes with exerted stamens. April - Oct., shorter bloom time further north	Legume, light brown to reddish, persistent. July - Dec.	Full sun, part shade	Prefers chaparral & brushy areas in Rio Grande Plains, Trans Pecos & parts of Rolling Plains.	Sands, loams, clays, caliche type & limestone soils. Well-drained, xeric.		X				X	X	X	X	Thorny, thicket-forming, round-topped shrub or small tree with delicate compound leaves & creamy yellow flowers. Can form impenetrable thickets in shrub form. Deciduous.	Gregg acacia furnishes cover & shelter for small animals. Flowers attract myriads of insects. Seeds are eaten by bobwhite & scaled quail. White-tailed deer browse foliage. Pollen important bee food. Good honey plant.
<i>Acacia roemeriana</i> Roemer's acacia	Leguminosae Legume Family	Ornamental small tree 5' - 10'	Showy creamy-white flower balls. April - Aug.	Legume, brown. July - Sept.	Full sun, part shade	Prefers chaparral & brushy areas on limestone soils, gravelly bluffs & banks	Sands, loams, clays & limestone soils. Well-drained, xeric.						X	X	X	X	Round-topped, spiny shrub with many spreading branches, bipinnately compound leaves & creamy white ball-like flowers. Deciduous.	Roemer's acacia provides good protective cover & nesting sites for birds. Nectar-laden flowers attract many kinds of insects, especially bees & butterflies.

<i>Acacia wrightii</i> Wright acacia	Leguminosae - Legume Family	Ornament- al small tree 20' - 30'	Showy creamy- yellow flowers in fuzzy cylindrical spikes. March - May and after rains.	Legume, broad, light brownish green with dark brown seeds. May - August	Full sun, part shade	Prefers chaparral & woodlands along creeks & canyons	Sands, loams & clays, likes limestone, caliche-type soils. Well-drained, xeric.							X	X	X	X	Spiny shrub or small tree with wide spreading branches & irregular crown. Attractive light yellow bottlebrush-like flowers. Delicate foliage gives light shade, allowing other wildflowers to grow underneath. Fairly cold hardy for an acacia. Evergreen.	Pollen produced by flowers an important food source for bees. Makes an excellent honey tree. Good protective cover & nesting site for birds. Larval host plant for the Marine blue butterfly.
<i>Aloysia wrightii</i> Wright's lippia	Verbenaceae - Vervain Family	Ornament- al small tree 3' - 6'	Small, crowded white spikes. April - May	Calyx, 2- segment ed with 2 nutlets. June - Aug.	Full sun	Prefers rocky slopes, banks, ledges, arroyos, gullies, limestone hills & mesa slopes & desert scrub from 2000' - 6000'.	Sands, loams, clays, caliche-like limestone soils. Well-drained, xeric.							X	X	X	X	A small slender- branched hairy aromatic shrub with profusely flowering white flower spikes. Deciduous.	Wright's aloysia is an excellent honey plant. Flowers attract myriads of insects, bees & butterflies, especially. Birds will eat the ripe nutlets.
<i>Cercis canadensis v.</i> <i>texana</i> Texas redbud	Leguminosae - Legume Family	Ornament- al small tree 10' - 30'	Showy magenta pea-like flowers, before leaves. March, before leaves.	Legume s, brownish red, in clusters. Sept.	Full sun, part shade, dappled shade	Prefers thinner calcareous, rocky soils of Edwards Plateau & North Central Texas.	Sands, loams & clays; likes limestone soils. Well-drained, mesic; but less moisture than Eastern variety.				X	X		X	X			Highly ornamental and showy small tree with spreading, flat or rounded crown. Good understory tree or accent plant. Fast growing, usually with single trunk. Leaves have distinctive kidney shape & are shinier than other subspecies of Redbud. Deciduous.	Beautiful magenta flowers are copious early nectar source for butterflies, moths, bees, etc. Seeds are eaten by a number of species of birds; foliage browsed by white-tailed deer. Larval host plant to Henry's Elfin.
<i>Chilopsis linearis</i> Desert willow	Bignoniaceae - Catalpa Family	Ornament- al small tree 10' - 15'	Showy pink- magenta trumpet shaped flowers. May - Sept.	Capsule with winged seeds. Aug. - Nov.	Full sun, part shade	Prefers dry washes & gravelly creek beds, arroyos & water courses.	Sands, loams & clays. Well- drained, mesic- xeric.							X	X			Fast-growing ornamental tree with attractive willow-like leaves & very showy tubular flowers. Can be quite winter hardy. Is a phreatophyte which will extend its roots deep down to the water table. Does not like to be overwatered in cultivation. Deciduous.	Both insects & hummingbirds are attracted to the flowers. orioles & tanagers will also feed on the flowers. Various species of birds forage on the winged seeds.
<i>Cornus drummondii</i> Roughleaf dogwood	Cornaceae - Dogwood Family	Ornament- al small tree 10' - 20'	Showy, creamy- white flower heads. May - Aug.	Drupes, white, globular. Aug. - Oct.	Part shade, dappled shade, shade	Prefers damp woodlands & thickets, occasionally found on dry hills in eastern half of Texas.	Sandy loams, clays; likes limestone soils. Mesic, likes fairly moist soils				X	X		X				Irregularly branched small spreading tree with smooth gray bark, opposite leaves & creamy-white flowers. Deciduous.	Dogwood flowers are a good nectar source for many species of insects. The white fruit is highly prized & eaten by at least 40 species of birds, including bobwhite, turkey,



<i>Viburnum rufidulum</i> Rusty blackhaw viburnum	Caprifoliaceae Honeysuckle Family	Ornamental tree or large shrub 20' - 30'	Showy creamy-white clusters of flowers. March - May	Berries, bluish-black (drupes) . Sept. - Oct.	Full sun, part shade	Prefers moist soils along streamsides, in open woods & thickets.	Sands, loams & clays, esp. limestone soils. Well-drained, mesic	X	X	X	X	X	X	X	X	X	Small, single-trunked, ornamental with broad crown. Attractive as understory tree, also beautiful in the open. Leaves very glossy, turning red, mauve or orange in fall. Slow growing, staying shrub size for a long time. Deciduous.	Flowers are good nectar source for bees, butterflies & other insects. Fruits relished by several kinds of birds & small mammals. Robins, cedar waxwings, cardinals, bluebirds & mockingbirds love fruit, as do squirrels, opossum, raccoons & rabbits.
<i>Juniperus ashei</i> Ashe juniper	Cupressaceae Cypress Family	Conifer 10' - 30'	inconspicuous. February	Cones, flesh & berry-like. August - Sept.	Full sun, part shade	Prefers rocky soils in canyons, ravines, arroyos, rimrock & breaks; on eroded slopes & flats.	Sands, loams & clays likes limestone soils. Well-drained, xeric.				X	X	X	X			Multi- or single-trunked thick evergreen tree with wonderfully shaggy bark. Leaves scale-like, dark green & aromatic. Female plant with large blue fruits. Dominant plant of the hill country. Evergreen.	Bark strips used as nest material by the Golden-cheeked warbler. Blue fruits a winter-time favorite of wildlife: bluebirds, robins, cedar waxwings, cardinals, finches & mammals. Good substrate for insectivorous birds. LHP of Olive & Juniper hairstreak.
<i>Juniperus monosperma</i> One-seed juniper	Cupressaceae Cypress Family	Conifer 15' - 50'	inconspicuous, dioecious, m & f, very small. March - April	Cones, fleshy round dark blue to brownish on female tree. Sept. - Oct.	Full sun, part shade	Prefers steep slopes, broken ground about rimrock & breaks, eroded soils of arroyos & plains & in brushlands	Sands, loams, clays, caliche-type & limestone soils. Well-drained, xeric.							X	X	X	Evergreen small tree with shrubby aspect, often with several small trunks forming low, open bush-like crown. Extremely cold-hardy & drought-tolerant. Will grow rapidly but needs pruning to get character. Only female plant has berries. Hates heat.	Excellent protective cover & nesting substrate. Blue-black fruit savored by quail, raccoons, rock squirrels & several song birds. Larval host plant for several species of hairstreak butterflies.
<i>Juniperus pinchotii</i> Pinchot juniper	Cupressaceae Cypress Family	Conifer 10' - 25'	inconspicuous. February	Cones, red & berry-like, matures within a year. March	Full sun, part shade	Prefers dry hillsides & canyons of western Texas on open flats in sand & capped mesas.	Sands, loams & clays. Likes limestone or gypsum soils. Well-drained, mesic					X	X	X			Scraggly red-berried juniper good for reforesting burned out areas. Often forms thickets of excellent ground cover. Good for erosion control. Evergreen.	Several species of birds & small mammals dine on the berries. Makes an excellent place to build a nest or to escape from predators. Larval host plant of the Juniper hairstreak.
<i>Juniperus scopulorum</i> Rocky Mountain juniper	Cupressaceae Cypress Family	Conifer 20' - 36'	inconspicuous, small yellowish m & f cones. April - May	Bluish berry-like fruit takes 2 years to ripen. Nov. - Dec	Full sun, part shade	Prefers rocky areas in canyons & on breaks in Trans Pecos Guadalupe Mountains & Northern Plains.	Sands, loams, clays & caliche-type soils. Well-drained, mesic-xeric.							X	X	X	Large or shrubby evergreen with a short, stout trunk that branches out close to the ground. Has smooth, fibrous, shredding bark. Fruits take 2 years to ripen. Evergreen.	This is an excellent protective cover and nesting tree. Many species of birds & small mammals eat the berry-like fruit. Provides good food late in season. Larval host plant for the Olive hairstreak.

<i>Juniperus virginiana</i> Eastern redcedar	Cupressaceae Cypress Family	Conifer 30' - 60'	inconspicuous m catkins, f cones, appearing on separate trees. March - May	Cones, berry-like, bluish, sweet & resinous when ripe. Aug. - Dec.	Full sun, part shade, dappled shade	Prefers dry hillsides, old fields, pastures, areas along fence rows.	Sands, loams & clays. Well-drained, mesic. Tolerate dry land.	X		X	X	X				X	X	Evergreen tree of variable shape, with scalelike or appressed leaves. Foliage is dense and aromatic. Often planted as an ornamental. Long-lived and slow-growing. Evergreen.	Dense-foliaged tree is excellent cover and nesting tree. Bluebirds, mockingbirds, robins, cedar waxwings, thrashers, warblers, finches & sparrows relish fruit, esp. in winter. Opossum also eat fruit. Larval host plant to Olive hairstreak.
<i>Amorpha canescens</i> Leadplant amorpha	Leguminosae - Legume Family	Shrub 1' - 4'	Showy bluish-purple flowers on slender, dense racemes. June - July	Legume, brown with 1 brown seed. August - Sept.	Full sun, part shade	Prefers sandy prairies & stream banks. In nature a disjunct population.	Sands & sandy loams. Well-drained, mesic-xeric.		X	X		X				X	X	Erect, ascending shrub, leafed out to the base, with gray fuzzy compound leaves, bluish purple flowers & leguminous fruit. Has often been cultivated as an ornamental. Well-adapted to sandy or gravelly soils in sunny spots. Good soil cover. Deciduous.	Flowers attract several kinds of insects. Game species browse both on the leaves and the fruits.
<i>Amorpha fruticosa</i> False indigo	Leguminosae - Legume Family	Shrub 5' 10'	Showy purple flower spikes with yellow anthers. April - May	Pods, clustered, small & brown. July - Aug.	Full sun, part shade	Prefers low areas at the water's edge, along streams.	Sands, loams & clays. Mesic, seasonally poor drainage O.K.	X	X	X		X	X					This moisture loving shrub is notable for its beautiful flowers, attractive leaves & airy form. Relatively fast growing. Deciduous.	Flowers are a good nectar source for bees, butterflies & other insects. Leaves are browsed by deer. Larval host plant for Dogface butterfly, Gray hairstreak, Silver-spotted skipper, Hoary edge skipper.
<i>Artemisia filifolia</i> Sand sage	Asteraceae - Sunflower Family	Shrub 3' - 6'	Small ray flowers. April - May and again in Sept. - Oct.	Achenes. Sept. - Oct. and later	Full sun, part shade	Prefers dune areas, deep loose sands in Trans Pecos & Plains country.	Sands, deep. Well-drained, xeric.									X	X	Rounded freely branching aromatic shrub. This makes an excellent accent shrub or boundary planting or good for backdrop. Also serves as excellent erosion control plant. Persistent to Evergreen.	Sand sage is excellent protective cover plant. Birds will eat the ripe achenes. Sparrows & finches are especially fond of them.
<i>Atriplex canescens</i> Fourwing saltbush	Chenopodiaceae Goosefoot Family	Shrub 3' - 8'	Pretty spikes of m & f flowers on separate trees. April - Oct.	Showy four-winged bracted yellowish fruit. August - Sept.	Full sun, part shade	Prefers grassy uplands to sandy deserts or salt or alkali flats.	Sands, loams & clays. Grows in limestone, caliche-type soils; tolerates saline soils. Well-drained, xeric.						X			X	X	An evergreen shrub with diffused branches, variable in shape. Female plants are more showy with their fall showy, yellow four-winged fruit covering the tree. This tree tolerates	This shrub is a valuable, palatable & nutritious food for wildlife. Fruit is eaten by scaled quail, porcupine, rock-squirrels, jack rabbits. Pollen from the flowers is sought after by bees & other many other

																		saline soils well and is quite drought tolerant. Evergreen.	kinds of insects.
<i>Berberis trifoliolata</i> Agarita	Berberidaceae Barberry Family	Shrub 3' - 8'	Showy yellow flowers. Feb. - March	Berries, red. May - July	Full sun, part shade	Prefers rocky slopes & flats of pastures, thickets & open woods	Sands, loams or clays. Well-drained, xeric.	X				X	X	X	X	X	X	Well-know striking evergreen shrub with the spiny blue-green trifoliolate leaves. This plant makes a good hedge. Flowers bloom very early in the spring. Evergreen.	Early blooming golden yellow flowers offer very early nectar for all kinds of insects. Excellent cover & nesting place due to spiny leaves. Deer rarely browse this plant unless they are hungry. Birds & mammals of several species gorge on the ripe fruit.
<i>Chrysothamnus nauseosus</i> v <i>graveolans</i> Rabbit brush	Asteraceae - Sunflower Family	Shrub 1' - 9'	Showy yellow flower clusters. Sept. - Oct.	Achenes, linear with copious, showy white or tawny pappas. Oct. - Dec.	Full sun, part shade	Prefers draws on Rolling Plains in the Panhandle from 3000' and above elevation.	Sands and caliche soils. Well-drained, xeric.									X		Very showy, densely-branched western shrub forming a rounded clump, with deep root system. Prefers cool summers. Leaves are pungently aromatic. Good shrub for erosion control. Persistent to Evergreen.	This is an excellent honey plant. Flowers attract several kinds of insects, especially bees & butterflies. Achenes are eaten by several species of seed-eating birds. Birds will also use the plumed achenes in nest construction. Mule deer browse foliage.
<i>Dalea formosa</i> Feather dalea	Leguminosae - Legume Family	Shrub 1' - 4'	Showy magenta flowers with feathery appendage. April - August	Flat leguminous pod covered with shaggy hair having 1 to 2 seeds. June - Oct.	Full sun, part shade	Prefers rocky hillsides & mesas at higher elevations in western Texas. Likes dry shallow soils, semi-arid limestone.	Sands, loams, clays, limestone & caliche-type soils. Well-drained, xeric.						X	X	X	X	X	Small shrub with crooked branches jutting out at angles, thick dark compound leaves & flowers growing in clusters on short spikes. Attractive feathery gray white calyx surrounds magenta blossoms. Very colorful in full bloom. Drought-tolerant. Deciduous.	Flowers attract myriads of insects of all varieties. Leaves are a palatable browse for deer.
<i>Ephedra antisiphilitica</i> Jointfir	Ephedraceae - Ephedra Family	Shrub 3' - 6'	Greenish-yellow to reddish flowers. May - June	Males have tiny cones, females, red berries. July -	Full sun, part shade	Prefers gravelly or rocky soil on plains, hills, breaks, rimrock in arroyos, ravines & canyons.	Sands, loams, clays & caliche-type soils. Well-drained, xeric.						X	X	X	X		Interesting shrub with an erect spreading habit. It can be hard to grow, worth the work. Definitely keep it if you already have it on your property. Branches are evergreen with tiny scale leaves.	Birds will forage on the red berries. Deer love to browse on this plant so you might want to hide it under something thorny.





<i>Rhus aromatica</i> v <i>flabelliformis</i> Fragrant sumac	Anacardiaceae Sumac Family	Shrub 3' - 8'	inconspicuous yellow flowers appearing before leaves. Feb. - March	Berries, red. May - June	Full sun, part shade, dappled shade.	Prefers limestone outcrops, rocky slopes, prairies, & mesquite plains.	Sands, loams & clays. Likes limestone soils. Well-drained, mesic	X	X	X	X	X	X	X	X	X	X	Aromatic shrub with pretty leaves & early flowers. Tends to form thickets & is irregularly branched. Deciduous.	Early flowers provide early nectar source for insects like bees, butterflies & moths. The red berries are one of the earliest summer fruits making it popular with several species of birds & small mammals. Larval host plant to Red-banded hairstreak.
<i>Rhus microphylla</i> Littleleaf sumac	Anacardiaceae Sumac Family	Shrub 4' - 15'	Greenish-white in 2-4" clusters. April - May	Drupes, reddish-orange & hairy. May - June	Full sun, part shade	Prefers dry rocky hillsides or gravelly mesas at altitude of 2000 - 6000' In western 3/4 of Texas.	Sands, loams, clays, caliche-type & limestone soils. Well-drained, xeric.					X	X	X	X	X	X	Clump-forming, intricately branched shrub that can get very wide. It is important to space it accordingly from 8 -20' apart. Bright orange fruits are attractive and persistent. Very drought-tolerant shrub. Deciduous.	Bright orange fruits are highly sought after by several species of birds. Though they are sour, rock squirrels & other small mammals will eat them also. Leaves are sometimes browsed by mule & white-tailed deer, but not much.
<i>Salvia greggii</i> Autumn sage	Lamiaceae - Mint Family	Shrub 2' - 4'	Showy magenta red flowers, also comes in white, pink or coral. April - Dec.	Nutlets. June - Dec.	Full sun, part shade	Prefers rocky soils in central, south & west Texas.	Sands, loams & clays. Likes limestone soils, esp. Well-drained, mesic-xeric.					X	X	X	X	X	X	Aromatic showy shrub which blooms prolifically spring, summer & fall. Adaptable to other areas of the state where not native. Good as ground cover or hedge. Really needs good drainage. Persistent (almost evergreen).	Abundant flowers provide copious nectar which is attractive to bees & especially hummingbirds. Ruby-throats can't seem to get enough. Provides food over the long hot summer for them when other plants have waned.
<i>Symphoricarpos orbiculata</i> Coralberry	Caprifoliaceae Honeysuckle Family	Shrub 1 1/2' - 6'	Showy, many-flowered greenish-white or pink, in terminal spikes. June - August	Drupe, berry-like, pink to coral-red. Sept. - Oct.	Dappled shade, part shade	Prefers woods, thickets & streamside areas in eastern 1/3 of Texas. Not native to the Rolling Plains but will grow here.	Sands, loams & clays. Well-drained, mesic	X	X	X	X	X	X					Hardy, slender erect thicket-forming shrub with brown shreddy bark & opposite oval-shaped leaves. Great erosion control plant. Highly ornamental. Deciduous.	Excellent cover shrub when bushy. Fruits are eaten by at least 12 species of birds including cardinals, bobwhite, quail, wild turkey bluebirds, robins, mockingbirds, thrashers & cedar waxwings.
<i>Hesperaloe parviflora</i> Red yucca	Agavaceae - Agave Family	Succulent Leaves 2-3' Flower stalk 5'	Showy, coral to salmon pink flowers on tall stalk. May - Nov	Capsules. Aug. - Dec.	Full sun, part shade, dappled shade	Prefers prairies, rocky slopes & mesquite groves	Sands, loams & clays; likes limestone soils. Well-drained, xeric.			X	X	X	X					Very elegant succulent, used a lot in landscapes as an accent plant. Widely adaptable to various soils. Flowers bloom profusely and for a long time. Evergreen.	Ruby-throated and Black-chinned hummingbirds are highly attracted to flowers which provide copious nectar for long periods. White-tailed deer also love to eat the flowers.

<i>Opuntia imbricata</i> Teddybear cholla	Cactaceae - Cactus Family	Succulent 3' - 9'	Showy hot pink flowers. May - June	Bright yellow tunas. Sept. - Oct.	Full sun, part shade	Prefers dry, rocky soils or sandy soils at elevations from 1200 - 1800'	Sands, caliche-like & limestone soils. Well-drained, xeric.										X	X	Highly attractive, prickly shrub which is great from landscapes. It becomes tree-like in time. While it is a slow grower, it assumes a marvelous shape with time. If it rains, blooms are shinny. Plant is hard to handle because of spines. Evergreen.	Flowers are highly attractive to several kinds of insects especially bees. Tunas are eaten by several species of birds. A spectacularly safe nesting tree, especially for Cactus Wren and Greater Roadrunner.
<i>Opuntia lindheimeri</i> Pricklypear cactus	Cactaceae - Cactus Family	Succulent 1' - 5'	Showy yellow or orange to red flowers. May	Tuna, purplish. Sept. - Oct.	Full sun	Prefers open areas, woodlands, openings, pastures, disturbed & eroded soils O.K.	Sands, loams & clays. Well-drained, xeric.		X				X	X	X	X	X	X	Hardy succulent with attractive flowers & juicy rosy-purplish fruits. Makes a good barrier plant. Evergreen.	Flowers attract many kinds of insects, especially bees, moths, butterflies, beetles & flies, etc. which are attracted to both nectar & pollen. Fruits & pads are highly sought after by several species of mammals which must brave the guard glochids.
<i>Yucca angustifolia</i> Narrowleaf yucca	Agavaceae - Agave Family	Succulent 1-2' leaves 2'- 6' flower stalk	Showy panicles of creamy-white flowers. June - July	Capsules. Sept. - Oct.	Full sun, part shade	Prefers rolling, well-drained grasslands & plains.	Sands, loams & clays. Well-drained, xeric.						X				X	X	Very winter-hardy attractive accent plant, magnificent when in bloom. This plant is the most flower-like of all the yuccas. Leaves are pale green edged with fine, curly white hairs. Tips are armed with healthy spines. Can tolerate shade. Evergreen.	Waxy white flowers emit their fragrance at night attracting moths which pollinate them. Flowers are edible and popular with white-tailed deer. Larval host plant to Yucca giant skipper & Strecker's giant skipper.
<i>Yucca arkansana</i> Threadleaf yucca	Agavaceae - Agave Family	Succulent 2' leaves 3'- 6' flower stalk	Showy panicles of creamy-white flowers. May - June	Capsules. August - Sept.	Full sun, part shade	Prefers prairies, limestone outcrops & rocky areas	Sands, loams & clays. Well-drained, xeric.		X	X	X	X							Very striking accent plant, magnificent when in bloom. This plant is the most flower-like of all the yuccas. Leaves are pale green edged with fine, curly white hairs. Tips are armed with healthy spines. Can tolerate shade. Evergreen.	Elegant waxy flowers emit their fragrance at night attracting moths which pollinate them. Flowers are edible and popular with white-tailed deer. Larval host plant to Yucca giant skipper.
<i>Ampelopsis cordata</i> Heartleaf ampelopsis	Vitaceae - Grape Family	Vine. High climber	inconspicuous greenish flowers. May - June	Berries, bluish-purple. Aug. - Nov.	Part shade, dappled shade, shade	Prefers rich woodlands & bottomlands along rivers & streams.	Sands, loams & clays; likes limestone, caliche-type soils. Well-drained, but moist.	X	X	X	X	X	X	X	X				Vine with pretty heart-shaped leaves & bluish-purple fruit. Very fast growing climber. Deciduous.	A number of species of birds consume the fruit, including cardinals, bobwhite, woodpeckers, brown thrashers, hermit thrushes, finches &



<i>Parthenocissus vitacea</i> Hiedra creeper	Vitaceae Grape Family	Vine Climber & ground cover	inconspicuous greenish flowers. May - July	Berries, blue-black. Sept. - Nov.	Full sun	Prefers woods, thickets and on banks in west Texas.	Sands, loams, clays. Well-drained, mesic									X	X	X	Very attractive vine with lush green palmate leaves. Vigorous climber well able to cloak walls, columns, etc. by fastening on to masonry. Also good ground cover. Striking red-orange fall color. Drought-tolerant, prefers full sun. Deciduous.	Many species of birds compete for the blue-black berries including woodpeckers, kingbirds, flycatchers, cardinals, mockingbirds, bluebirds, warblers & sparrows.
<i>Vitis acerifolia</i> Panhandle grape	Vitaceae - Grape Family	Vine Climber	inconspicuous whitish flowers. May - June	Grapes, blue-purple to black, sweet. July - Aug.	Full sun, part shade	Prefers low, open woods in stream bottoms, dunes & rocky slopes in Panhandle	Sands, loams & clays, also limestone & caliche-like soils. Well-drained, mesic						X			X	X	X	Stocky, erect, much-branched vine that climbs rarely, but loves to cover rockers & shrubs with pretty light grayish green leaves with cobwebby appearance. Fruits ripen early & are very edible. Deciduous.	The ripe grapes are highly favored by several species of gamebirds & songbirds. Rock squirrels, raccoons, & foxes also partake of them.
<i>Vitis arizonica</i> Canyon grape	Vitaceae - Grape Family	Vine Climber	inconspicuous whitish flowers. May - June	Grapes, blue-black. July - Aug.	Full sun, part shade	Prefers ravines & gulches at altitudes of 2000 - 7000' in western portion of the state.	Sands, loams, clays; likes limestone soils. Xeric-mesic, well-drained.										X	X	Very drought-tolerant climbing vine. Does not like excess moisture. It is also very cold-hardy. Good plant for erosion control. Not really native of the Rolling Plains but will grow well here. Deciduous.	Birds such as doves, several quail, woodpeckers, kingbirds, jays, flycatchers, mockingbirds, pyrruloxias, thrashers, thrushes, finches & sparrows dine voraciously on the fruit. Grapes are also a favorite of fox, skunk & coyotes. Also eaten by mule deer.
<i>Agropyron smithii</i> Western wheatgrass	Poaceae - Grass Family	Grass 1' - 3'	Flowering spikelets bluish green. May - June then again. Aug. - Sept.	Seeds. Sets seed shortly after flowering	Full sun, part shade	Prefers low, moist flats or flood plains, great in the High Plains region.	Sands, loams & clays. Moist, seasonal poor drainage O.K.				X					X	X	X	Very handsome bluish-green grass that stays colorful all winter. Prefers cool summers. Needs a little watering in the summer. Can get aggressive with too much water. Forms tight sod so not good to plant with wildflowers. Outcompetes weeds. Perennial.	Western wheatgrass provides good protective cover for all sorts of animals. Grass parts are used as denning & nesting material. Many species of granivorous birds forage on the ripe seeds. Larval host plant for the Golden skipper.

<i>Andropogon gerardi</i> Big bluestem	Poaceae Grass Family	Grass 3' - 6'	Flowering spikelets of green to golden-tan in form of turkey foot. Aug. - Nov.	Seeds. Sets seed shortly after flowering	Full sun	Prefers moist soils of meadows & prairies in the eastern 1/2 of state	Sands, loams & clays, acid or calcareous. mesic; moderate moisture	X	X	X	X	X	X	X	X	X	X	X	This big prairie perennial can be used as a meadow grass with wildflowers, a pocket tallgrass prairie or a garden accent. Adds a dramatic component. Needs rich, deep soil with moisture present. Good erosion control. Best placed at bottom of slope.	Provides good cover & food for many species of wildlife. Grass parts used as nesting & denning material. Larval host plant of Delaware Skipper, Dusted Skipper, Bunchgrass Skipper, Large Wood Nymph, Cobweb, Clouded & Beard grass skippers.
<i>Andropogon gerardi v paucipilus</i> Sand big bluestem	Poaceae Grass Family	Grass 5' - 8'	Flowering spikelets darker & hairier turning yellowish. Aug. - Nov.	Seeds. Sets seed shortly after flowering	Full sun, part shade	Prefers sandy soils in western part of the state.	Sands & sandy loams. Well-drained, mesic-xeric.									X	X	X	This big prairie perennial can be used as a meadow grass with wildflowers, a pocket tallgrass prairie or a garden accent in sandy areas. Adds a dramatic component. Needs sandy soils with moisture present. Good erosion control.	Provides good cover & food for many species of wildlife. Grass parts used as nesting & denning material. Larval host plant of Delaware Skipper, Dusted Skipper, Bunchgrass Skipper, Large Wood Nymph, Cobweb, Clouded & Beard grass skippers.
<i>Bothriochloa barbinodes</i> Cane bluestem	Poaceae Grass Family	Grass 3' - 6'	Flowering spikelets from whitish green to silver. April - Aug.	Seeds. May - Oct.	Full sun, a little shade O.K.	Prefers looser soils in the western 2/3rds of the state. Grows in open areas & grasslands.	Sands, sandy loams, loams; likes limy soils. Well-drained, xeric.		X			X	X	X	X	X	X	X	Very attractive accent plant or member of a pocket prairie or field of wildflowers. Perennial bunch grass.	Cane bluestem is an excellent forage grass for wildlife. Leaves are grazed, especially later on in the season. Grass parts used as nesting & denning material. Seeds eaten by granivorous birds & small mammals.
<i>Bouteloua curtipendula</i> Sideoats grama	Poaceae Grass Family	Grass 2' - 6'	Spikelets, yellowish, arranged down along stem. May - Oct	Seeds. June - Nov.	Full sun, part shade, dappled shade	Tolerates a variety of open places throughout state. Does well in disturbed areas. Not as common in eastern forests.	Sands, loams & clays, both limestone & igneous soils. Well-drained, mesic-xeric.	X	X	X	X	X	X	X	X	X	X	X	Our state grass is a strong perennial and works well as a garden accent. Competes well with short grasses but not tall-grass prairie grasses. Great choice for wildflower meadow garden. Warm-season perennial bunch grass. Dormant in winter.	Provides good grazing for wildlife and an abundance of bird seed for seed-eating birds of several varieties. Food available spring, summer & fall. Grass parts used as nesting & denning material. Larval host plant for Dotted skipper & green skipper.



<i>Hilaria berlangeri</i> Curlymesquite	Poaceae Grass Family	Grass 4" - 6"	Flowering spikelets greenish gray to silvery in fall. July - Nov.	Seeds. Aug. - Nov.	Full sun, a little shade O.K.	Prefers rocky slopes, dry hillsides & grassy or brushy plains.	Thin limestone soils, clays & caliche type soils. Also sands & loams. Well- drained, xeric.					X	X	X	X	X	X	X	Curly-mesquite looks a bit like Buffalograss & can be used as a lawn grass, but it can be somewhat lumpy. It makes a better ground cover. Warm-season perennial.	Seed heads are eaten by various granivorous birds. Grass parts are used as nesting & denning material by a variety of small wildlife species.
<i>Leptochloa dubia</i> Green sprangletop	Poaceae Grass Family	Grass 1' - 3'	Flowering spikelets greenish turning yellowish. May - Nov.	Seeds. June - Nov.	Full sun, part shade	Prefers open areas on loose, rocky soils.	Sands, loams & clays, especially loose soils. Well- drained, mesic- xeric.		X			X	X	X	X	X	X	X	This green tufted perennial with open seedhead grows in all regions but most common in western part of the state. Warm- season perennial.	Green sprangletop is an excellent forage grass for all grazing wildlife. The seeds are eaten by several species of sparrows & finches. Grass parts are used as nesting & denning material.
<i>Muhlenbergia arenacea</i> Ear muhly	Poaceae Grass Family	Grass 4' - 14"	Flowering spikelets greenish - gray turning straw yellow. May - Nov.	Seeds. June - Nov.	Full sun, a little shade O.K.	Prefers sandy plains, valley flats, also along washes.	Sands, loams & limestone soils. Well-drained, mesic-xeric.										X	X	Ear muhly forms extensive patches. This very delicate, elegant- looking grass can maintain itself in pure stands for several acres. It looks alot like Burrowgrass when not in bloom. Requires low maintenance. Mow after blooming. Low perennial.	Provides only fair grazing for wildlife. Fine leaves used to line bird's nests.
<i>Panicum virgatum</i> Switchgrass	Poaceae Grass Family	Grass 3' - 6'	Flowering spikelets green turning rich gold. Aug. - Sept.	Seeds. Oct. - Nov.	Full sun, part shade	Prefers seasonally moist, open areas throughout Texas.	Sands, loams & clays. Moist. Seasonal poor drainage O.K.	X	X	X	X	X	X	X	X	X	X	X	Gorgeous tall-grass can be used as dramatic accent plant. Turns deep, rich golden color in fall. Has airy, filigreed seedhead. Can also be used in small pocket prairie. Does great in Houston, loves the extra water. Warm-season perennial bunch grass.	Provides fair grazing for wildlife, seeds sought after by seed-eating birds. Excellent sparrow food in winter. Provides good protective cover and nesting & denning material. Good place for butterflies to get out of the wind. LHP for Delaware skipper.
<i>Poa arachnifera</i> Texas bluegrass	Poaceae Grass Family	Grass 1' - 2'	Flowering spikelets bluish- green to mauve. April - May	Seeds. May.	Full sun, part shade	Grows in prairies and openings of woods	Sands, loams & clays. Mesic	X	X	X	X	X	X	X	X	X	X	X	This is an absolutely beautiful grass, in both color & shape of flower head. Two color forms are blue-green and copper mauve. Cool season perennial.	Provides fair grazing for wildlife & seeds for sparrows & other granivorous birds & small mammals. Grass parts used as nesting & denning material.



<i>Schizachyrium scoparium v. neomexicana</i> New Mexico little bluestem	Poaceae Grass Family	Grass 2' - 5'	Flowering spikelets blue-green to silvery gold. Aug. - Nov.	Seeds. Sept. - Dec.	Full sun, part shade	Prefers open rocky slopes in western part of the state.	Sands, loams & clays. Well-drained, xeric.									X	X	X	Most wide-ranging bunchgrass in the state, dominant of the tallgrass prairie. Tolerant of wide variety of moisture & drought. Little bluestem is a symphony of beautiful color changes through the year from blue-green to coppery gold in the fall. Perennial.	Provides fairly good grazing for wildlife. Good cover grass, grass parts provide denning & nesting material for birds & mammals. Larval host plant for Dusted skipper, Delaware skipper, Dixie skipper, Cross-line skipper & Cobweb skipper.	
<i>Scleropogon brevifolius</i> Burrograss	Poaceae Grass Family	Grass 4" - 9"	Flowering spikelets hairy, pink or white. July - Aug.	Seeds. July - Sept.	Full sun, a little shade O.K.	Prefers open, dry, rocky slopes & plains in central & western portions of state.	Sands, loams, clays, caliche-type & calcareous soils. Well-drained, xeric.										X	X	X	Very aggressive but useful landscape grass. Blooms appear after heavy rains. Grass turns greenish after blooming with more rain. More drought-tolerant than Buffalograss. Best to mow after blooming. Forms thick sod. Cool season perennial.	Provides poor grazing for wildlife. But good lawn grass in dry areas. Fine leaves used to line bird's nests.
<i>Sorghastrum nutans</i> Indiangrass	Poaceae Grass Family	Grass 3' - 8'	Flowering spikelets a deep yellow. Oct. - Nov.	Seeds. Nov. - Dec.	Full sun, some shade O.K.	Prefers moist rich soils of tall-grass prairies of central & coastal TX	Sands, loams & clays. Likes calcareous soils. Mesic, likes moisture.		X	X	X	X					X			This gorgeous grass was major component of tallgrass prairie. Striking accent plant or member of pocket tallgrass prairie. Does well in a naturally moist rich swale area. Warm-season perennial bunch grass. Dormant in winter.	Fairly good grazing for wildlife when green. Seed-eating birds and small mammals eat ripe seeds. Stems, leaves used as nesting & denning material. Provides excellent protective cover for wildlife. Larval host plant of Pepper-and-salt skipper.
<i>Berlandiera texana</i> Green eyes	Asteraceae Sunflower Family	Wildflower 1' - 4'	Showy yellow daisy-like flowers with green centers. April - Nov.	Achenes . June - Dec.	Full sun, part shade, dappled shade	Grows along woodland edges, on hillsides & along riverbanks from Corpus Christi to the High Plains.	Sands, loams & limestone based & caliche-type soils. Well-drained, mesic-xeric.		X								X	X		A very-long-lived perennial flower with showy yellow flowers. Starts blooming in the spring, but also during the summer & then again in the fall. Is responsive to a little extra watering, though it is drought-tolerant once established. Perennial.	Bees, butterflies & other nectar-loving insects are attracted to the flowers. The ripe achenes are devoured by many species of seed-eating birds.

<i>Callirhoe involucrata</i> Winecup	Malvaceae Mallow Family	Wildflower 6" - 12"	Showy deep magenta to wine-red flowers. March - May	Capsule s. May - July	Full sun, part shade, dappled shade	Prefers open woods, prairies, meadows & fields	Sands, loams, clays or gravelly soils, either calcareous or acid-based. Well-drained, mesic	X	X	X	X	X	X	X	X	X	Beautiful wine-colored wildflowers that can grace any wildflower meadow garden. These plants tend to sprawl & have trailing stems. Even clambering over small shrubs. Respond to extra watering by blooming for a much longer of period of time. Perennial.	Winecup is visited by bees which gather pollen from the flowers.
<i>Calylophus drummondianus</i> Squarebud eveningprimrose	Onagraceae Evening-primrose Family	Wildflower 1' - 1 1/2'	Showy yellow flowers with black center. March - July	Capsule with seeds. May - Nov.	Full sun, part shade	Grows on sandy or rocky soils in open fields, prairies, meadows throughout most of the state.	Sands, loams, clays, limestone-based & caliche-type soils. Well-drained, xeric.			X	X	X	X	X	X	X	Showy, upright, bushy clumps of yellow flowers. Leaves narrow with spiny-toothed margins. Habit is sometimes sprawling or reclining with flowers remaining open throughout the day. Good in a rock garden as it needs excellent drainage to thrive. Perennial.	A wide array of diurnal insects are attracted to the flowers which are open throughout the day.
<i>Englemannia pinnatifida</i> Engelmann daisy	Asteraceae Sunflower Family	Wildflower 1' - 3'	Showy yellow daisy-like flowers. Feb. - Nov.	Achenes. April - Dec.	Full sun, part shade, dappled shade	Grows in opens fields, meadows, along roadsides throughout much of the state.	Sands, loams & clays; neutral to calcareous soils. Well-drained, mesic-xeric.	X	X	X	X	X	X	X	X	X	Lemon-yellow flowers blanket the fields & roadsides especially in the spring. With a little extra water in your garden, these flowers will prolong bloom-time through the summer. Perennial.	Englemann daisy attracts a multitude of bees, butterflies & other insects which forage on the nectar. Seed-eating birds such as sparrows, buntings & finches dine on the ripe achenes in the fall.
<i>Hymenoxys scaposa</i> Slenderstem bitterweed	Asteraceae Sunflower Family	Wildflower 3" - 6"	Showy yellow daisy-like flowers. March - Oct.	Achenes. June - Nov.	Full sun, part shade	Grows on dry calcareous soils & on caliche banks throughout much of western Texas.	Sands, loams, clays, limestone-based & caliche-type soils. Well-drained, xeric.							X	X	X	This bright yellow daisy-like flower atop a slender scape is graceful & elegant as it peppers a landscape. The species works well in a rock garden & appreciates good drainage. The plant is highly aromatic X96. Perennial.	Bees, butterflies & other small insects forage for nectar from the flowers. Ripe achenes are eaten by small seed-eating birds. Foliage is bitter & not highly prized by herbivorous animals.

<i>Melampodium leucanthum</i> Blackfoot daisy	Asteraceae Sunflower Family	Wildflower 6" - 12"	Showy white clumps of daisy-like flowers, fragrant. March - Nov	Achenes May - Dec.	Full sun, part shade	Prefers limestone & calcareous soils in open, dry rocky areas in Edwards Plateau, Trans-Pecos, High Plains & Rolling Plains	Sands, limestone-based or caliche-type soils. Well-drained, xeric.										X	X	X	Blackfoot daisy does very well in a rock garden providing showy clumps of white daisy-like flowers. Continues to bloom throughout the season especially after rains. Slightly cold-sensitive. Perennial.	Blackfoot daisy attracts bees, butterflies & other small insects who gather the nectar. Ripe seed heads provide food for small seed-eating birds.	
<i>Oenothera macrocarpa</i> Missouri evening primrose	Onagraceae Evening-primrose Family	Wildflower 1'	Showy, fluttery yellow flowers. April - June	Capsule with numerous seeds. June - Aug.	Full sun	Grows on dry, thin, rocky exposed calcareous soils on hillsides, slopes, on prairies & cliffs in Edwards Plateau, Blackland Prairies, High Plains & Rolling Plains.	Sands, limestone & caliche-type soils. Well-drained, xeric.					X						X	X	Missouri primrose has large fluttery yellow petals which open in the evening. Plants are great in a rock garden. Spent flowers turn pinkish coral. Perennial.	Missouri primrose flowers are pollinated by nocturnal moths.	
<i>Penstemon ambiguus</i> Pink plains penstemon	Scrophulariaceae Figwort Family	Wildflower 1' - 4'	Showy pale pink flowers. May - Oct.	Capsule with seeds. July - Nov.	Full sun, part shade	Grows in open areas, prairies, meadows & fields in High Plains, Rolling Plains & the Trans-Pecos.	Sands, but will also grow in heavier soils. Well-drained, xeric.												X	X	Pink plains penstemon produces masses of color for long periods of time in the summer until the first frost. While the plant prefers sandy habitats, it will also grow in loams & clays. Perennial.	Pink plains penstemon attracts a wide variety of insects that forage on the nectar. Clumps of them offer cover & hiding places for small creatures.
<i>Penstemon cobaea</i> Giant foxglove	Scrophulariaceae Figwort Family	Wildflower 1' - 2 1/2'	Showy large tubular pale violet flowers with nectar guides. April - May	Capsules with seeds June - July	Full sun, part shade	Prefers open areas, meadows, prairies, pastures & roadside areas	Sands, loams, clays & limestone outcrops. Well-drained, mesic		X	X	X								X	X	Giant foxglove is our largest-flowered penstemon. In full boom, gorgeous flowers open, covering two thirds of the flower stalk. This is a beautiful choice for a wildflower meadow or pocket prairie. It loves limestone soils. Perennial.	Giant foxglove is highly attractive to bees, especially the larger varieties such as bumblebees and carpenter bees who eagerly forage for the nectar & the pollen. Larval host plant of the Dotted checkerspot.
<i>Ratibida columnifera</i> Mexican hat	Asteraceae Sunflower Family	Wildflower 2' - 3'	Showy, variably-colored flowers, yellow to orange to brown with tall seedhead. May - Dec.	Achenes July - Dec.	Full sun, part shade	Grows in open fields, meadows, fields, prairies, along roadsides in western two-thirds of the state.	Sands, loams, clays, limestone-based & caliche-type soils. Well-drained, xeric.			X	X	X	X	X	X	X	X	X	X	X	Mexican hat varies a lot in both size & color depending on conditions. In gardens, it sometimes does better for longer with a little shade. It does not like standing water, so make sure soils are well-drained. Perennial.	Mexican hat attracts bees, butterflies & other nectar loving insects. Ripe achenes are eaten by many species of seed-eating birds.

<i>Salvia farinacea</i> Mealy sage	Lamiaceae Mint Family	Wildflower 1' - 2'	Showy dark blue flowers in spikes. April - Dec.	Nutlets. June - Dec.	Full sun, part shade	Prefers dry calcareous soils of the Edwards Plateau, Trans Pecos, High Plains, Rolling Plains & elsewhere throughout the state.	Sands, loams & clays, especial limestone & caliche-type soils. Well-drained, xeric.						X	X	X	X	X	X	Mealy sage likes to grow on thin limestone soils best and prefers habitats in full sun. Does well in mass plantings & is commonly available in native plant nurseries. Perennial.	Mealy sage is always attended by a multitude of bees who forage on the nectar. Hummingbirds will also sip nectar from the tubular flowers.
<i>Sphaeralcea angustifolia</i> Coppermallow	Malvaceae Mallow Family	Wildflower 1' - 6'	Showy coral orange flowers on spikes. Feb. - Nov.	Capsules with seeds. April - Dec.	Full sun, part shade	Grows on sandy or rocky soils, usually on limestone or gypsum in brushlands, plains, rangelands, slopes & hillsides in High Plains, Rolling Plains, Edwards Plateau & Trans Pecos.	Sands, loams & clays, either gypseous or calcareous soils. Well-drained, xeric.								X	X	X	X	Copper mallow performs very well in cultivation. Columns of pale orange blossoms are set off by attractive soft grayish-green foliage. Blooms for a long period of time weather permitting. Fairly drought-tolerant. Perennial.	Copper mallow is readily browsed by Mule deer & other herbivores. Bees, butterflies & other nectar & pollen loving insects are attracted to the flowers. Ripe seeds are eaten by seed-eating birds & small mammals. LHP of Common checkered skipper.
<i>Amblyolepis setigera</i> Huisachedaisy	Asteraceae Sunflower Family	Wildflower 6" - 18"	Showy golden yellow daisy-like flowers. April - June	Achenes, June - Aug.	Full sun, part shade	Grows in fields, meadows, prairies throughout the western portion of the state.	Sands, loams, caliche-type soils. Well-drained, xeric.								X	X	X	X	Huisache daisy is a few-branched attractive yellow-flowered plant with a two-toned daisy like flower. Looks great in a meadow where it will bloom profusely for over two months. Annual.	Bees, butterflies & other small insects are attracted to flowers. Ripe achenes are eaten by many species of small seed-eating birds.
<i>Argemone albiflora v. texana</i> White prickly poppy	Papaveraceae Poppy Family	Wildflower 1'-2'	Showy crepe-paper like white flowers. March - June	Capsules with seeds. May - Aug.	Full sun, part shade, dappled shade	Grows in open fields, meadows, prairies, along roadsides throughout most of Texas.	Sands, loams, clays, limestone-based & caliche-type soils. Well-drained, xeric.	X	X	X	X	X	X	X	X	X	X	X	White prickly poppy is a very striking white flowered plant with plenty of prickles on the stems & leaves. A highly drought-tolerant plant, it will look good when everything else is sere & brown. It prefers full sun to shady areas. Annual.	Several varieties of insects forage on the pollen & nectar of this plant, especially bees & beetles. Deer don't browse this plant due to the prickles.
<i>Gaillardia pulchella</i> Indian blanket	Asteraceae Sunflower Family	Wildflower 1'	Showy yellow & red daisy-like flowers. March - Oct.	Achenes. May - Nov	Full sun, part shade	Prefers open grassy areas, prairies, meadows, also disturbed areas in a variety of soils	Sands, loams & clays. Well-drained, mesic-xeric.	X	X	X	X	X	X	X	X	X	X	X	This is a marvelously easy wildflower to grow & it comes in various coloration patters from mainly yellow to mostly reddish. Blooms most of the season from spring to late fall & provides lots of color to a wildflower meadow. Annual.	Indian blanket attracts bees, butterflies & several other varieties of small insects who forage on the nectar. Ripe seed heads are favorites with many species of seed-eating passerines like the Painted Bunting.

<i>Hymenopappus flavescens</i> Yellow plainsman	Asteraceae Sunflower Family	Wildflower 1' - 3'	Showy yellow flower heads. May - Sept.	Achenes July - Nov.	Full sun, part shade	Grows in open fields, meadows & plains in the High Plains & the Rolling Plains.	Sands & loams. Well-drained, xeric.										X	X	Very striking deep yellow wildflower with pale gray-green leaves which are furry on the underside. These plants look great in a wildflower meadow. Yellow plainsman is quite drought-tolerant & needs no extra watering. Biennial.	Bees, butterflies & other nectar-loving insects spend a great deal of time foraging atop these flowerheads which serve as landing platforms. What seed does not serve as food for granivorous birds will self sow for the next year.	
<i>Lepidium montanum</i> Mountain peppergrass	Brassicaceae Mustard Family	Wildflower 1' - 2'	Showy white flowers. March - June	Silicles. May - Aug.	Full sun, part shade	Grows in sandy, calcareous or saline soils in open areas, deserts, brushlands, rangelands & openings on cedar slopes in Panhandle & southwest Texas.	Sands, loams, limestone-based & caliche-type soils. Well-drained, xeric.										X	X	X	These low dense plants are spectacular when in bloom. Works well with clumps placed near rocks or used as a border. It prefers full sun with well-drained soils. Flowers are open only in the morning. Biennial.	Bees, butterflies & other small nectar-loving insects attend the mounds of white flowers in the morning. Larval host plant of the Checkered white butterfly.
<i>Linum lewisii</i> Blue flax	Linaceae Flax Family	Wildflower 1' - 2'	Showy blue flowers with 5 petals. April - Oct.	Capsule with flat oily seeds. June - Nov.	Full sun, part shade	Grows in sandy rocky soils on slopes in Panhandle and Trans-Pecos.	Sands, loams, clays, limestone-based & caliche-type soils. Well-drained, xeric.										X	X	Blue flax appreciates well-drained soils and produces a profusion of beautiful blue flowers. Does well in a meadow garden or pocket prairie. Annual.	Blue flax attracts bees, butterflies & other small insects.	
<i>Machaeranthera tanacetifolia</i> Tahoka daisy	Asteraceae Sunflower Family	Wildflower 6" - 12"	Showy magenta daisy-like flowers with yellow centers. March - May	Achenes May - July	Full sun, part shade	Occurs on gravelly soil flatlands, fields, prairies in the Rolling Plains, High Plains & the Trans-Pecos.	Sands, loams, clays & caliche-type soils. Well-drained, xeric.										X	X	This absolutely beautiful wildflower produces thick continuous blossoms for about two months before they fade. These plants work well in a shortgrass meadow or on a rocky hillside. The plant also does well in a rock garden. Good drainage. Annual.	Tahoka daisy attracts many small bees, butterflies & other insects that are attracted to the nectar. Ripe achenes are sought after by several species of seed-eating birds.	
<i>Verbena bipinnatifida</i> Prairie verbena	Verbenaceae Vervain Family	Wildflower 6" - 12"	Showy magenta to purple flowers grouped in 2"-flower heads. March - Dec.	Capsule-like fruit, dry (Schizocarp) May - Dec.	Full sun, some shade O.K.	Prefers prairies & fields throughout most of Texas, except for Trans-Pecos	Sands, loams, clays & limestone-based soils. Well-drained, mesic-xeric.	X	X	X	X	X	X	X	X	X	X	X	Prairie verbena makes a great low-growing ground cover. Looks very good in rock gardens. Prefers full sun & limestone soils but will survive in others. Annual.T107	Prairie vervain is an excellent butterfly plant. When in bloom it is always attended by them as they daintily park on the conveniently shaped landing-platform-shaped flower heads.	

## APPENDIX Z

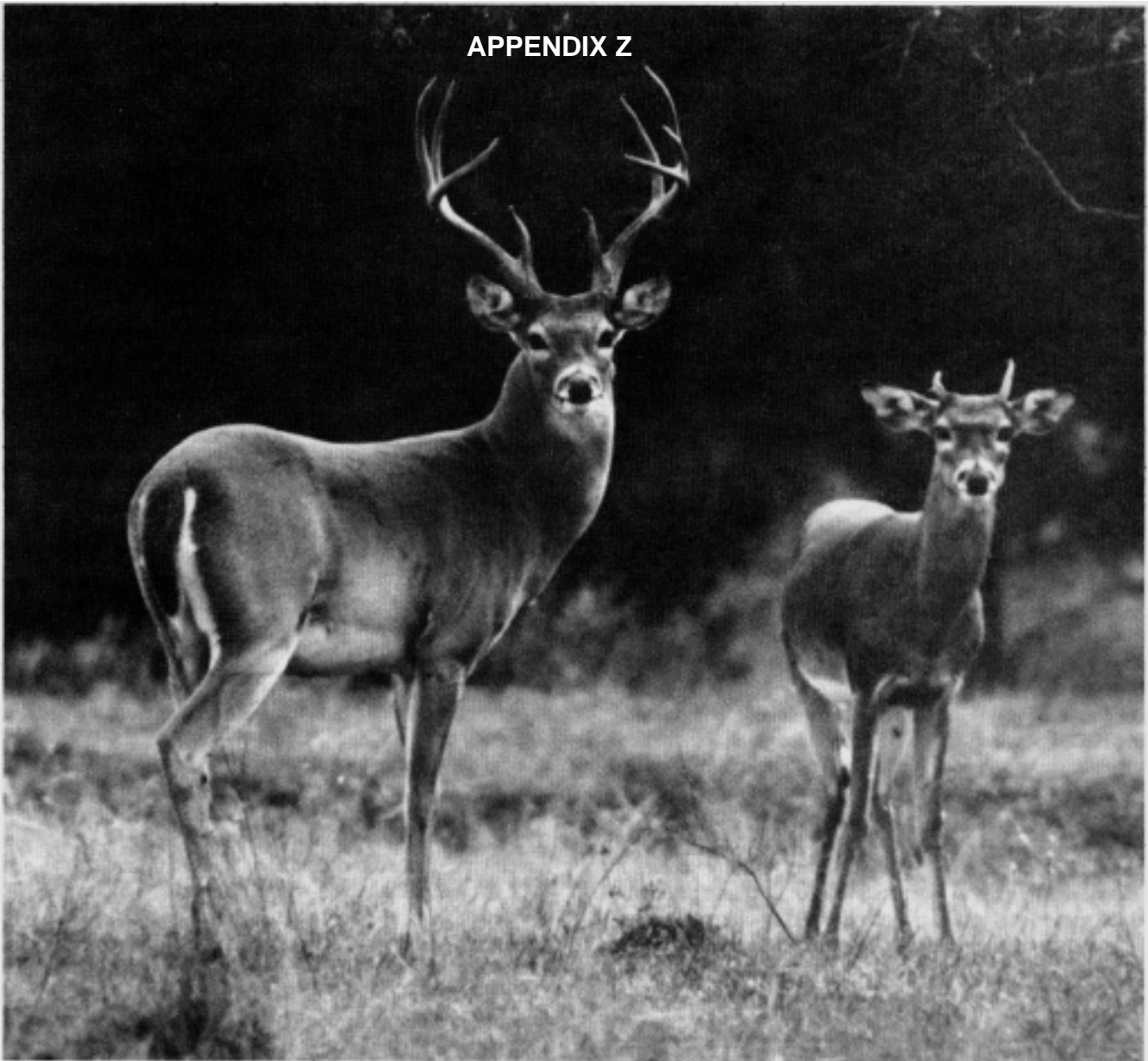

# Learn About Whitetails

by Robert L. Cook

Updated and revised by Horace G. Gore, 1989

From *Texas Parks and Wildlife Magazine*

October 1975

Exploration and settlement of the American frontier would have been extremely difficult without the white-tailed deer. Early colonists and explorers utilized the meat and skins of these animals extensively, and deer hides later served as a medium of exchange between trappers, frontier scouts, Indians and traders.

Deer were even more important to the American Indians prior to settlement of the nation, providing clothing and food. Deer were also an important factor in the folklore and religion of native tribesmen.

Indiscriminate slaughter by commercial meat and hide hunters and ignorance of the deer's habitat requirements almost caused its extermination near the end of the 19th century. It was reported, for example, that an early Texas trader operating in Indian country at Trading House Creek (near present site of Waco) shipped approximately 75,000 deer skins from 1844 through 1853.

Public concern for survival of the species brought about a series of protective measures by the Texas Legislature near the turn of the century. A five-month closed season during

which deer could not be hunted was enacted in 1881. The bag limit was established at six bucks per season in 1903 and was reduced to three bucks per season in 1907.

The first hunting licenses were sold in Texas in 1909. In 1919, six game wardens were hired to patrol the entire state.

Additional interest and protection by landowners, sportsmen and law enforcement personnel helped deer populations increase steadily during the 1930s and 1940s. Statewide trapping and restocking programs established deer herds in previously uninhabited areas. Sales of hunting licenses increased dramatically—382,249 in 1955, 571,058 in 1964 and over one million in 1972.

The white-tailed deer is now the most numerous big game animal in Texas and in the United States. Aesthetically and emotionally, the whitetail holds a place of distinction in the hearts and minds of many Texans.

Research and management projects concerning the whitetail and its habitat requirements are conducted by wildlife biologists of the Texas Parks and Wildlife Department, federal agencies, many universities and several private research establishments in Texas.

Research activities by the wildlife biologists of the Texas Parks and Wildlife Department are 75 percent funded from federal excise taxes on firearms and ammunition. Deer are of primary importance on several of the 119 wildlife management areas (900,000 acres) operated by this department. Research activities also are conducted on National Wildlife Refuges, National Forests and Department of Defense lands. The Texas Parks and Wildlife Department game warden field force now numbers some 460 officers. These highly skilled and trained officers provide law enforcement services essential to continued survival of the whitetail.

The whitetail is one of the most researched, observed, sought after, cussed and discussed of all wildlife species in Texas. Few of us, however, are aware of the basic principles which rule this majestic animal's life. Following are some of the most frequently asked questions about white-tailed deer in Texas.

#### How many kinds of deer are there in Texas?

The Texas white-tailed deer, *Odocoileus virginianus texana*, occurs almost statewide. There were several subspecies of whitetail in the state years ago. However, due to expanding-overlapping ranges and restocking efforts in recent times, the subtle differences between subspecies have been lost except for the isolated population of Carmen Mountain white-tailed deer, *Odocoileus virginianus carminus*, in the Big Bend National Park area. Although found almost statewide in brushy or wooded areas, the heaviest deer populations are located in the central one-third of the state. The mule deer, *Odocoileus hemionus*, is a different species which occurs primarily west of the Pecos River and in parts of the High Plains of the Texas Panhandle.

#### How many deer are there in Texas?

Texas has more white-tailed deer than any other state. Population estimates in recent years range from three to four million. Current census data indicate that there are more than

four million whitetails in Texas. Population estimates vary from year to year, depending upon reproduction, survival and losses due to malnutrition and disease.

#### How many white-tailed deer are legally harvested by sportsmen in Texas each year?

An estimated 500,000 whitetails are harvested by sportsmen in Texas annually—more than any other state.

#### Isn't that too many?

No. Current harvest rates account for only about ten percent of the herd annually. Research indicates that about 20 percent of most populations should be removed annually by sportsmen. Biologically sound harvest rates and habitat management programs are necessary in Texas to prevent waste due to overpopulation, to achieve maximum utilization of this valuable natural resource and to insure the whitetail's continued survival. For example, since the initiation of the program in 1953, more than two million antlerless or doe deer have been harvested from the established deer herds in the state.

#### How are deer counted?

Several methods of estimating deer numbers are used in Texas:

1. The walking deer cruise line. During the fall months, wildlife biologists walk census lines which have been placed in representative deer habitat and count the deer observed. This method is used extensively in Texas, and there are several hundred such deer census lines in the state.

2. Counts from fixed-winged aircraft. This method is used in areas of the South Texas brush country. Observers count deer seen on strips of deer habitat of known width and length.

3. Track count method. Counting deer tracks on selected sites during late summer is a method frequently used in heavily wooded areas of East Texas.

4. Spotlight counts. Counting deer at night with the use of spotlights along pasture roads or lightly traveled public roads is a method biologists have recently put into use. It is an excellent census method in areas with low deer populations. **Caution:** Biologists always notify all landowners along their spotlight census routes. They drive vehicles clearly marked "Texas Parks and Wildlife Department" and "Deer Census." Any other spotlighters should be reported to the local game warden.

5. Several other deer census methods are used by Parks and Wildlife Department personnel. Counts from helicopters and late evening counts from vehicles are good deer census techniques.

#### What do deer eat?

Deer eat mostly browse (leaves, twigs, young shoots of woody plants and vines) and forbs (weeds and other broad-leaved flowering plants). They eat some grass, but only when



*Each summer the whitetail grows a new set of antlers. When the breeding season begins, the velvet (above) is shed and the antlers become hard and polished.*

it is green and succulent. Sheep, goats and foreign big game species compete directly with the whitetail for preferred deer foods. Deer food shortages usually occur during late summer and winter months. Adequate forage is usually available during spring and fall seasons. A variety of foods and habitat types is essential to good deer production and survival.

The following plants are examples of some good native deer foods in Texas which are readily taken by deer when and where they are available.

*Browse:* oak leaves and acorns, yaupon, greenbriar, prickly pear and fruit, hackberry, mulberry, rattan or supplejack, sumac, mesquite beans and dried leaves, hawthorns, poison oak, American beautyberry, wild cherry and plum, wild grape, honeysuckle, dogwood, elm, blackberry and dewberry, gum elastic (chittum), acacias (catclaw), ephedra, walnut, guayacan, wild chinaberry, kidneywood, Brasil and other condalias.

*Grasses:* rescue grass, Texas wintergrass, Ozarkgrass, fall witchgrass, panic grasses, sedges and rushes.

*Forbs:* bundle flower, euphorbia(s), whorled nodviolet, bayflower, oxalis, wooleywhite, tickclovers, filaree, clover, verbena, arrowleaf sida, wild lettuce, wild onions, old man's beard, wildbean, snoutbean, lespedezas, spiderwort, vetches (milkveitch, etc.) lamb's quarters, plantain, groundcherry, pigweed or carelessweed and partridge peas.

#### How long do deer live?

Deer in controlled situations have been known to live 15 to 20 years. It is unusual, however, for a deer in the wild to live more than 10 years, because its teeth usually wear out during the eighth or ninth year.

#### How can the age of a deer be determined? Is the number of antler points one method?

Deer age is determined by tooth replacement and tooth wear of the premolars and molars (back teeth) of the lower jaw. Unlike sheep, deer cannot be aged by their front teeth, and age cannot be determined by antler characteristics.

#### Does a buck deer keep the same set of antlers each year?

No. A buck grows a new set of antlers (not horns) each summer. The size of the antlers depends primarily upon the quality and quantity of food the buck eats and his age. The more nutritious the food and the more there is of it during the antler-growing season, the better his antlers will be. With favorable conditions, antler size and spread will increase with deer age. After the sixth year, however, antlers usually decline in size due to the deer's inability to properly chew and digest food.



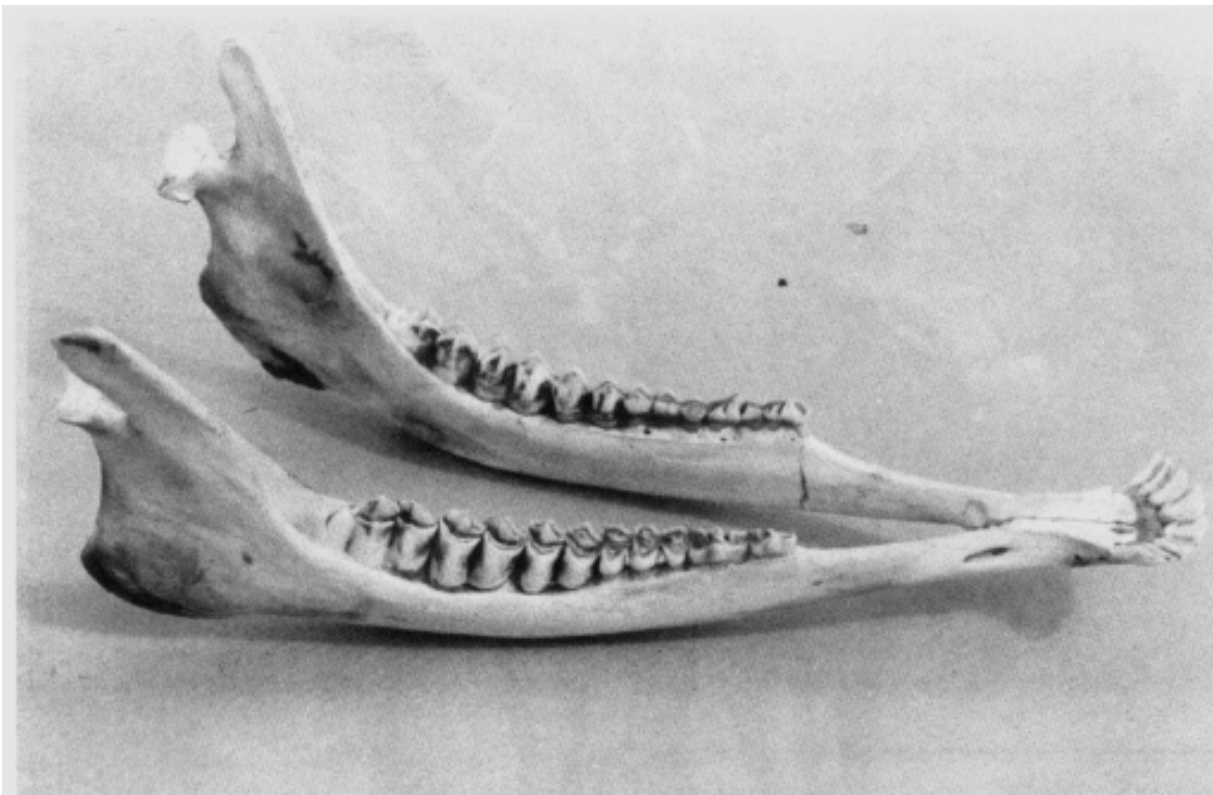

*By noting tooth replacement and tooth wear of the premolars and molars of the lower jaw, biologists determined that this deer was 1½ years old.*

#### What happens to the antlers each year?

Buck deer shed their antlers following the mating season each year. Antler shedding is triggered by the cessation of production of a hormone which also terminates the breeding season. Most bucks in Texas shed their antlers during late January and February. Shed antlers quickly deteriorate or are eaten by rodents and other animals for their calcium content. New antlers start growing and become noticeable "in velvet" during May and June. Good nutrition during this period is critical for good antler growth.

#### Shouldn't spike bucks be protected since they are young and will be the breeding bucks of the future?

Not necessarily. Most spike bucks are young deer, but if range conditions are poor, there may be spikes of any age. If a herd contains many spikes, the deer probably did not have sufficient quality forage during antler-growing season (May-August). It would serve no logical purpose to protect the spike buck. Research conducted on the Kerr Wildlife Area has shown that all young spike bucks do not develop into the same quality of buck as do most yearling bucks with forked antlers. Some young spikes will produce very good antlers later in life, but the chances for massive antlers is not as good as with forked antlered yearlings. Spikes should be harvested based on the intensity of management desired by each landowner or group of hunters. Spikes should never be protected from hunting. The idea that the removal of spikes is a cure-all for antler development has little merit.

#### When is the breeding season?

The breeding season for white-tailed deer in Texas ranges through the fall and winter months from about the first of September through mid-January. The peak breeding activity occurs in mid-November in Central Texas and late December in South Texas.

#### What is a good buck-doe ratio?

The buck-doe ratio in most of Texas is about one buck per three to five does (adult deer) which is satisfactory for good production and hunting. This ratio is not a major problem in Texas deer herd management at this time. An adequate harvest of antlerless deer would help maintain a good ratio of both sexes. It is recommended that game managers and landowners strive for a ratio of 2.5 does per buck.

#### Won't the deer become smaller due to inbreeding if we don't bring some new blood lines?

No. The deer of Texas are direct descendants of isolated deer herds of many years ago. Inbreeding may occur in the wild, but it apparently is no problem. New blood lines are quickly absorbed into established genetic pools and no improvement in quality is noticed. Inferior quality or small deer result from poor range conditions or insufficient preferred forage and will not be improved by bringing in new bucks.

### Does the Texas Parks and Wildlife Department restock deer?

Yes, but only in approved areas judged as potentially good deer habitat which presently have few or no deer. The deer trapping and restocking program was initiated in 1938 by the Game, Fish and Oyster Commission, predecessor of the Texas Parks and Wildlife Department. Since that time, more than 30,000 deer have been released in 160 Texas counties.

### How many fawns will a doe have?

Normally, a doe deer in Texas will have her first fawn, which is usually a single, when she is two years old. Thereafter, if food conditions are adequate, the doe should normally have twin fawns almost every year until her sixth or seventh year, when the reproductive rate will begin to decline. Triplet fawns are uncommon, but do occur. Quadruplets have been reported.

The gestation period for deer is seven months.

According to reproductive studies, "old barren does," or does that have never produced fawns, are uncommon and are no problem to deer herd management. The key to maximum production is an adequate supply of nutritious natural food.

### Are more female fawns born than male fawns?

No. Male and female fawns are born in approximately equal numbers.

### What are the most serious threats to deer herds in Texas?

1. Habitat destruction such as land clearing, root plowing, improved grass pastures, subdivisions, new lakes, expanding cities, etc.
2. Poor range or inadequate food supplies due to overgrazing by domestic livestock and overpopulations of deer, resulting in large-scale deer die-offs.
3. Disease and parasites.
4. Illegal hunting.

### What are some of the most important limiting factors affecting white-tailed deer?

Rainfall is an important limiting factor. Extended periods of severe drought during the late summer and fall are especially harmful to fawns, yearlings and very old deer. Coyotes are a limiting factor in South Texas and in portions of Southeast-Central Texas. However, natural predators, such as coyotes, bobcats or eagles presently pose no serious threats to established deer herds of Texas. Efforts to control these predators are usually expensive and ineffective with regard to white-tailed deer.

### What about hunting?

Legal hunting can be a limiting factor but is not currently a threat to deer populations. In fact, regulated hunting is the best way to crop the deer herd annually, much like a farmer-rancher would crop his herds of domestic livestock. Properly controlled and regulated, hunting is the most reasonable and humane method of maintaining and utilizing the extensive deer populations of Texas.

### Will deer move great distances?

Not normally. A deer chased by dogs may run several miles, but will often circle and end up close to home. During the breeding season, some bucks will trail female deer out of their normal home range but will later return. Movement studies and radio-tracking research in Texas indicated that most deer spend their lives within about 1.5 miles of their birthplace.

### What can I do to help the deer, increase deer numbers or improve the quality of deer?

1. Learn about the habitat requirements of deer. Become familiar with preferred deer foods in your area or the area where you vacation or hunt. Support practices which create good wildlife habitat and prevent destruction of existing habitat.
2. Landowners and operators should make every effort to provide adequate habitat and forage for deer and other wildlife. Competition by domestic sheep and goats should be reduced in some cases. Both sexes of deer should be reasonably, but adequately, harvested each year from well-established herds.
3. Sportsmen should obey state laws and those rules established by landowners. Sportsmen should not abuse the land on which they hunt, trespass where they do not have permission, take "sound shots" or misuse a firearm.
4. Everyone should cooperate with law enforcement officers responsible for protection of our wildlife. Violations should be reported immediately to the nearest game warden of the Parks and Wildlife Department, or to Operation Game Thief at 1-800-792-GAME.
5. Landowners and hunters can provide a significant service to the game management programs of Texas by completely and accurately providing harvest data. Whether it is solicited by mail questionnaire or in person by biologists in the field, at check stations or cold storage facilities, valid harvest information is vital to the formulation of effective hunting regulations. These regulations will allow the maximum harvest of surplus animals without endangering the broodstock necessary to replenish those populations.

### Would it help to feed the deer some supplemental feed?

If deer take large quantities of supplemental feed (corn, etc.), there probably is a shortage of their natural preferred foods. The best solution to the problem is to improve availability of natural foods. Obviously, this cannot be achieved quickly and will result only from proper range management practices (grazing moderately, rotation grazing systems, etc.). If artificial feeding is necessary, deer should be supplied high-quality (14 to 16 percent protein) 3/16" pellets instead of corn, which is about eight percent protein. Marked improvement in body size and antler development should not be expected from artificial or supplemental feeding.

Researchers in Texas and other states have worked many years to obtain answers to some of the many questions concerning the white-tailed deer, its requirements and management. Continued research will reveal additional necessary information about this and other wildlife species. The well-being and continued survival of the whitetail in Texas, however, is dependent primarily upon the interest and concern of sportsmen, landowners and the conservation-minded public of our state.

# How To Age Deer

## GENERAL ANATOMY OF LOWER MOLAR

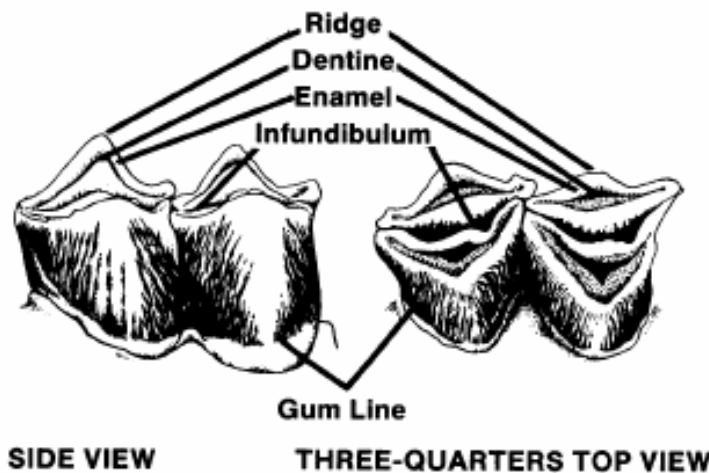

Age of a deer is determined by tooth replacement and wear on molars and premolars of the lower jaw. As a deer grows older, certain portions of its teeth are worn enough to show definite differences from the teeth of other age classes.

A deer has only six jaw teeth, although they appear to have many more. The teeth are broken into two distinct categories: the premolars, which are numbered 1, 2, and 3, and the molars, which are numbered 4, 5, and 6.

Deer are aged in fractions because they are born around July and are killed during the hunting season.

**1½ year old:** (*long yearling*): The long yearling deer is the most easily recognized of all age classes. The first three jaw teeth are milk teeth, which will be replaced around two years of age. These are worn smooth as a long yearling, while the last three teeth remain sharp. The number 3 tooth has three cusps in the milk tooth stage, but only two cusps appear on the replaced tooth. Fawns in their first season will show little evidence of wear on their milk teeth.

**2½ year old:** The first three jaw teeth have been replaced by permanent teeth and all molars are sharp. The dentine of the first molar (tooth 4) is not as wide as the enamel which surrounds it.

**3½ year old:** The dentine in the first molar (tooth 4) is now as wide or wider than the enamel which surrounds it, and this is not true of the second molar or tooth 5.

**4½ year old:** The dentine of the first and second molars (teeth 4 and 5) is as wide or wider on both teeth, but not in tooth 6.

**5½ year old:** The dentine of all molars (teeth 4, 5, and 6) is now as wide or wider than the enamel surrounding it.

**6½ year old:** The first molar (tooth 4) is worn smooth, but teeth 5 and 6 are not smooth.

**7½ year old:** The first and second molars (teeth 4 and 5) are worn smooth, or tooth 5 may still have a small ridge left.

**8½ year old:** All molar teeth are worn smooth (teeth 4, 5, and 6), but tooth 6 may still have a small ridge left.

**Older than 8½ year old:** Unable to determine, because characteristic formations have all been worn smooth.

The primary factor governing antler formation is food supply. As deer grow older and their teeth wear flatter, food becomes harder and harder to chew. Body condition will drop and, simultaneously, so will antler development.



1½



2½

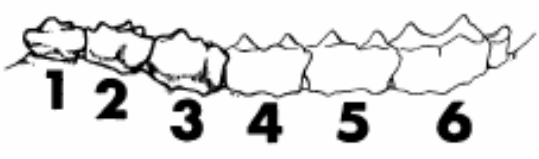

3½



4½



5½



6½



7½

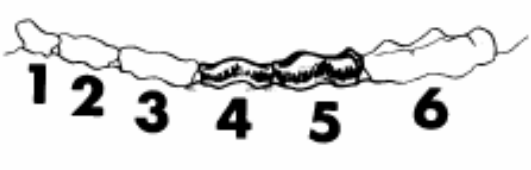

8½

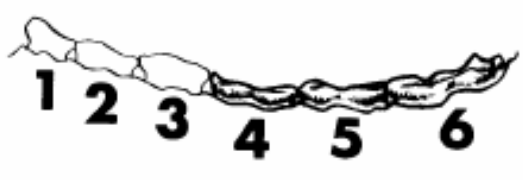

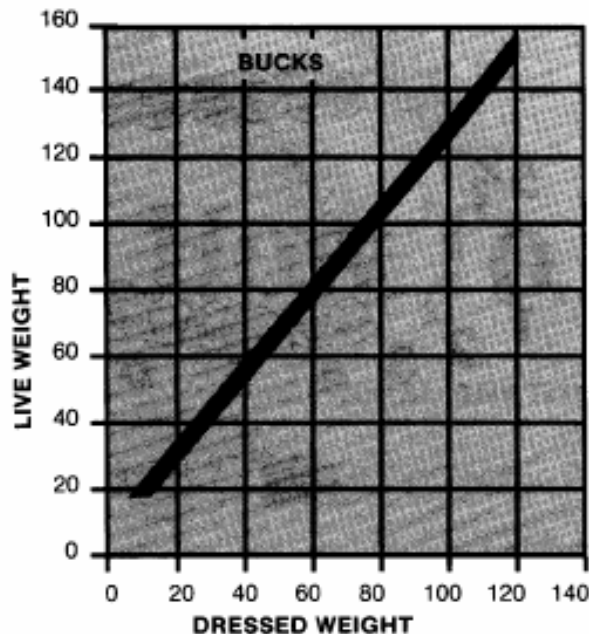

Find dressed weight of buck in figures at bottom of chart and trace line up to diagonal. From intersection, trace line to scale at left and read live weight. Reverse this procedure to determine dressed weight of live animal.

Does are lighter than bucks so a different chart must be used. As above, find dressed weight of doe in scale at bottom, trace up to diagonal, then from intersection trace line to left and read estimated live weight.

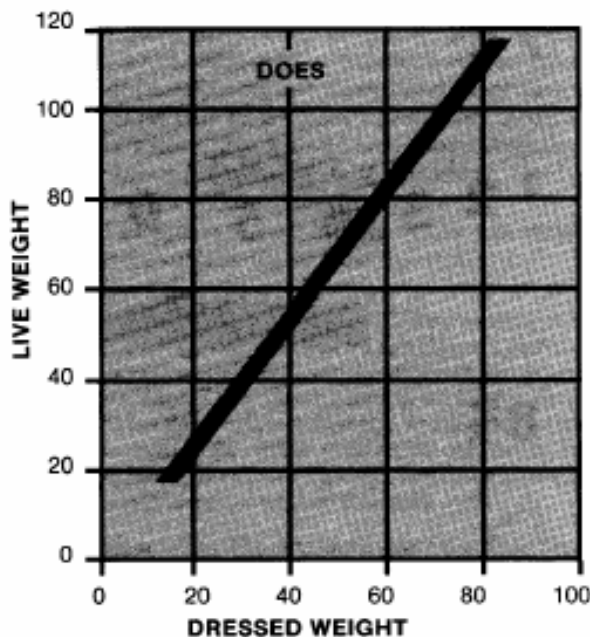

# The Way to Weigh

by Charles Ramsey  
and  
Melvin J. Anderegg

**A** PICKUP with two hunters drove up to the deer check station on the Kerr Wildlife Management Area. Both hunters climbed out, and walked around to the back of the truck and began unloading a couple of deer.

The first deer, a small doe, was tossed upon the table in the check station. Area personnel field dressed the deer and recorded descriptive measurements and weights. Then the doe was loaded back into the truck.

The second deer, a large buck, was lifted onto the table and the process of measuring and recording was repeated. Since the buck was already field dressed, only a dressed weight was taken—106 pounds field dressed. How big was that deer on the hoof?

This question has been repeated so many times at the check station that two graphs were prepared to help with the answer. These graphs represent the weights taken from approximately 200 deer in good body condition killed on the Kerr Wildlife Management Area. Since these deer were typical of the Edwards Plateau, the graphs will be applicable for deer taken within the Hill country. Although not as accurate, they are also good guides for deer taken from other areas of the state.

Dressed weight means "field dressed" with head, hide, and feet left on the carcass.

Visit the outdoors each month through the full-color pages of *Texas Parks & Wildlife* magazine.

To subscribe, call 1-800-792-1112 Monday through Friday between 8 a.m. and 5 p.m.

Rates:

<b>1 year \$10</b>	<b>Foreign 1 year \$12</b>
<b>2 years \$18</b>	<b>Foreign 2 years \$21</b>
<b>3 years \$26</b>	<b>Foreign 3 years \$30</b>

(Domestic rates include APO & FPO)

**TEXAS PARKS & WILDLIFE Magazine**  
4200 Smith School Road  
Austin, Texas 78744

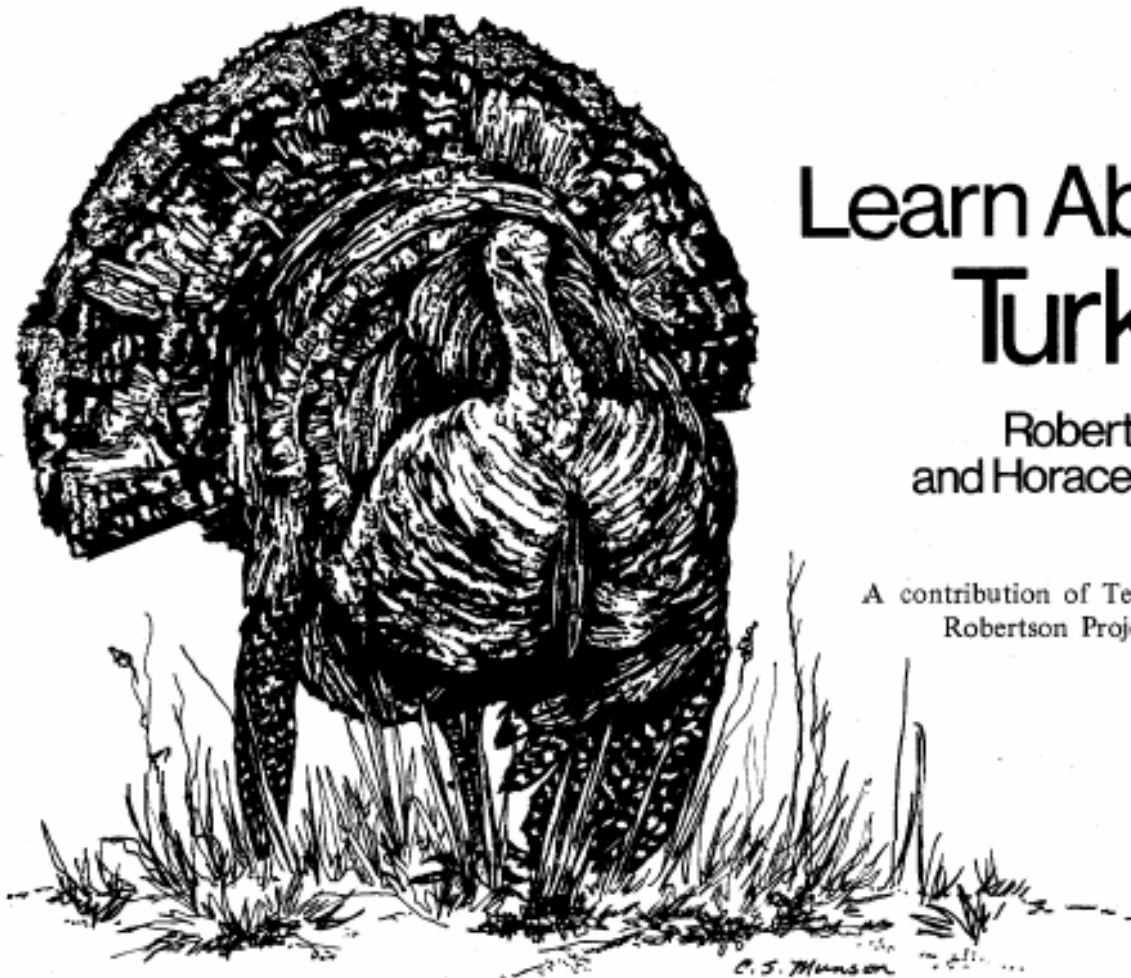

# Learn About Turkey

Robert L. Cook  
and Horace G. Gore

A contribution of Texas Pittman-  
Robertson Project FW-14-C.

Turkey were almost exterminated in Texas by late in the 19th century. However, the first step was taken to protect these game birds in 1897 when trapping was outlawed for five months of the year. In 1903, a bag limit of 25 turkey per day throughout a five-month season was initiated. These liberal restrictions failed to help the turkey in most of its range, since there were few game wardens to enforce the laws.

In 1919, the legislature created a bag limit of three bearded gobblers per season. Increased protection by conservation-minded landowners and additional game wardens in the 1920s helped turkey populations to begin a steady increase. Also, since that time, the Texas Parks and Wildlife Department has trapped over 10,000 turkey and restocked them to suitable habitat throughout the state in an effort to restore the wild turkey to its historic range.

There are presently two varieties of wild turkey common to Texas. The Eastern turkey, *Meleagris gallopavo silvestris*, is found in the forests and dense thickets of East Texas and is rarely seen because of its wariness and scarcity. The Rio Grande turkey, *Meleagris gallopavo intermedia*, is found in most of South, Central and North Texas. The Merriam's turkey, *Meleagris gallopavo merriami*, once roamed the mountains of West Texas, but were extirpated by 1907.

Attempts to restock this turkey have not been successful.

In general, the Eastern turkey is darker and larger than the more common Rio Grande variety. A mature Rio Grande gobbler averages 16 to 18 pounds, while the Eastern bird averages 19 to 21 pounds.

Biologists of the Parks and Wildlife Department are trying to save Texas' Eastern turkey and restore it to its former range. The few remaining birds are carefully protected by game wardens and landowners, and efforts to restock suitable areas with wild-trapped birds are made each year. Efforts are also being made to develop a hybrid turkey which could be satisfactorily established in portions of East Texas.

Following are some of the most often asked questions about wild turkey in Texas.

#### How long do wild turkey live?

Turkey live an average of two to three years; however, upon reaching maturity their life expectancy increases substantially. Most mortality occurs in poults (young-of-the-year) and yearlings. A few birds have been known to live as long as 10 years.

#### Where did the wild turkey come from?

Wild turkey are native to America and probably evolved from pheasantlike ancestors. American Indians ate turkey and

used the feathers to adorn themselves and their weapons. Cortez, the Spanish explorer, found the Aztecs and other Indians in Mexico in possession of domesticated wild turkey in 1519. The explorer Vasco de Gama introduced the wild turkey into Europe.

#### **What do turkey eat?**

Turkey are primarily vegetarians, although they eat many insects, snails and other invertebrates. Major food items during the spring and summer are green grasses and forbs (weeds), buds, flowers, seeds and insects. In the fall and winter, turkey take fruits, most such as pecans and acorns and green forage such as Texas winter grass, oats or wheat, depending upon availability.

#### **How many eggs does a hen usually lay?**

Ten or 11 eggs make up the average clutch laid by each hen, and it takes her about two weeks to lay them. Most eggs are fertile and will hatch upon completion of the 28-day incubation period if not destroyed or unduly disturbed.

#### **Do most of the eggs hatch or does something happen to them before the incubation period is complete?**

Overall nesting success in turkey is similar to that of most ground-nesting birds. About one-third of all eggs laid will eventually hatch. Weather is the main factor limiting Rio Grande turkey nesting success. If there is insufficient ground moisture, the eggs will get too hot and dry during incubation and the embryo will die. Studies indicate that almost one-half of all turkey nests are destroyed by predators. If weather conditions are good, however, a reasonably good turkey hatch can be expected in spite of predators and other limiting factors.

#### **How long do the hen and young stay on the nest?**

The hen and newly hatched poults stay on the nest about one full day. Poults begin to roost in trees at about two weeks of age, but can fly well for short distances at 10 days. During this critical period, predators account for many poult losses. Although a hen may have hatched nine or 10 poults, only two or three may be left at the summer's end.

#### **Can a bearded turkey hen raise young?**

Yes. They (about 15 percent of all Rio Grande hens in Texas have visible beards) are as productive as hens without beards. Beards appear on older hens and increase in size and thickness with age.

#### **Why are some wild turkey gray or even white?**

Gray or white turkey in the wild are usually genetic color aberrancies compared to the well known "black sheep." They are not domestic turkey gone wild or descendants of domestic turkey. White or gray turkey are often wilder than turkey of normal coloration.

#### **What is the most important limiting factor on Rio Grande turkey?**

Weather, especially dry weather in Texas. Droughts lasting several months may cause reductions of up to 50 percent in wild turkey flocks. During dry weather, turkey are weakened by poor forage conditions and are more susceptible to disease, parasites and predators. Most turkey eggs will not hatch in hot, dry weather and the few poults that do hatch must soon have moisture to survive. Sufficient rainfall during the late spring and early summer months is essential to good turkey production and survival.

#### **Wouldn't a good predator control program increase turkey numbers?**

Not necessarily. Wild turkey have survived and reproduced for thousands of years in spite of the presence of every known predator in North America. With good weather and range conditions, turkey have little trouble contending with pressure from predators. In addition, it is expensive and difficult to effectively reduce predator populations.

#### **Why do we hunt turkey?**

Turkey provide thousands of hours of recreation for sportsmen as well as a delicious addition to the menu. Legal hunting pressure has never been a limiting factor on turkey in Texas since less than 10 percent of the entire population is harvested by hunters annually. Turkey can withstand an annual harvest of at least 20 percent of the population. If these birds are not taken by sportsmen during the hunting season, they will eventually die and be wasted.

#### **Shouldn't we protect hens?**

To properly harvest turkey and maintain sex ratios, it is absolutely necessary to harvest both hens and gobblers. Ranchers wouldn't sell only the male offspring from their livestock herds. The same principle applies to turkey since surpluses occur in both sexes. Continual harvest of one sex will create an imbalance in the sex ratio. In addition, turkey hens are difficult to distinguish from young gobblers, and the average hunter finds it almost impossible to distinguish a bearded hen from a gobbler. As in the case with most game birds (waterfowl, quail, dove), it is practical to allow and encourage the harvest of both sexes. A reasonable either-sex harvest will not hinder turkey production.

#### **Why hunt gobblers in the spring mating season?**

Although the spring gobbler season is relatively new to most Texans, it is traditional in most southern states and is probably the most practical of all hunting seasons, since it is held after the hens have been bred and are laying or incubating eggs. Hunting game animals during their breeding season is a common and established principle to big game hunters. Because of his gobbling and strutting activities, the male turkey is easier to distinguish this time of year. Hunters can also use calls to lure gobblers within range.

Hens need to be bred only once each spring to fertilize their entire clutch of eggs and each dominant gobbler usually mates with about ten hens. Since sexes are born in equal numbers, it is easy to see how a surplus of gobblers can occur under this arrangement. After the hens are bred and no longer need the gobbler for mating, most of the gobblers could be harvested. Bag limit during the spring season in Texas is one gobbler per hunter; therefore, there is no danger of reducing the productivity of the flocks by harvesting gobblers each spring.

#### **Should I try to restock turkey on my place?**

Restocking is one of the most important factors in our turkey management program in Texas, but restocking efforts should not be made in areas that are no longer suitable for the birds. Extensive land clearing practices have eliminated thousands of acres of good turkey habitat, and continuous overgrazing by domestic livestock has rendered additional thousands of acres worthless to the wild turkey. Successful restocking attempts have been made by the Texas Parks and Wildlife Department with turkey trapped from the wild. The

trapped birds are immediately released into approved restocking areas and carefully protected for at least five years following their release. Wild turkey have the ability to survive and reproduce when relocated under such conditions. In most cases, releases of pen-raised or semidomesticated turkey into the wild have been unsuccessful and quite expensive. Releasing pen-raised birds into the wild may also invite serious disease and parasite problems unless done under carefully regulated conditions such as programs carried out by the Parks and Wildlife Department.

There are several factors which should be considered before turkeys are restocked in an area. First, why aren't turkeys there now? Is there sufficient vegetation to provide cover and food? Good turkey range should have ample numbers of mature trees as well as brush and shrubs to provide food (pecans, acorns, berries, seeds) as well as cover and roosting areas. Assuming the range provides all the natural essentials, the area must also be protected from illegal hunting such as roost shooting at night. *No one should be allowed to hunt, camp or otherwise disturb turkey within one-quarter mile of a roost site.* Finally, turkey require a large annual range, often moving eight to 10 miles from winter roost sites to summer nesting areas. Food, cover and protection must, therefore, be provided over an area of several thousand acres. If an area can provide all these essentials and is within the required rainfall belt, then serious consideration might be given the possibility of restocking turkey.

#### **Do turkey need supplemental feed?**

Supplemental feeding of any wild animal is recommended only during extended periods of stress such as prolonged drought or severe winter weather. However, in order to sustain wildlife during these critical periods, the animals must know where the supplemental feed is located and be accustomed to taking it. Therefore, feed should be provided well in advance of any anticipated critical periods. Often supplemental feed is provided just before and during hunting seasons in order to "bait" turkey to a specific site to be harvested by eager hunters. It is essential that such a feeding program be continued into January and February if turkey are going to benefit from it. Turkey prefer natural food and will not take significant quantities of artificial feed unless they really need it. In most cases, it is preferable to improve or extend the turkey's natural habitat and food supply.

Although extended periods of severe weather may justify supplemental feeding in some instances, feeding programs are expensive. Feeding areas should be kept clean and the grain must not become contaminated by the birds' droppings. For this reason, feeders should be moved short distances from time to time. The feeding area should be near trees and thick brush to provide immediate escape cover from predators.

Food plots are preferable to feeding stations for turkey and other wildlife. These plots need not be large in size; two to 10 acres will provide large quantities of forage for turkey and other wildlife if it is not grazed by domestic livestock. Turkey readily eat oats, wheat, clover, vetch or rye.

Biologists in Texas and other states have worked years to obtain answers to some of the many questions which arise concerning the restoration and management of the wild turkey. Our society continues to demand more fields for food

crops; more livestock to provide meat and other products; more lakes for recreational activities; and more land for homes, schools, factories and roads. These demands may spell eventual doom for the wild turkey unless large tracts of land are preserved as wildlife habitat. Continuing research will hopefully provide the management techniques which will ensure the survival of the wild turkey in Texas.

For those landowners and sportsmen who may be interested in feeding turkeys on their land or leases, we have included diagrammatical sketches of two feeders which have proven successful in many areas of Texas. October through March is the critical time for keeping feed available to turkey. Best feeds are milo or corn chops. Landowners who wish to feed both deer and turkey from the same feeder should consider using an elevated barrel-type automatic feeder and a mixture of whole corn and milo.





# Turkey Feeder 500 pound capacity

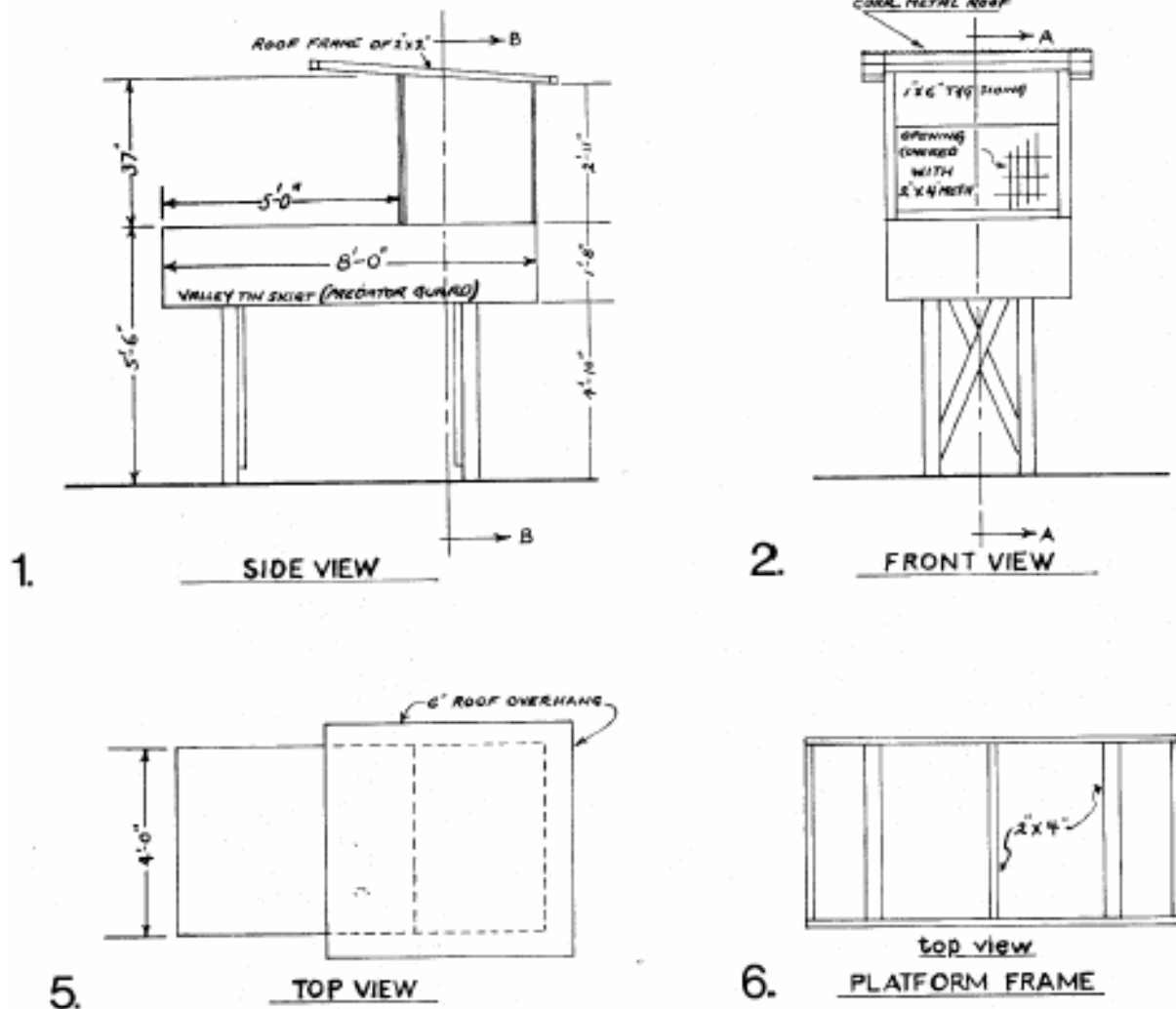

## General Notes

1. Platform Covering & Exterior of Hopper of 1" x 6" T&G
2. "Weldwire" Mesh Used Over Feed Opening
3. Top of Hopper Secured By Hook & Eye at Each Side.
4. T&G Siding on Hopper Installed With Tongue Edge Up.
5. Posts Set in From Edge Of Platform To Deny Access to Predators.

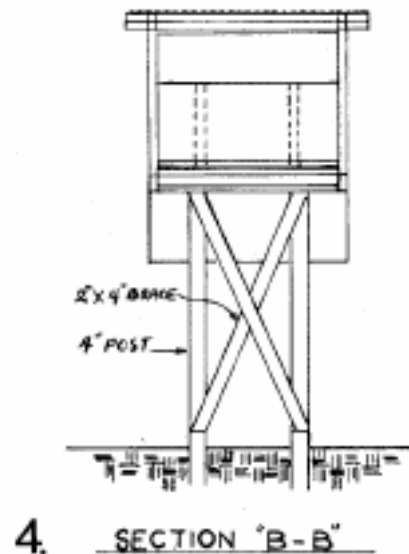
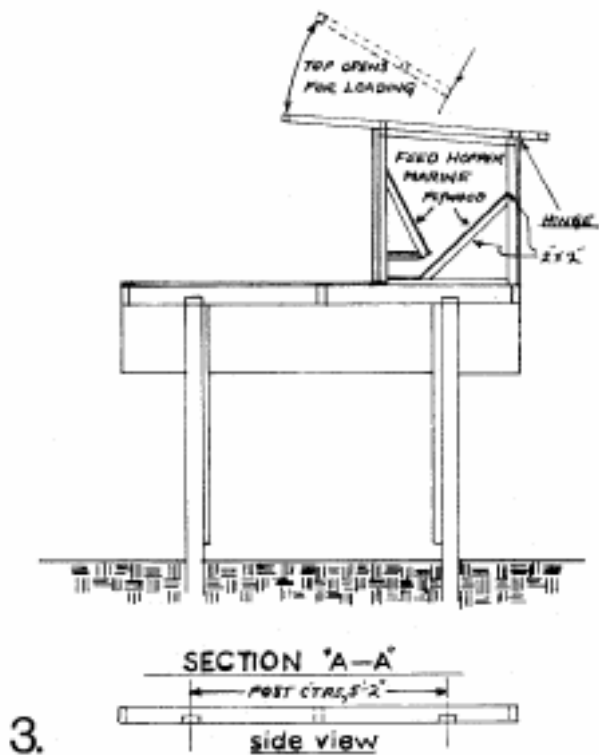

This type of feeder is being used on several wildlife management areas and on private ranches. The inset legs and valley tin around the platform practically eliminates the tremendous waste that usually accompanies the use of turkey feeders by ever-hungry raccoons.

Care should be taken not to place the feeder directly under a tree or the raccoons will soon learn to climb the tree and drop down on the feeder. While it takes a little longer for turkeys to learn to utilize this type of feeder, the savings are well worthwhile. Turkey will normally accept this feeder more readily if a few pounds of grain such as milo are scattered on the ground around the feeder at weekly intervals until turkey locate the feed in the hopper.

The materials to build this feeder cost approximately \$50.00 and if the wood is treated it will last for many years.

REPRINT FROM FLORIDA WILDLIFE MAGAZINE, AUGUST, 1964

# TURKEY FEEDER

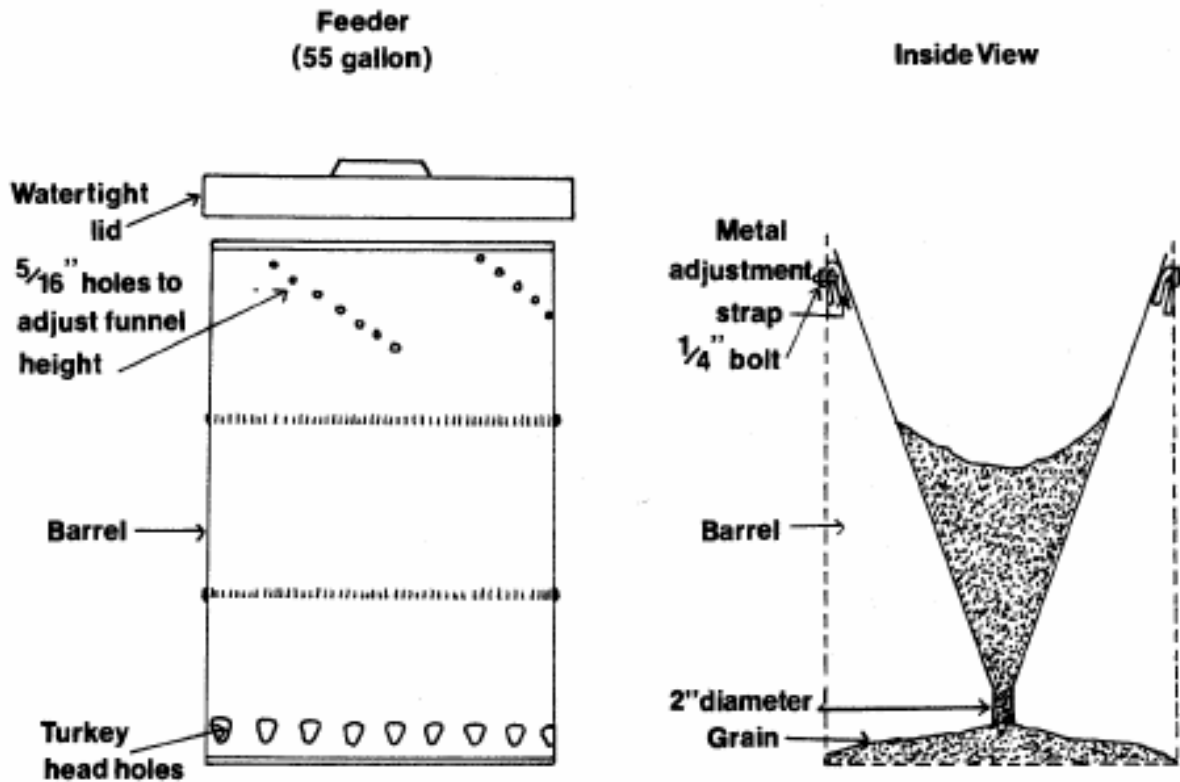

## Turkey Head Holes

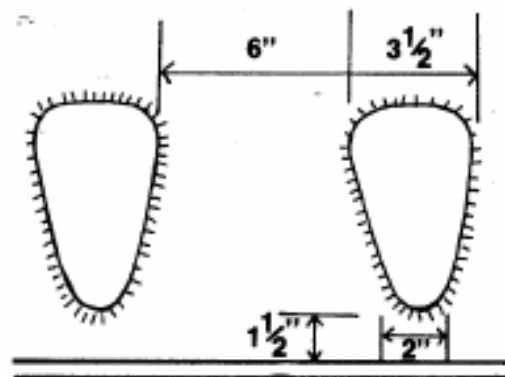

# TURKEY FEEDER PLATFORM

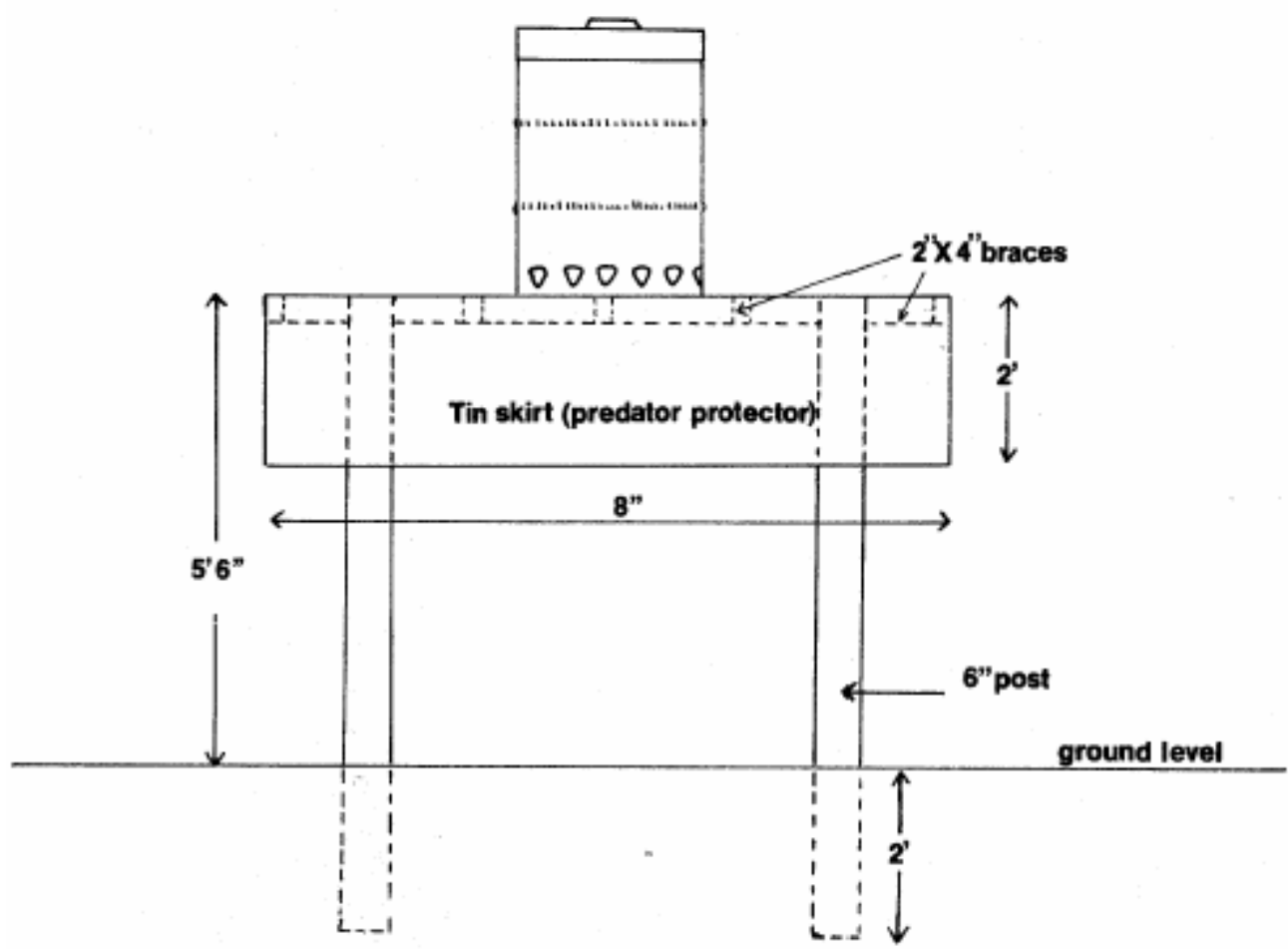

## Visit the outdoors each month through the full-color pages of TEXAS PARKS & WILDLIFE

...a magazine that takes you on an outing 12 times a year. We'll bring you stories on state parks, fishing in our many freshwater lakes and saltwater bays, Texas' abundant wildlife and anything else to do with the outdoors.

It's all illustrated with some of the nation's best color photography, and at a price that's hard to beat.

You can order your subscription by calling us at 1-800-792-1112 Mon. thru Fri., between 8 A.M. and 5 P.M.

### Rates:

1 year \$8  
2 year \$15

Foreign 1 year \$10  
Foreign 2 year \$18

(Domestic rates include APO & FPO)

TEXAS PARKS & WILDLIFE Magazine  
4200 Smith School Rd.  
Austin, Tx. 78744

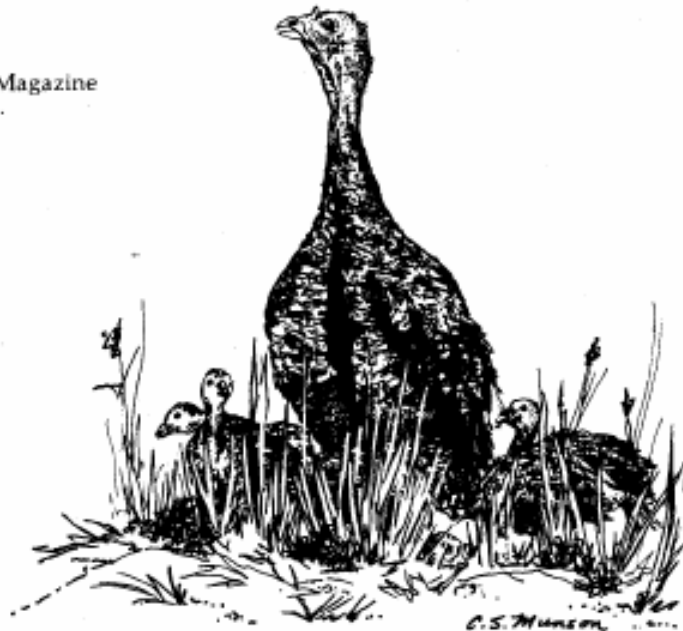

PWD-BK-9000-53-7/84

APPENDIX BB

# BOBWHITE QUAIL

IN TEXAS

Habitat Needs &  
Management Suggestions



by  
**Alfred S. Jackson**  
**Clyde Holt**  
**Daniel W. Lay**



## FOREWORD

Bobwhite quail may be found from the tip of the Panhandle to the mouth of the Rio Grande in Texas, although their principal range is considered to be from the 101st meridian eastward. Within the broad scope of this area, bobwhite's presence and abundance are dependent primarily upon the amount and quality of quail habitat which he can utilize.

Texas has more than a million hunters, and the survey conducted by the Bureau of the Census in 1960 showed that 321,000 quail hunters bagged 98 million birds. Most of these were bobwhites, and certainly this number two small game bird in Texas supplies many hours of recreation and many pounds of meat for Texas outdoorsmen.

Although climatic factors often determine the extent of bobwhite range in Texas, abnormal weather within the range may dictate the conditions upon which bob's yearly survival is dependent. Drought, floods, and other natural causes can reap a heavy toll on bobwhite populations and prove to be devastating where quail habitat is of the marginal variety. Even in high quality areas, these factors may reduce quail populations to a dangerous low. However, bobwhite is a resilient game species and his potential for reproduction permits him to make a speedy recovery, if his basic habitat requirements are maintained.

Food, water and cover are the keys to bobwhite survival. The plants providing these essentials may vary greatly from one portion of the quail range to another. Management requires that

these key plants be recognized, protected, and perhaps encouraged, if bobwhites are to be produced in huntable numbers.

The purpose of this brochure is to acquaint landowners, sportsmen and other bobwhite quail enthusiasts with some specific information which may be used to improve bobwhite's lot through management of quail habitat.

Quail can be produced on land used for the production of timber, ranching or farming, if the land operator will keep in mind that bobwhite's habitat needs must be met the year round. Bobwhite's habitat requirements may be a simple matter of protection of woody cover on prairie range; shallow discing adjoining wide fence rows on an East Texas farm; or some inexpensive food and cover plantings, with protection from grazing, in a South Texas pasture.

Knowledge of quail needs does not in itself insure bobwhite's continued welfare. This knowledge, to be helpful in wildlife management, must be applied to land-use practices found throughout the quail's range.

The basic information contained in this brochure, properly utilized, can help insure to landowners and sportsmen a continued supply of bobwhite quail. Wildlife Biologists and State Wildlife Extension Biologists with the Texas Parks and Wildlife Department are available in each region of the state to assist landowners in preparing management plans for individual tracts of land which could result in increased bobwhite numbers.

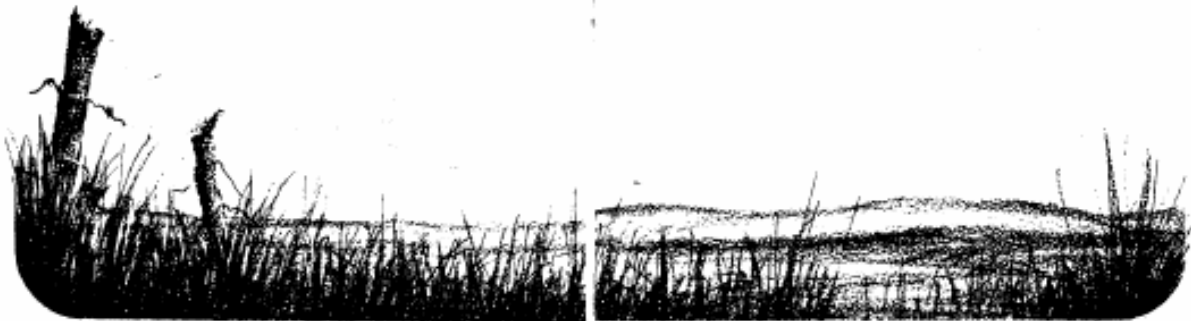

### WHAT IS BOBWHITE QUAIL HABITAT?

Throughout the vastness of Texas, bobwhite habitat varies in character with the differences in soils and climate. Always, whatever the make-up, quail habitat comes down to this: a piece of ground capable of providing at least one covey with all of its life needs, season after season. Bobwhite must have a year-round adequate supply of food and reasonable protection from the hazards to his kind of living. This includes protection from enemies while feeding, resting, loafing, roosting, traveling and nesting.

### QUAIL MANAGER MUST REALIZE EXACTING REQUIREMENTS

The range requirements of bobwhite quail are much more exacting than are those of any kind of domestic livestock. While ranges grazed until



they are bare are readily recognized as unsuited to bobwhites, it is less obvious to most landowners and sportsmen that the other extreme, too much thick grass, can be equally detrimental to quail habitat. The latter can be barren of available quail foods and unsuitable for quail cover.

Food and cover also must occur in a "friendly" relationship to each other if they are to comprise quail habitat. That is to say, the distance between a source of ample food and adequate cover must not be greater than bobwhites can negotiate with safety. Ideally, escape cover should be linked to food supplies with more or less continuous screening cover. The latter must not be dense enough to



prove an obstacle to the bobwhite's short-legged gait. Without a suitable space relationship, a range will not be habitable for bobwhite regardless of the quality or amount of food and cover present.

Both food and cover supply must be stable or continuously renewed during the entire year. It is not enough that food and cover be adequate for 11 months, if either is lacking during a single month. This should be an obvious fact, but it is all too often overlooked during seasonal farm and ranch operations.

### WEEDS ARE ALL IMPORTANT SOURCES OF FALL AND WINTER QUAIL FOOD

Bobwhite nearly always fares well during spring and summer months. Seeds are ripening then and food supply is supplemented by a wealth of insects and green plant material. However, from the time of the first killing frost, the supply of quail food begins to diminish. All fall and winter, other birds and rodents compete with bobwhite for the summer's production of seeds. Weathering also depletes the supply.

Some staple winter foods of bobwhite quail are listed below. These species have wide distribution throughout Texas. The sportsman and landowner would do well to recognize the plants in the field and to determine which seeds are represented in the food of quail bagged during the hunting season. Seeds of some of these plants will almost always be found to predominate in the winter food of bobwhites in any part of Texas.





Doveweed—*Croton* sp.

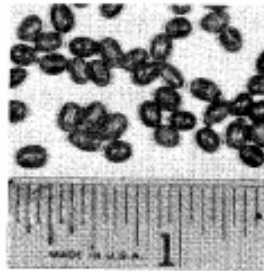

Tick trefoil—*Desmodium* sp.

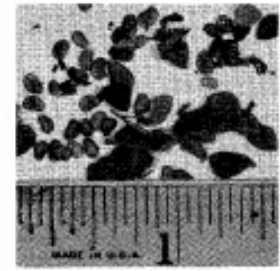

Ragweed—*Ambrosia* sp.

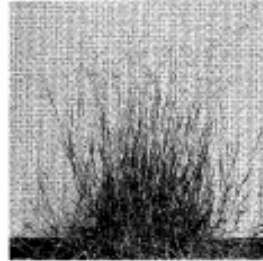
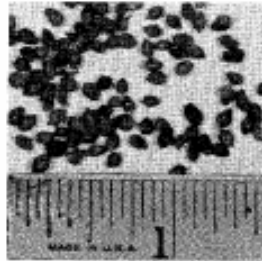

Panic grass—*Panicum* sp.

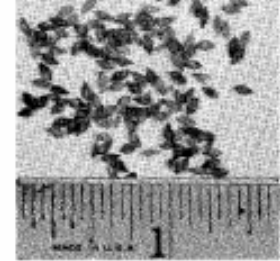

Partridge pea—*Cassia* sp.

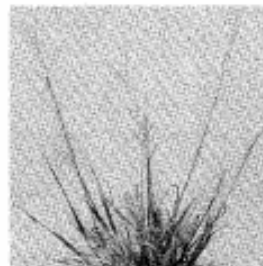

Paspalum—*Paspalum* sp.

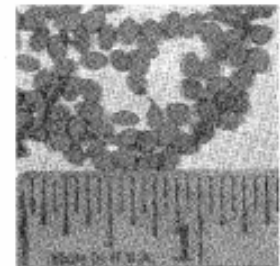

Wild bean—*Strophostyles* sp.

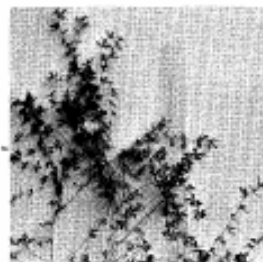
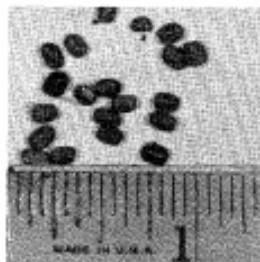

Lespedeza—*Lespedeza* sp.

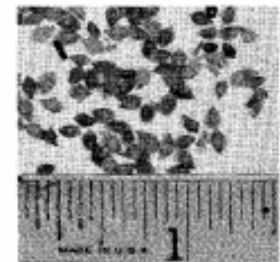

## OTHER BOBWHITE FOODS

The list of plants contributing to the quail's winter diet is a long one. The number of plants represented in a series of quail craws is generally greatest at times when food supplies are critically low. When food is abundant, bobwhites, as do people, tend to eat what they like best and have least trouble finding.

A number of woody plants provide winter quail foods in the various regions of Texas. Quail readily eat the smaller acorns, such as those from post oak. To some degree, they are able to crack the larger acorns and break them into bites which can be swallowed. Mesquite beans, pine seeds, gum



elastic berries, wild grapes, French mulberries, hackberry, sumac berries and other products of woody plants occasionally are eaten by bobwhites.

Stockmen should note that grasses contribute little to food needs of bobwhites. This is because few grass seeds are large enough to provide worthwhile food. Paspalums and panic grasses are minor sources of quail food in the state as a whole, but may be important in some localities.

All farm grown grains, including corn, are acceptable to bobwhites. Where grain is left in the field, bobwhites can be expected to utilize it to an extent controlled by the cover pattern of fence rows and pasture edges.

In general, however, it can be safely said that weeds are the most widely distributed source of quail food and weeds respond most reliably to management of quail habitat.

## FUNCTIONS OF COVER

The bobwhite cannot live long without cover, just as he cannot live without food. In a sense, the bobwhite's need for cover is a specialized one. However, because the uses and functions of different types of quail cover overlap to some degree, and because external factors such as weather, predation and hunting pressure are variable, bobwhite can adjust somewhat better to cover deficiency than to a shortage of food. So far, no one has been able to draw an exact line where the habitat becomes immediately untenable because of too little or too much cover.

On the other hand, bobwhites may endure a shortage of cover for a time, but the population trend will be downward unless cover deficiency is quickly corrected. The quail manager must aim not only at good cover; he must insure that the cover will not deteriorate under influence of winter storms or livestock use. As pointed out earlier, a month of cover failure can be as disastrous to a covey as can a 12-month lack.

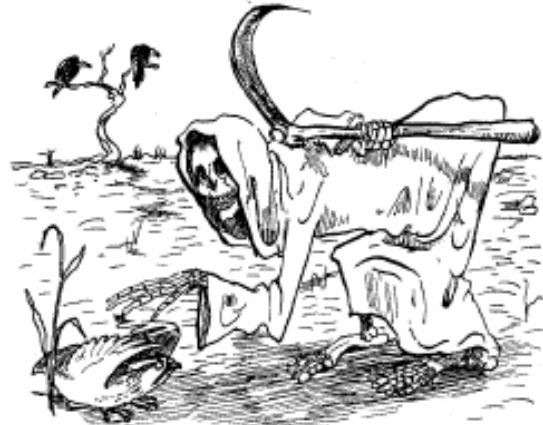

Bobwhites need these types of cover: screening overhead cover for security while feeding and traveling, woody "tangled" cover to which the bobwhite can resort for immediate escape from an

enemy, a "living room" type of cover for dusting or resting, and nesting cover. Roosting cover is also needed; however, if the other types are present it is almost certain that roosting conditions will be no problem. Bobwhites roost on the ground, in grassy or weedy glades, in old reverting fields, on grassy hillsides and in openings in timbered areas. The location of roosts is partly a matter of weather and partly of choosing a site where food will be nearby for the early morning feeding period.

#### BOBWHITE COVER TAKES MANY FORMS

Types of cover having the above requisites are difficult to describe because each may have the qualities needed, yet vary in composition under influences of soils, climates and land uses. Thus, in the upper Panhandle sandhills, excellent cover may consist of sagebrush and tall grasses (feeding, roosting, nesting) and sumac and wild plum motts (escape, resting, dusting).

At the other side of the state, motts of mesquite, granjeno, guajillo, black brush, white brush or prickly pear may serve the needs for woody cover in grasslands.

On the West Texas Rolling Plains, mesquite brush is the principal woody cover. To serve as stable and safe woody cover, it must be bolstered at ground level by a stand of herbaceous cover. The tree itself is too open but, under conservative range use, it often serves as a living fence to discourage grazing and protect the needed understory of weeds and grasses.

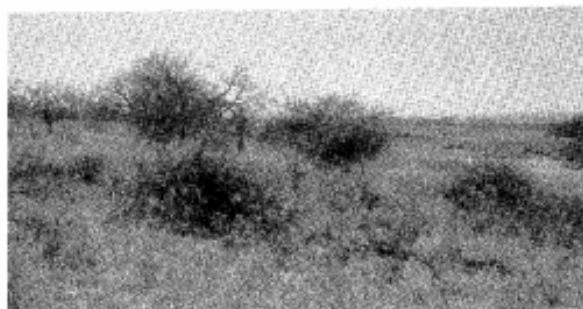

The Grand Prairie of central Texas is threaded with countless creeks whose normally dry tributaries finger out into grasslands and offer examples of almost ideal bobwhite cover; trees, thickets, motts and travel lanes of low bushes and vines form cover patterns of infinite variety.

Eastward, where rainfall is greater, quail cover becomes less of a problem. In forest edges, field fence rows and pasture margins, examples of good quail cover in abundance still can be found. In this part of Texas some of the more important cover plants are yaupon, wild grapes, rattan, wild plums, sumacs, blackberry and greenbrier. In general, the absence of cover is not a problem to the quail manager in east Texas. The problem lies in preservation of cover in a proper spatial relationship to natural foods.

In the Rolling Plains, a continuing program directed at brush eradication, if successful, will adversely effect bobwhite populations. On the other hand, sparing a strip of mesquite or shinoak 50 to 100 feet in width, and at intervals of one fourth mile would accommodate the cover needs of bobwhite, provided that a food supply was adequate and accessible.

Wherever he lives or hunts, the would-be bobwhite manager should learn about cover requirements for bobwhite quail by studying ranges where coveys are located every year.



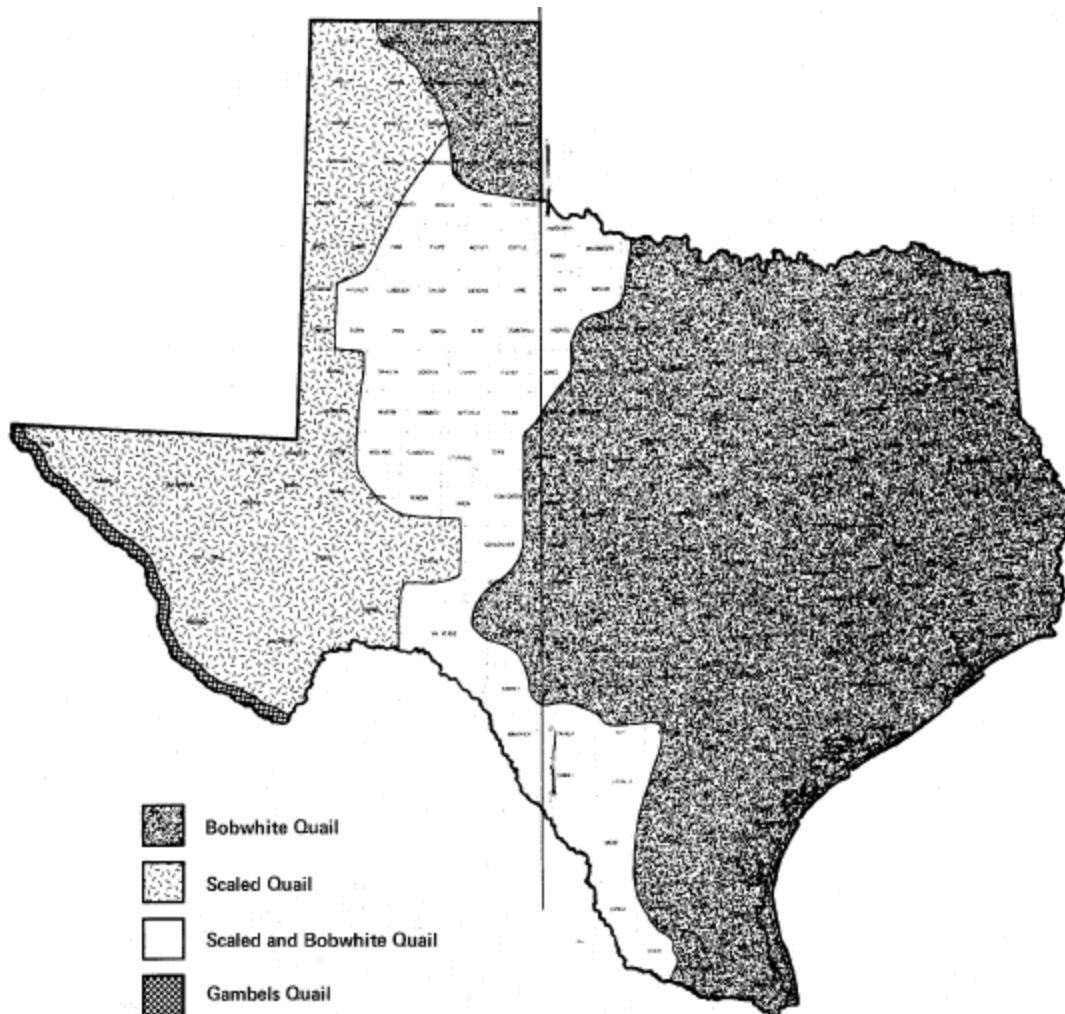

**AVOID THESE MISTAKES IF YOU WANT  
HABITAT MANAGEMENT TO BE  
SUCCESSFUL**

Bobwhite requires acreage out of all proportion to his small size. The maximum population attainable is believed to be one bobwhite per acre for any large block of range such as a farm or ranch.

Because the average covey consists of from 10 to 15 bobwhites, a block of 15 acres will seldom support more than one covey. This occurs only under ideal conditions, and seldom lasts more than a year. Thus, the acreage requirements of a bobwhite covey are equal to, or greater than, the acres required per cow over most of the native grazing ranges in Texas.



*Do not expect a plum thicket or grapevine to hold a covey of bobwhites if it is all the habitat in sight.*

It takes time to develop bobwhite habitat. Sources of natural food cannot be developed in less than one growing season. Cover, if improvement necessitates plantings, will be difficult to develop within less than four or five years. The improvement of existing cover takes less time and, if good cover is present, it may only need matching with a food supply. This again requires as much time as it takes to grow a food supply,

or one growing season. Quail management is not a spur-of-the-moment project to be undertaken today and abandoned tomorrow.



*Expect no success with bobwhites until their habitat is completed and "working".*

Success of food and cover plantings depends upon the amount of preparation of the seed bed and care given young plantings. Nursery stock of woody transplants are sure to fail if planted on raw soil and left to compete with natural growth of weeds and grasses. For all food plantings, a well tilled seed bed is essential. Rows of tree or shrub transplants need a side dressing with a disc harrow or cultivator several times each season during the first three or four years.



*It takes work to develop habitat from plantings.*

## BY-PRODUCT MANAGEMENT OF HABITAT

(Resulting From Good Land Management Practices Used Primarily for Other Purposes)

This is the most practical and economical type of quail habitat management because it serves two purposes at once.

### FOOD



1. Almost any soil disturbance results in growth of the weeds which produce quail food. This principle can be utilized anywhere by controlled burning, plowing, discing, fallowing or grazing. All these practices should be carried out after the end of winter but before spring growth gets underway.



2. Conservative grazing pressure results in sustained production of food-producing plants and, at the same time, insures preservation of needed ground cover.



3. Discing, contouring or pitting rangelands brings on weed successions productive of quail food.

### COVER



1. Protection of gullies to retard run-off helps develop good ground cover.
  - a. Where any pasturing of a field is done, gullies should be fenced out.



- b. Erosion often can be retarded or stopped with "thickety" plantings of woody cover in selected places.



2. Planting windbreaks or adding to existing windbreaks provides good escape cover.

- a. These should be fenced to preserve ground cover.
- b. Suitable shrub and tree species: Russian olive, black locust, eastern red cedar, desert willow, sumac and other drought resistant species are best for drier areas of Texas.
- c. Shrubbery species can be fitted into existing windbreaks and hedges which are too open.
- d. Tree and shrub plantings require tillage for at least three years. Thereafter, weeds and grasses improve this woody growth as bobwhite habitat.
- e. After woody plantings are established, weedy growth can be promoted by a single disking of the middles during March or April.



3. Planting oats or other temporary cover crops adjacent to woody cover adds to the value of cover and provides needed green food in winter.



4. Stubble left in the close vicinity of windbreaks or other woody cover adds to value of bobwhite habitat (this is especially effective in winter if there is combine waste or shocked grain left in the field).



5. Deferred or rotated grazing results in carry-over of dead grasses essential for nesting cover.



6. Use of spreader dams on livestock ranges retards run-off; it also results in good ground cover.

## HABITAT MANAGEMENT PRIMARILY FOR IMPROVING CARRYING CAPACITY OF LAND

### FOOD DEVELOPMENT

Any practice which sets back plant succession, including use of grazing animals within conservative limits, is beneficial to bobwhite quail if adequate cover is present.



1. It is wise to develop native food by plowing, discing or burning. March and early April are the best times.
  - a. Associate foods with existing woody cover, preferably in odd corners, brushy fence rows and hedges, alluvial spots along creek courses and edges of timbered plots.
  - b. If none of the weeds listed on pages 3 and 4 emerge, it will be necessary to plant or sow locally adapted species which will provide known quail foods. These might include sorghum, alnum millet, soy beans or annual lespedeza.



2. Leaving several rows of standing field grains adjacent to windbreak plantings or brushy fence rows is an effective practice under favorable conditions. This method has the disadvantage of such food supplies attracting blackbirds and rodents which quickly consume the grain. In providing such plantings for quail food, it is well to remember that it takes a strip approximately eight feet wide and a mile long to equal an acre. Be guided accordingly and leave enough for all feathered pensioners.

### COVER DEVELOPMENT

In situations where native cover is inadequate or has been destroyed, several improvements are possible.



1. Plant native or exotic shrubs proven in the locality and protect them from livestock.
  - a. For bobwhite utilization as escape or resting cover, use edge plantings along food supply or tie together scattered natural covers with hedge plantings.
  - b. Plan cover plantings to front the maximum feeding area.
  - c. Some desirable species, depending on location, are eastern red cedar, desert willow, Russian mulberry, Russian olive, squawbush, yaupon, rattan, grape, greenbrier, granjeno and prickly pear.



- d. Try for irregular or natural appearing patterns of coverts.



2. Where trees support grapevines but are too open at ground level to serve as quail cover, cut half through the tree a few feet above the ground and push it over, thus bringing living vines closer to earth.

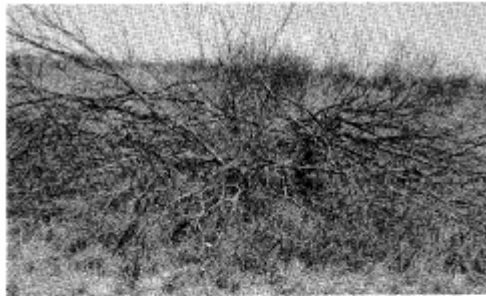

3. Mesquite brush ranges can be improved in respect to cover by half-cutting multiple trunks near ground level, allowing tips of limbs to touch the ground and serve as protection for ground cover. This method will be useless without the type of range management resulting in production of quail foods.

Before making any selection of food and cover plants, it might be profitable to ask the Texas Game and Fish Commission for advice and guidance about habitat problems.

Visit the outdoors each month through the full-color pages of

## TEXAS PARKS & WILDLIFE

...a magazine that takes you on an outing 12 times a year. We'll bring you stories on state parks, fishing in our many freshwater lakes and saltwater bays, Texas' abundant wildlife and anything else to do with the outdoors.

It's all illustrated with some of the nation's best color photography, and at a price that's hard to beat.

Complete the form below and mail it with your check or money order, or we'll bill you later.

M

Name \_\_\_\_\_

Address \_\_\_\_\_

City & State \_\_\_\_\_

ZIP \_\_\_\_\_

1 year \$10       2 years \$18       3 years \$26   
 Foreign                      Foreign                      Foreign  
 1 year \$12       2 years \$21       3 years \$30

Payment enclosed       Bill me later

Prices subject to change without notice.

For faster service call toll-free 1-800-937-9393



Texas Parks and Wildlife Department  
 4200 Smith School Road  
 Austin, Texas 78744

Dispersal of this publication conforms with Texas State Documents Depository Law, and it is available at Texas State Publications Clearinghouse and Texas Depository Libraries.

PWD-BK-7100-37-12/90

APPENDIX CC



Texas Parks & Wildlife Department  
4200 Smith School Road  
Austin, Texas 78744

Contribution of Federal Aid Project  
W-127-R



PWD-BK-7100-199-4/92

Dispersal of this publication conforms with Texas State Documents Depository Law, and it is available at Texas State Publications Clearinghouse and/or Texas Depository Libraries.

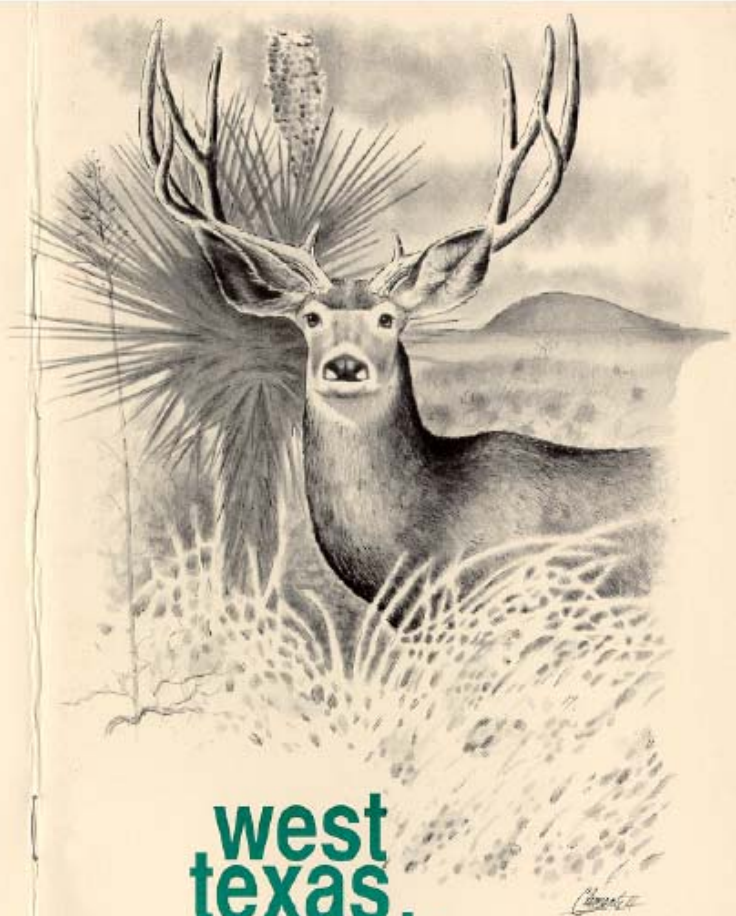

west  
texas  
mule  
deer

# west texas mule deer

by  
Timothy L. Bone  
and  
William B. Russ

## ***West Texas Mule Deer***

by  
Timothy L. Bone and William B. Russ

---

**W**hen the subject of deer is brought up, most Texans think of white-tailed deer. This is natural because white-tailed deer are by far the most common species of deer in Texas. Many citizens are not aware that another species of deer lives within the boundaries of their state.

**T**he mountains and canyons of west Texas provide habitat for the desert mule deer, one of the most important big game species that the state has to offer. Established populations of desert mule deer are found in the Trans-Pecos and Panhandle regions of Texas.

**M**any ranchers have discovered that demand for mule deer hunting is high. Among the game species in Texas, mule deer rank 10th in hunting popularity. Hunting lease revenue generated from this game species has become an important component of ranch income.

**A**esthetically, mule deer are a popular part of the natural environment in the western portion of the state. Visitors frequently stop in at Texas Parks and Wildlife Department field offices to ask biologists and game wardens where they can go to observe and photograph mule deer.

Research and management projects concerning the mule deer and its habitat requirements are conducted by wildlife biologists of the Texas Parks and Wildlife Department, federal agencies, and many universities in Texas. Research activities by wildlife biologists of the Texas Parks and Wildlife Department are 75 percent funded from federal excise taxes on firearms and ammunition. Research activities are also conducted on National Parks and private ranches.

The Texas Parks and Wildlife Department game warden field force is responsible to provide law enforcement services to protect the mule deer resource. Mule deer occur on four Department owned wildlife management areas.

Interest in mule deer is high. Biologists and game wardens in the western part of the state are often asked questions about desert mule deer. Following are some of most frequently asked questions about desert mule deer in Texas.



west texas  
mule deer ..... 2

### How many kinds of mule deer are there in Texas?

Although the range of the Rocky Mountain mule deer (*Odocoileus hemionus hemionus*) may extend into the northwest Panhandle, virtually all mule deer in Texas are of the smaller subspecies (*O. hemionus crooki*), the Desert Mule Deer.

### Where are mule deer located in Texas?

Desert mule deer occur in the Trans-Pecos, Edwards Plateau, High Plains, and Rolling Plains Ecological Regions (Figure 1). The Trans-Pecos population is largely continuous. The Edwards Plateau population is adjacent to the Trans-Pecos population and is confined to the Pecos River drainage. Mule deer in the Panhandle are found in isolated populations associated with the breaks and tributaries of the Brazos, Canadian, and Red Rivers and the caprock escarpment.

### How many mule deer are there in Texas?

The mule deer population estimate has fluctuated between 150,000-250,000 during the last ten years. Approximately 90 percent of the mule deer in Texas occur in the Trans-Pecos and western Edwards Plateau.

west texas  
mule deer ..... 3

**Figure 1** Distribution of Desert Mule Deer in Texas—1991

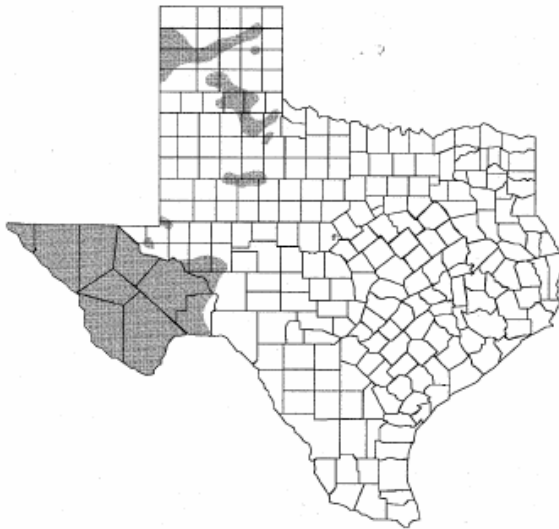

west texas  
mule deer ..... 4

### Do Texas mule deer migrate?

Unlike Rocky Mountain mule deer, desert mule deer are not considered to be migratory. Desert mule deer may shift their home ranges in response to the availability of water and forage or the presence of mountain lions. The home range for most Texas mule deer does not exceed 2 square miles.

### Do desert mule deer gather in large herds like Rocky Mountain mule deer?

Desert mule deer in the Trans-Pecos have been observed to form large groups in areas where the population densities are high. Herds of 20-40 deer may form during the January-March period.



west texas  
mule deer ..... 5

**What is the best method of counting mule deer?**

Daylight ground counts and aerial counts give the best data for fawn survival and adult sex ratios. Spotlight counts provide information on mule deer density.

**What do mule deer eat?**

Mule deer primarily eat browse (leaves, twigs, and young shoots of woody plants and vines) and forbs (weeds and other broad-leaved flowering plants). They eat some grass but only when it is green and succulent. Sheep, goats, and exotic big game compete directly with mule deer for preferred foods.

The following plants are examples of some Texas native desert mule deer foods that are readily taken when they are available.

**Browse:** lechuguilla, sotol, prickly pear pads and fruit, guayacan, oak leaves and acorns, mesquite beans and leaves, acacias, kidney-wood, juniper, condalias, mountain mahogany, silktassel, sumac species, and sand sagebrush.

**Grasses:** rescue grass, Texas wintergrass, fall witchgrass, panic grass, grama grasses, sedges and rushes.

**Forbs:** euphorbias, daleas, filaree, bladderpod, bluet, wild onion and wild mercury, mendora, lespedezas, vetches, carelessweed, partridge peas, and engleman daisy.

**When is the most stressful period on mule deer?**

The late winter period (mid-January through mid-March) is the most stressful for mule deer because of low forage availability. Adequate forage is usually available during spring and fall seasons.

**Do mule deer need to drink water every day?**

Desert mule deer can survive without drinking water every day. However, a lack of adequate drinking water effects reproduction and body condition. Constructing and adapting water facilities for wildlife use is an effective way to enhance wildlife populations and distribution in areas with limited surface water.

**Can the age of a mule deer be determined?**

Deer age is determined by tooth replacement and wear of the premolars and molars of the lower jaw. Unlike sheep, deer cannot be aged by their front teeth. Mule deer cannot be aged by antler characteristics.

**How can mule deer and white-tailed deer be distinguished?**

Mule deer have forked antler beams, larger ears, a black tipped tail, and a metatarsal gland approximately four inches long.

White-tailed deer usually have major antler points coming off a continuous main beam, smaller ears, a long broad tail that is white underneath, and a small circular metatarsal gland (Figure 2).

Mule deer usually run with the tail held down. White-tailed deer tend to run with the tail held up. Mule deer often escape in bounding leaps when they are frightened, compared to the white-tailed deer's more traditional running gait.

**Figure 2** Morphological differences between mule and white-tailed deer.

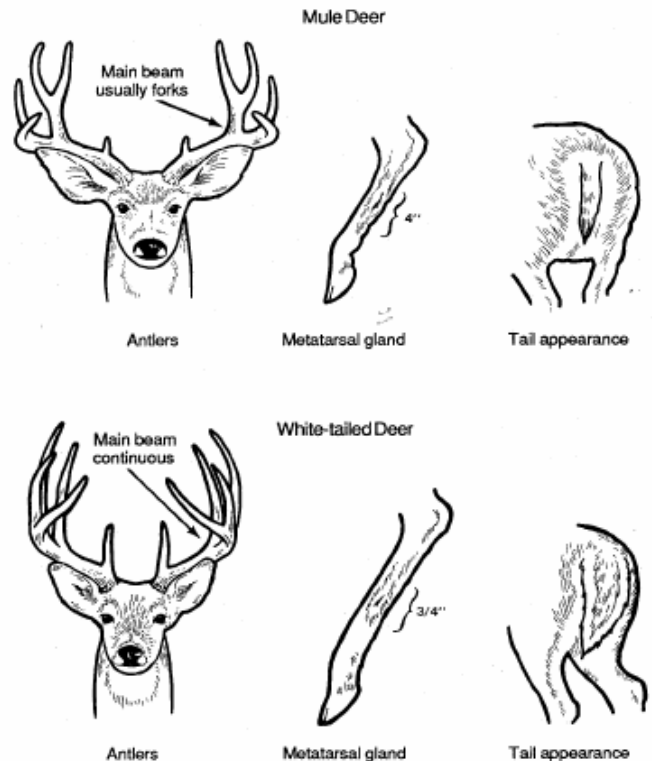

---

**Can mule deer and white-tailed deer interbreed?**

---

Yes, both types of parental matings have been documented (i.e., mule deer buck x white-tailed doe and mule deer doe x white-tailed buck). Hybrids can be recognized by the size of the metatarsal gland that is located on the outside of the rear leg between the hock and hoof. The metatarsal gland is typically about  $\frac{3}{4}$  inch long in white-tails and about 4 inches long in mule deer. Hybrids tend to have metatarsal glands about 2 inches long.

---

**Will white-tailed deer "drive out" the mule deer?**

---

White-tail deer do not physically "drive out" mule deer. White-tailed deer have expanded their range and population densities into some areas that were once the sole domain of mule deer. The expansion of white-tailed deer range appears to be correlated with an increase in brush density over the last 25 years. As brush density increases, the habitat becomes more suitable for white-tailed deer and less desirable for mule deer. When occupying the same area the two species tend to segregate themselves as mule deer prefer the rougher canyons and breaks while white-tailed deer are more common in the brushy draws.

west texas  
mule deer ..... 12

---

**What is a good buck to doe ratio?**

---

The proper buck-doe ratio depends on overall herd numbers. Fawn production and survival is often low in a desert environment. A 1:3 ratio is desirable where the population is stable and within range carrying capacity. In areas where natural mortality is high and deer densities are low, more does may be necessary to maintain the population.

---

**When is the breeding season?**

---

The mule deer breeding season in Texas extends from mid-November through mid-February with the peak occurring in late-December. The gestation period is about seven months. Therefore, most fawns are born in July and August.



west texas  
mule deer ..... 13

---

**Do doe mule deer always have twin fawns?**

---

No. Mule deer does generally breed the first time at the age of two and give birth to a single fawn. Older does may produce twins when forage conditions are adequate.

---

**Should spike bucks be harvested to increase the number of trophy bucks in the herd?**

---

Deer living in a desert environment are typically on a lower nutritional plane than those from a higher rainfall zone. Spike bucks are products of youth and/or poor nutrition and/or poor genetics. Preliminary results of ongoing research indicate that most bucks that were spike antlered as yearlings will produce desirable antler growth as age increases. Culling of yearling spike mule deer should be approached with caution.

west texas  
mule deer ..... 14

---

**When do mule deer bucks reach their greatest antler potential?**

---

Mule deer age and antler data collected during the hunting season indicates that antler characteristics continue to improve through 7.5 years of age. If increased antler size is a management goal, then the majority of harvested bucks should be at least 5.5 years old.

---

**Has the length of the hunting season resulted in over-harvest of mule deer bucks?**

---

No. The percentage of bucks in the Trans-Pecos mule deer herd that have been removed by hunters has remained below 11 percent for the last 10 years with both 9-day and 16-day season lengths.



west texas  
mule deer ..... 15

---

**Should supplemental feed be provided to mule deer?**

---

Providing additional feed may improve antler growth, reproduction, and overwinter survival. However, feeding programs are expensive and may be cost-prohibitive for most landowners. The best way to provide proper nutrition for deer is through good range and domestic livestock management practices. If a supplemental feeding program is contemplated, contact your local biologist.

---

**Does the Texas Parks and Wildlife Department restock mule deer?**

---

The deer trapping and restocking program was initiated in 1938 by the Game, Fish and Oyster Commission, predecessor of the Texas Parks and Wildlife Department and continues to the present. Restocking of mule deer is done only in approved areas judged as potentially good mule deer habitat that presently has no broodstock.

west texas  
mule deer ..... 16

---

**What can I do to increase mule deer numbers and quality?**

---

1. Learn the habitat requirements of mule deer and become familiar with the preferred mule deer foods.
2. Learn proper range and livestock management practices and their relationship to wildlife populations.
3. Obey state laws and rules established by landowners. Do not abuse the land on which you hunt or trespass where you do not have permission.
4. Landowners and hunters can provide a significant service to the game management programs of Texas by completely and accurately providing harvest data. Accurate harvest information is vital to the formulation of effective hunting regulations, whether it is solicited by mail questionnaire or in person by biologists in the field, at check stations or cold storage facilities. These regulations will allow the maximum harvest of surplus animals without endangering the broodstock necessary to replenish those populations.



west texas  
mule deer ..... 17

To obtain assistance with mule deer management, contact the nearest Texas Parks and Wildlife Department Technical Guidance Biologist. Technical Guidance Biologists serving West Texas are listed below:

Ruben Cantu  
1800 West Hwy. 90  
Alpine, Texas 79830  
(915) 837-5609

Gene Miller  
3409 South Georgia, Suite 25  
Amarillo, Texas 79109  
(806) 353-3141

Fielding Harwell  
309 Sidney Baker So.  
Kerrville, Texas 78028  
(512) 896-2500

Tommy Hailey  
Ivan Star Route, Box 67  
Breckenridge, Texas 76024  
(817) 362-4463

## Appendix DD

### Pesticides and Brush Control Texas Department of Agriculture

#### Pesticide Registration and Safety

The U.S. Environmental Protection Agency (EPA) and the Texas Department of Agriculture (TDA) register all pesticides used for brush control in the state of Texas. The Federal Insecticide, Fungicide and Rodenticide Act (FIFRA), the Food Quality Protection Act (FQPA), and Federal Food, Drug and Cosmetic Act (FFDCA) all regulate the use of pesticides in Texas to some degree. However, FIFRA and Texas pesticide laws and regulations are primarily involved in the registration process of brush control herbicides.



To be eligible for registration and use in Texas, pesticide products must first undergo a rigorous testing protocol required by EPA and then be registered federally. The testing protocol is extensive and must address issues such as efficacy and toxicity to non-target species. The vast majority of pesticide products that are registered in Texas are subject to over 140 scientific or toxicological tests in order to receive and maintain EPA product label approval, and subsequent Texas registration. Automatic approval does not occur for use of a pesticide in Texas if it is approved by EPA. Pesticides must meet state use and registration regulations in addition to strict EPA standards. The exact number of tests that must be performed for a pesticide to be allowed in Texas varies with its end-use, but it is extensive whatever the case. EPA evaluates a plethora of scientific studies before registering a product and uses a series of safety factors to determine the appropriate use patterns considering worst-case exposure scenarios.

Native Texas wildlife, especially threatened and endangered species, are given further consideration when performing risk assessments for the special use of pesticides in many brush control projects. Various classes of species are specifically targeted for detailed assessment, namely the chemical effects on amphibians and reptiles, birds, fish and invertebrates. The environmental fate of most compounds used in brush control is also carefully reviewed in order to protect water supplies. Factors such as degradative processes, absorption and mobility, field dissipation, as well as local ground and surface water concerns are considered in risk assessments, especially during special use considerations such as a FIFRA Section 24(c) allowances as discussed below.

Toxicity Category	Herbicide / Substance	Oral LD50	Equivalent Human Dose
I Severe Danger	Botulinus	0.00001	1 teaspoon or less
	TCDD (a dioxin)	0.1	
	Parathion	13	
	Strychnine	30	
	Nicotin	50	
II Moderate	Caffeine	200	1 teaspoon to 1 ounce
	2,4-D	375	
III Slight (caution)	Formaldehyde	800	1 ounce to 1 pint
	Aspirin, Vitamin	1700	
	Bleach	2000	
	Table	3750	
	Diuron	3750	
	Glyphosat	4320	
IV Very Slight	Imazapy	>5000	More than 1 pint
	Diesel	7380	
	Kerosen		
	Sugar		

Table 1: The equivalent human dose is that physical amount of the compound that would contain the oral lethal dose 50 (LD<sub>50</sub>) amount.



In reality and for all practical purposes of assessment, the amount of pesticide that a sensitive species must be exposed to and cause a harmful effect is very unlikely to be seen with any use of a pesticide product (Table 1). Even when these species may encounter these registered pesticides in a natural setting, most of these chemicals have relatively low toxicity or similar toxicity to that of many household or natural materials (Table 2).

Table 2: Overall toxicity rating based on the LD<sub>50</sub> and the dermal response rating are from 1 to 5, with 5 being the least severe

COMMON NAME	TRADE NAME	ORAL LD50 mg/Kg	TOXICITY RATING	DERMAL RESPONSE RATING
nicotine	for comparison	50-60	2	-
paraquat	Surefire	120	3	3
caffeine	for comparison	200	3	-
diquat	Diquat	230	3	4
2,4-D	various brands	600	4	4
tebuthiuron	Spike	644	4	4
MSMA	various brands	1,800	4	4
Aspirin	for comparison	1,240	4	-
hexazinone	Velpar	1,690	4	4
dicamba	Banvel	2,900	4	4
prometon	Pramitol	2,980	4	-
atrazine	various brands	3,080	4	5
pendimethalin	Pendulum	3,277	4	4
Table salt	for comparison	3,320	4	-
diuron	Direx, Karmex	3,400	4	4
bromacil / diuron	Krovar	4,260	4	5
glyphosate	Roundup	4,320	4	5
sulfometuron methyl	Oust	>5000	5	4
<b>imazapyr</b>	<b>Arsenal</b>	<b>&gt;5000</b>	<b>5</b>	<b>4</b>
imazapic	Plateau	>5000	5	5
prodiamine	Endurance	>5,000	5	4
simazine	Princep	5,000	5	4
bromacil	Hyvar	5,200	5	4
chlorsulfuron	Telar	5,545	5	5
picloram	Tordon	8,200	5	4
oryzalin	Surflan	10,000	5	4
norflurazon	Predict	>10,000	5	4
fosamine	Krenite	24,000		4

### FIFRA Section 24(c) Special Registration

A FIFRA Section 24(c) is designed to expand a currently registered product label in the state of Texas for a documented special local need (SLN). A SLN means an existing or imminent pest problem within Texas for which TDA, based upon satisfactory supporting information, has determined that an appropriate federally registered pesticide product is not sufficiently available.

Documentation of need for the 24(c) registration in the form of letters from producers, grower organizations, experiment station personnel, and/or extension service personnel, must be provided to EPA. Research and/or test data, or summaries supporting efficacy and safety must be submitted. In addition, data documenting expected residue levels (when appropriate, mainly when food or feed crops are involved) must also be supplied with the application packet to EPA. Prior to issuing a Section 24(c), EPA and TDA determine that use of the product for which registration is sought will not cause unreasonable adverse effects



on man or the environment when used in accordance with labeling directions or widespread and commonly recognized practices. Endangered and threatened species are especially considered when evaluating special uses of pesticides. The U.S. Fish and Wildlife Service, Texas Parks and Wildlife Department and TDA are in regular contact concerning the well being of all native Texas species.

The Texas Department of Agriculture obtained a FIFRA Section 24(c) Special Local Need registration to use *Arsenal*<sup>®</sup> (active ingredient imazapyr) to control saltcedar to conserve water and protect native habitats.

In fact, in several cases, saltcedar is being controlled with *Arsenal*<sup>®</sup> to enhance wildlife habitat. The Canadian Municipal Water District is planning to control salt cedar beginning in September 2004 along the Canadian River. This effort is being made to stop the spread of salt cedar, which is estimated to consume almost 70,000 acre feet of water each year in the river basin, and to enhance habitat for the Arkansas River Shiner. In addition, U.S. Fish & Wildlife Service and Panhandle Water Conservation District officials have proposed a joint project to finance the control of salt cedars along the Canadian River to enhance habitat for the Arkansas River shiner.

In another instance, the U.S. Fish & Wildlife Service and Fort Worth Zoo requested that TDA change the restriction on the use of *Arsenal*<sup>®</sup> in Salt Creek in Culberson County to enhance habitat for the endangered Pecos Gambusia. Additionally, the Colorado River Municipal Water District has worked with U.S. Fish & Wildlife and the Texas Parks and Wildlife Department to use *Arsenal*<sup>®</sup> along the Colorado River to preserve habitat for the endangered Concho water snake and the endangered Texas poppy-mallow. The Concho water snake is not affected by *Arsenal*<sup>®</sup> because this chemical generally only affects plant species. The Texas poppy-mallow is not affected by the saltcedar spraying because its habitat is not near saltcedar due to different soil preferences between the two plant species. Additionally, GIS mapping is done before helicopter spraying of *Arsenal*<sup>®</sup> to pinpoint Texas poppy-mallow habitat.

### Saltcedar (*Tamarisk*) Control in Texas

Saltcedar (*Tamarix spp.*) was introduced into the southwestern United States in the early 1800s from Eurasia as an ornamental shrub that aided in erosion control. A mature saltcedar may consume up to 200 gallons of water per day and is a problem for most of the western United States. Saltcedar trees occur in almost all of the water bodies of west Texas including the Pecos, Brazos, Canadian, Colorado, Rio Grande and Red rivers, and their tributaries.

Saltcedar has the ability to change its physical environment giving it a competitive advantage over native trees and shrubs. This occurs through increased surface soil salinity, lowered soil water potential and increased fire frequency. This invasive increases surface soil salinity by absorbing salts from deeper soil layers and groundwater and transporting these salts to their leaves, subsequently releasing the salts back into the surrounding soils through accumulation of leaf litter. The high tolerance for salt that saltcedar possesses allows for a competitive advantage. Increased soil salinity inhibits germination and growth of most other plant species.

The Texas Department of Agriculture is leading the Texas Riparian Invasive Plant (TXRIP) Taskforce in its endeavors to combat the spread of invasive riparian plants, especially saltcedar. This Taskforce is composed of almost every major state and federal agency with a mandate on this issue. TXRIP joins the US

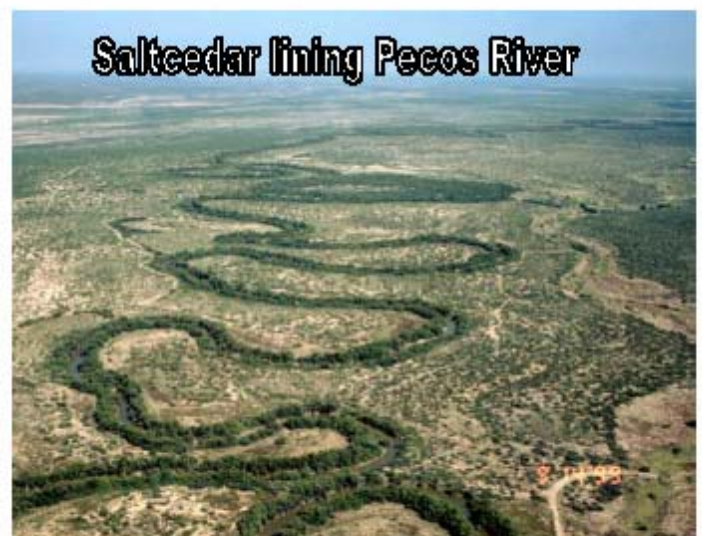

Tamarisk Coalition, the US Department of Interior, and the US Department of Agriculture in addressing this serious national problem. All scientifically tested methods for saltcedar control are assayed for use in control programs, including biological, chemical, and mechanical options.

Recent applications of federally approved herbicides, including *Arsenal*<sup>®</sup>, has proven to be a very effective and safe tool to control saltcedar in selected segments of Texas waterways. This has spurred an interest in using this means of control in other infested water systems.



APPENDIX EE

*The  
Lesser  
Prairie Chicken  
and its Management  
in Texas*

by  
George Litton  
Robert L. West  
David F. Dvorak  
and  
Gene T. Miller

**Table of Contents**

Forward ..... 2

Past and Present History and Distribution ..... 2

Factors Limiting Distribution ..... 4

    Habitat ..... 4

    Grazing Pressure ..... 6

    Chemical Brush Control ..... 6

    ‘Improved’ Pastures ..... 8

    Food Supply ..... 8

    Drought ..... 12

Habitat Management Considerations ..... 12

    Habitat Preservation ..... 12

    Proper Grazing Practices ..... 12

    Food Plots ..... 14

    Cultivation Practices ..... 14

    Brush Control/Management Practices ..... 14

    Prescribed Burning ..... 16

    Strip Discing ..... 18

    Flash Grazing ..... 20

Sources for Prairie Chicken Habitat Advice ..... 20

Literature Cited ..... 22

## Forward

The lesser prairie chicken (*Tympanuchus pallidicinctus*), unlike the coyote, bobwhite quail, or white-tailed deer has not been able to keep pace with man's civilization. Population levels have decreased markedly since early-day settlement. The prairie chicken has rather rigid habitat requirements and does not adjust readily to changing conditions. During the past 60-70 years, much of the native prairie chicken habitat has been destroyed by the plow, chemical control of vegetation, and severe overgrazing.

The basic information contained in this brochure was derived from Pittman-Robertson Projects W-45-R, Panhandle Game Management Survey, and W-126-R, Statewide Small Game Program.

## Past and Present History and Distribution

The range of the lesser prairie chicken in the United States is restricted to Texas, New Mexico, Colorado, Kansas, and Oklahoma. In Texas, the bird occurs primarily in the Panhandle and South Plains areas. A remnant population of the related Attwater's prairie chicken (*Tympanuchus cupido attwateri*), a State and federally listed endangered species, is found along the Gulf Coast of Texas.

The historic range of the lesser prairie chicken in Texas extended over most of the grasslands of the High and Rolling Plains. Today there remain two separate populations: one in the eastern and northeast Panhandle along the Texas-Oklahoma line, and the other in the South Plains along the Texas-New Mexico line from Andrews county to Bailey County. The populations are confined almost exclusively to sandy ridges containing shinnery oak and/or sand sagebrush, along with wild plum and skunkbush sumac in association with tall grasses such as sand bluestem, little bluestem, and switchgrass. Farming land is found adjacent to and interspersed within such ranges, including lands seeded back into permanent grass cover through the Conservation Reserve Program. Records indicate there may have been as many as two million lesser prairie chickens in Texas prior to 1900. Around 1930, installation of large farms, intensive grazing of grasslands, and a severe drought depressed their population to an all-time low. The Texas Legislature halted legal hunting in 1937. Surveys conducted in 1967 indicated the prairie chicken population was of sufficient size to allow a

• 2 •



*Today there remain two separate populations: one in the eastern and northeast Panhandle along the Texas-Oklahoma line, and the other in the South Plains along the Texas-New Mexico line from Andrews county to Bailey County.*

• 3 •

limited harvest. A two-day season was held in the northeast section of the Panhandle. The South Plains section was included in the hunt area beginning in 1970. Currently, two-day seasons are provided for in both areas.

The eastern section is comprised of approximately 800,000 acres scattered through Donley, Gray, Hemphill, Collingsworth, Lipscomb, and Wheeler Counties. The western counties of Bailey, Cochran, Andrews, Gaines, Yoakum, Terry, and Hockley have an estimated 350,000 acres of prairie chicken range.

## Factors Limiting Distribution

### *Habitat*

Habitat is the key to management of the lesser prairie chicken. Presently, prime habitat in Texas for this very specialized species is limited and the outlook for restoring historic habitat is questionable. Historically, large blocks of native rangeland were inhabited by the prairie chicken. The High Plains portion, with limited rainfall and relatively flat topography, supported a good growth of short grasses on hardland sites with clay loam soils. Interspersed sandy soils supported shinoak, sand sagebrush, and a mixture of warm season perennial bunch grasses. The Rolling Plains climax association contained bunch grasses on the sandy loam soils, with shinoak associations on the sands.

Much of the High Plains portion of this habitat has given way to the plow, and only sand-shinnery associations remain to maintain the prairie chicken on a year-round basis. Minimum acreage necessary to maintain prairie chicken populations is unknown, but there are many examples of sand shinnery oak tracts of 50 to 250 acres, interspersed within areas of cultivation, where prairie chickens no longer exist. For this reason, it may be concluded that large, solid blocks of native rangeland habitat in excess of 250 acres are a prerequisite to maintaining viable chicken populations. This conclusion is further supported by telemetry studies of prairie chickens conducted by Texas Tech University. Similar, but less extensive habitat alteration has occurred in the Rolling Plains.

A potential for prairie chicken range rehabilitation occurred with the introduction of the Conservation Reserve Program (CRP), a part of the Food Security Act, in 1985. This is a ten-year, voluntary United States Department of Agriculture program designed to conserve and improve soil

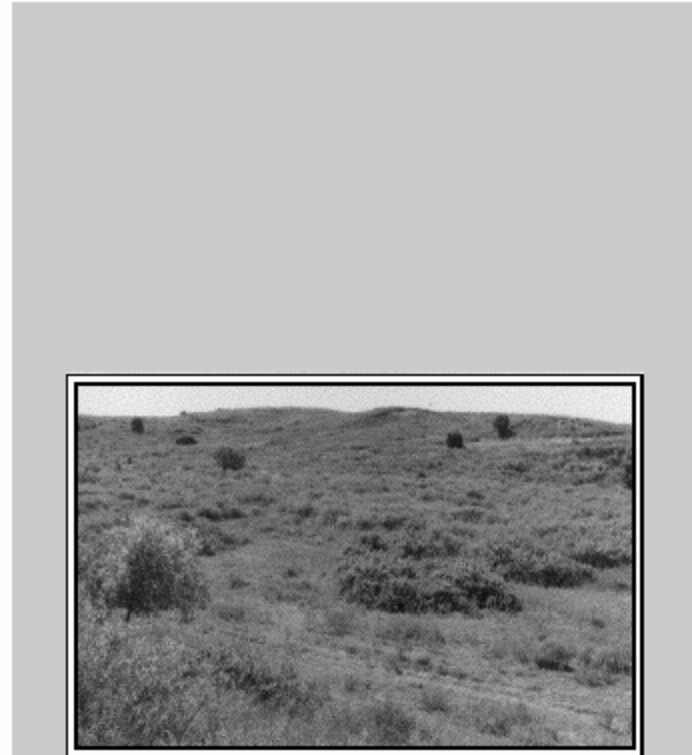

*Interspersed sandy soils support shinoak, sand sagebrush, and a mixture of warm season perennial bunch grasses. The Rolling Plains climax association contains bunch grasses on the sandy loam soils, with shinoak associations on the sands.*

and water resources by removing highly-erodible lands from crop production. Most of the prairie chicken range is located in areas qualifying for this program. Some of the more than 3 million acres of Texas farm land converted to CRP grasses may provide the prairie chicken with increased feeding, nesting, and brood habitat, with the potential for expanding or increasing populations; however, the **optimum** CRP mixture would consist of **warm season perennial bunch grasses, native legumes, forbs, and woody shrub plantings**, and many acres of CRP have been planted in less desirable, non-native plant species.

### *Grazing Pressure*

Extensive overgrazing has displaced desirable tall and mid-grass cover, sand shinnery oak, and forb food species on extensive acreages in the High and Rolling Plains. Sage/shinnery communities were undoubtedly the stronghold of the prairie chicken in the past; however, other areas offered seasonal feeding and nesting habitat for the birds.

Today, where overgrazing occurs on rangeland considered prairie chicken habitat, the birds have either disappeared or population levels are very low. Results of overgrazing on chicken habitat include the marked decrease of desirable food plants and destruction and modification of escape cover.

### *Chemical Brush Control*

Application of herbicides to control brush and weeds has adversely affected prairie chicken habitat. When extensive habitat areas are treated and food species destroyed, a decline in populations may be expected. Where **large scale** annual or bi-annual herbicide programs are maintained, native food plants may be partially or totally eliminated. As native rangeland becomes predominately a grassland, feeding areas are reduced or eliminated and only nesting cover remains.

If years of rest between application of herbicides (such as tebuthiuron) **or mosaic patterns** are not provided, a drastic reduction in shinoak motts may occur. These motts are not only important as producers of acorns, but also provide necessary brood-rearing areas, resting and loafing cover, and protection from extreme heat in summer or cold in winter.

Skinkbush sumac and sand sagebrush provide important food and cover to prairie chickens. These are extremely susceptible to herbicide treatments and can be almost totally eliminated from rangeland through continued herbicide applications. Sumac is often eliminated during the first application.



*The optimum CRP mixture would consist of warm season perennial bunch grasses, native legumes, forbs, and woody shrub plantings.*

### *“Improved” Pastures*

Throughout prairie chicken range, the common practice of plowing native grasslands and reseeded them with a monoculture of non-native grass such as lovegrass, presents yet another threat to prairie chicken habitat. Although these areas may be used as nesting cover, they offer little or no food and the grass stand is often too thick to be desirable for uses other than nesting or escape cover.

Lands to be reestablished in grass under the Conservation Reserve Program, or other similar programs in prairie chicken range, **should not** be planted to a monoculture of grasses. A selected mixture of native grasses, legumes and grain sorghum food plots is much more beneficial to all types of wildlife, especially prairie chickens. For example, an excellent mixture to seed on sandy loam sites (where most chicken range occurs) would be a combination of switchgrass, little bluestem, indiangrass, sideoats grama, plains bristlegrass, Illinois bundleflower, and Maximilian sunflower. **Note that grass species are warm-season bunch varieties, deep-rooted, drought-resistant, and very responsive to management with grazing and prescribed fire.**

### *Food Supply*

The food habits of the lesser prairie chicken are very specialized, certainly more so than most other game birds. Food species found in quail crops collected annually are almost too numerous to mention, while those foods found in chicken crops are relatively low in numbers.

Studies indicate a large portion of the bird's diet consists of shinoak acorns (Jackson and DeArment 1963, Cannon and Knopf 1981). Other plant species of primary importance in the fall are sixweek fescue leaves, broom snakeweed leaves, and flatsedge seed. Leaves and flower buds of skunkbush sumac, leaves of sand sagebrush, and cultivated grain sorghum (when available) are used during the winter.

Important plants in the spring are sixweek fescue, new annual forbs, and skunkbush sumac. In summer, insects (especially grasshoppers) dominate the diet; but again fruits of skunkbush sumac are taken along with leaves of dayflower, western ragweed, and evening primrose. Other forb species of importance are queen's delight, hairy puccoon, wild sweetpea, prairie ragwort, beard-tongue, and wild four o'clock.

Year-round availability of this narrow range of food items is essential to maintaining chicken populations. Many agricultural practices such as clean farming, burning of crop stubble, intensive livestock grazing, and application of herbicides tend to eliminate these food sources, resulting in the reduction **or elimination** of chicken populations.

•8•

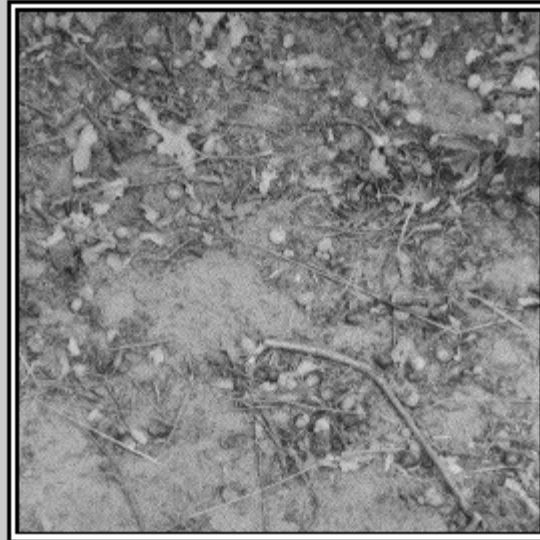

*Heavy shinoak acorn crops serve as valuable food for prairie chickens, deer, wild turkeys, and other wildlife.*

•9•



Native Food Items

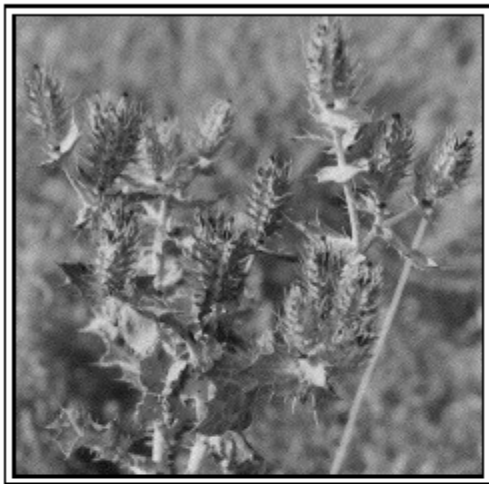

Bluestem pricklypoppy

Sandlilly



• 10 •

Snow-on-the-  
mountain



Western  
ragweed



• 11 •

## *Drought*

Drought cycles that occur periodically throughout prairie chicken range place extreme stress on populations. Census data indicate that population levels drop during these drought periods. Normally, some waste grain in cultivated fields may be available as winter food throughout occupied chicken range; however, this is not the case in extremely dry years when crops are poor and the limited forage is used by cattle, **or when interspersed farm lands in prairie chicken range have been seeded to grass monocultures with little or no diversity.** A shortage of nesting cover at these times on rangelands is often compounded when livestock numbers are not reduced and extreme overgrazing occurs.

## Habitat Management Considerations

### *Habitat Preservation*

No great amount of vacant prairie chicken habitat remains. Even where apparently suitable range is located adjacent to occupied range, prairie chickens have been slow to repopulate.

Restocking attempts with wild-trapped prairie chickens, in Texas and in other states, have at best met with limited success. At present, proper management and preservation of occupied native rangeland is the best hope for maintaining or perhaps increasing populations.

### *Proper Grazing Practices*

Light to moderate cattle grazing in deferred rotation programs have proven beneficial to cattlemen and prairie chickens. By providing pasture rest periods for vegetational response, prairie chicken food species (forbs or **weeds**) and nesting cover (mid-tall grasses) are enhanced. Areas considered marginal habitat because of livestock overgrazing can be restored or greatly enhanced as grazing pressures decrease.

Researchers (Canon and Knopf, 1981) noted a positive correlation between density of displaying males and percent grass cover in shinnery oak rangelands in western Oklahoma. Recent research in Cochran and Yoakum Counties (Haukos and Smith, 1988) showed that in herbicide-treated areas,

• 12 •



*By providing pasture rest periods for vegetational response, prairie chicken food species (forbs or weeds) and nesting cover (mid-tall grasses) are enhanced.*

• 13 •

nesting hens selected sites in residual grasses within **lightly grazed sand shinnery oak habitat** that had greater than 75% vertical screening cover in the first foot above ground level and 50% overhead cover present. For lesser prairie chickens, a grazing schedule and stocking rate should allow for **at least** these amounts of cover to remain on both **treated and untreated** sand shinnery oak rangelands to provide nest sites.

### *Food Plots*

Much of the prairie chicken range in Texas is surrounded or interspersed by areas of intensive cultivation. In these areas, grain sorghum fields provide large quantities of supplemental feed during fall and winter. Cultivated areas of alfalfa, wheat and oats provide important green plant material.

When native food sources have not been destroyed, this supplemental feed is not necessarily required; however, when available, birds often become very dependent on these foods. Small winter food plots of less than five acres may be beneficial to prairie chickens in certain situations.

### *Cultivation Practices*

Minimum tillage farming practices have provided additional supplemental food supplies for prairie chickens. After the grain is harvested, the stubble and waste grain remains in the field and is not plowed under until planting time the following spring. Birds have been observed feeding in such fields throughout the winter. Plowing or burning these stubble fields during the fall and winter should be discouraged.

### *Brush Control/Management Practices*

When applying herbicides in order to thin dense stands of shinoak or other brush species, care should be taken to leave untreated areas to support prairie chickens. Consideration must be given to brush acreage size, areas of mid-tall grasses, availability of native foods, and arrangement (or **interspersions**) of these habitat components. **Adjacent land use** must be included in evaluation and planning if careful patterns of brush control are incorporated in land management to benefit prairie chickens. **Landowners are encouraged to consult with Department biologists for technical assistance prior to conducting brush control work.**

Under certain conditions, extremely dense stands of low-growing shinoak may retard grass and forb growth. Production of desired plants often can be increased by opening this dense canopy. **Mechanical treatment** is advan-

• 14 •



*Much of the prairie chicken range in Texas is surrounded or interspersed by areas of intensive cultivation.*

• 15 •

tageous in that it stimulates forb growth; however, use of this technique should be carefully considered on an individual site basis, depending on topography and soil type.

Recent research in West Texas (Olawsky and Smith, 1991) shows that herbicide treatment of sand shinnery oak rangeland with tebuthiuron may enhance nesting cover by increasing mid-tall grass production and retarding brush growth, but most of the existing food supply for prairie chickens (acorns, forbs, and skunkbush fruit) is destroyed for at least 2 years. Adjacent untreated pastures or cultivated food sources then become necessary to furnish required foods, with forbs finally increasing in treated areas within 3-6 years.

Lesser prairie chickens may benefit from a **mosaic pattern** of both increased tall grass production from herbicide treatment and stands of untreated shinoak. Therefore several alternatives should be considered in a brush management program. They are:

- Never treat the same areas with herbicide in yearly repetition. A maintained program, treating periodically, will allow forb and brush regrowth to provide necessary food and cover for birds and also retard brush increase to a desired level.
- Contour or strip treatment of large areas is desirable. Untreated strips should be left wide enough to provide areas of desirable food production and cover next to treated areas.
- On large ranch units, a rotation method of brush management can be used. Portions of different pastures may be treated each year, maintaining an interval of 6-8 years for various untreated pastures.
- It is most desirable to leave mature, tall-growth forms of shinoak motts. Although this may require some extra care and skill on the part of the applicator, these motts are of utmost importance to prairie chickens and many other wildlife species. Also, destruction of motts on deep sand sites encourages severe wind erosion or "blowouts". Generally, such sites will not support any vegetation for sustained periods.

### *Prescribed Burning*

Prescribed burning is a management tool which may be used to enhance native grass nesting cover and forb (weed) foods. A certain degree of risk is involved, because this technique must be followed by rainfall to encourage



*Contour or strip treatment of large areas is desirable. Untreated strips should be left wide enough to provide areas of desirable food production and cover next to treated areas.*

plant growth. Care should be taken not to burn areas of deep sands, since severe wind erosion could occur.

Prescribed burning should be implemented in the spring around the time of last frost (late March - early April), just as grasses begin to green, with adequate soil moisture present. **Optimum forb production** for desired foods may be realized by earlier burning (February - March) using "back-firing" for cooler temperatures; however, this should only be used with ideal conditions and a high probability of moisture (rainfall) predicted to follow. **Landowners are recommended to have a prescribed fire plan prepared in advance, and always consult with the Texas Natural Resource Conservation Commission, formally the Texas Air Control Board, prior to conducting controlled burns.**

On ranches grazing cattle, usually small blocks are burned because of forage considerations and pasture rotations, but this can be planned for in advance. A 3-4 year burn rotation through all pastures in small blocks is optimum for enhancement of prairie chicken habitat and increasing palatability and % crude protein of livestock forage. Contact the Texas Parks and Wildlife Department, USDA Soil Conservation Service, or Texas Agricultural Extension Service for technical assistance in getting started with a prescribed burning program.

### *Strip Discing*

A practical method of stimulating growth of native foods for the lesser prairie chicken is the "**fallow discing**" of strips through native rangeland. The types of plants produced will vary with soil types, rainfall patterns, and past history of land use. As a rule, upland sandy loam soils, when disturbed, produce successions of western ragweed, trailing wild bean, pigweed (caressweed), partridge pea, groundcherry, lambsquarter, and crotons (doveweed). Clay loam upland soils will produce the same species, but in different percentages. All of these native seeds are eaten by prairie chickens when they are available.

Discing for native food management may be done at any time during the dormant season (first to last frost). However, late March is generally best because soil disturbance at this time of year destroys a minimum of existing food and cover. **If soil moisture is available**, vegetative growth will soon cover the disced area, reducing any danger of erosion.

Special cautions include discing on the contour (**on flat ground to no greater than 3% slope**) with narrow strips not to exceed 15', at a depth of 3" to 6" (just enough to create soil disturbance, **not a clean seed bed**



*Small winter food plots of less than five acres may be beneficial to prairie chickens in certain situations.*

**for planting).** This is best accomplished with an offset disc. Four to five strips across a section of land will furnish considerable amounts of native foods. Good judgement must be exercised when using this technique so as not to create a wind or water erosion problem.

### *Flash Grazing*

Production of native foods can also be achieved by employing the "flash grazing" technique. It basically mimics the soil disturbance effect of fallow disking, but is done with cattle hoof action. Often in the spring, a noticeable lush growth of native forbs occurs where livestock have been repeatedly fed during winter months. These feed grounds have been stimulated sufficiently by the cattle, and native forb species respond during the growing season.

A landowner may simply "hot wire" areas of 1-2 acres in size on upland clay loam sites (tight ground) during the February-March period and concentrate cattle heavily in these areas **for a short duration**, depending on the site, moisture conditions, and how long before noticeable soil disturbance occurs. Again this technique calls for careful management on a site-specific basis. Upland clay loam sites will generally require higher numbers of cattle for slightly longer periods as compared to sandy loam sites. Native foods produced in these areas will be as previously described.

## **Sources for Prairie Chicken Habitat Advice**

Department wildlife biologists are available to provide habitat and population management advice for prairie chickens and other species through the **Private Lands Enhancement Program**. This service is provided free of charge to interested landowners, and landowner compliance with verbal or written recommendations is strictly voluntary. Contact the Wildlife Branch Region I Office in San Angelo at 915/651-4748.



*It is most desirable to leave mature, tall-growth forms of shinoak motts. Although this may require some extra care and skill on the part of the applicator, these motts are of utmost importance to prairie chickens and many other wildlife species.*

## Literature Cited

- CANNON, R.W., and F.L. KNOPE. 1981. *Lesser Prairie Chicken Densities on Shinnery Oak and San Sagebrush Rangelands in Oklahoma*. Journal of Wildlife Management, 45(2):521-524.
- HAUKOS, D.A., L.M. SMITH, and G.S. BRODA. 1988. *Spring Trapping of Lesser Prairie Chickens*. Journal of Field Ornithology, 61(1):20-25.
- HAUKOS, D.A., and L.S. SMITH. 1988. *Lesser Prairie Chicken Nest Site Selection and Vegetation Characteristics in Tebuthiuron-treated and Untreated Sand Shinnery Oak in Texas*. Great Basin Naturalist, 49(4):624-626.
- JACKSON, A.S., and R.DeARMENT. 1963. *The Lesser Prairie Chicken in the Texas Panhandle*. Journal of Wildlife Management, 27(4):733-737.
- OLAWSKY, C.D., and L.S. SMITH. 1991. *Lesser Prairie Chicken Densities on Tebuthiuron-treated and Untreated Sand Shinnery Oak Rangelands*. Journal of Range Management, 44(4):364-368.



Federal Aid Report Series No. 33  
Contribution of  
Federal Aid Project W-129-M

This publication was funded by sportsmen's dollars derived from the sale of hunting licenses and by federal excise taxes on sporting arms and ammunition as authorized by the Pittman-Robertson Act, Federal Aid in Wildlife Restoration.

Fishiers & Wildlife Division • Wildlife Section  
1994



4200 Smith School Road  
Austin, Texas 78744

PWD BK 17103-025 (5/94)  
Copies of this publication conform with Texas State Documents Depository Law, and it is available at Texas State Publications Clearinghouse and/or Texas Depository Libraries.