

Texas Partners In Flight

Flyway

NEWSLETTER

Spring 1997– Spring 1998

Volume 5



Partners in Flight was formed to address the conservation needs of declining bird species. Federal and state government agencies, non-governmental conservation organizations, communities and conservation-minded corporations, landowners, and other businesses, have joined together in an international effort to address these declines. Together, we are working to understand the ecology and natural history of all birds in the Western Hemisphere, while also discovering the causes of their vulnerability. Our main goal is to implement actions needed to assure that these valuable species continue to occur in healthy and productive populations into the future.

The Goal of Texas Partners In Flight (TX PIF)

The Conservation Plan for Birds in Texas

The primary objective of Texas Partners In Flight (TX PIF) for 1997-1998 is to complete the State Conservation Plan for Texas, which is a national PIF effort. This Plan will lay the groundwork for voluntary bird conservation strategies in Texas with proactive initiatives and “partnering” opportunities to reverse the decline of bird populations in Texas. Once completed, there will be one combined *living* document comprised of nine physiographic regional plans for Texas.

The first planning meeting for Texas was a combined one for the West Gulf Coastal Plain (the Pineywoods) and the Coastal Prairies (central and upper Texas coast). The second meeting was for the South Texas Brushlands (south of the Nueces River), while the third meeting was held to discuss the Trans-Pecos region (far west Texas).

These “roundtable discussion meetings” with volunteer biologists, birders and conservationists proved invaluable for the development of long-term

conservation strategies for birds. Almost 100 people were invited to all three meetings combined, of which over 40 volunteered their time; those attending are listed below. A State Plan *Draft* is expected to be completed in late 1998 and peer-reviewed by numerous partners.

Attendees for the West Gulf Coastal Plain and Coastal Prairies Meeting held on April 8-9, 1997 in Lafayette, Louisiana were: Facilitator: Chuck Hunter-USFWS/SE PIF, Organizer: Virginia Rettig-USFWS(local contact and organizer), along with Wylie Barrow-USGS, Bill Fontenot-Lafayette Nat. Hist. Mus., Tom Harris-Boise Cascade, Rich Martin-LA TNC, Cliff Shackelford-TX PIF, Bill Vermillion-La. Dept. Wildl. Fish. and Doug Zollner-AR TNC.

Attendees for the South Texas Meeting held on May 14, 1997 at Santa Ana NWR were: Facilitator: Chuck Hunter-USFWS/SE PIF, Organizer: Cliff Shackelford-TX PIF, along with David Blankenship-USFWS (local contact and

organizer, Tim Brush-UT-Pan Am, Karen Chapman-Texas Audubon, Randy Fugate-TPWD, Scott Hedges-Texas Audubon, Joe Keepers-Kenedy Ranch, Tom Langshied-King Ranch, Jody Mays-Laguna Atascosa NWR, Chris Perez-USFWS, Cecilia Riley-Gulf Coast Bird Observatory, Nadine Varner-Laguna Atascosa NWR, Gary Waggerman-TPWD and Marc Woodin-USGS.

Standing on the summit of Mt. Livermore, the highest peak of the Davis Mountains at over 8,300 ft. in Jeff Davis Co. at the Texas Nature Conservancy meeting in August 1997. On a clear day standing on this summit, one can look to the south and see the Chisos Mts. and turn to the north and also see the Guadalupe Mts.



From left to right: Madge Lindsay, World Birding Center Project Leader, TPWD, Cliff Shackelford, State Coordinator, TX PIF and Chuck Hunter, Southeast Regional Coordinator, PIF. Photo by John Karger, TX INC.

Attendees for the Trans-Pecos Meeting held on August 20-21, 1997 at Sul Ross State University in Alpine, TX were: Facilitator: Chuck Hunter-USFWS/SE PIF, Organizer: Cliff Shackelford-TX PIF, along with Bill Bourbon-Big Bend NP, Kelly Bryan-TPWD, David Hedges, Linda Hedges-TPWD (local contact and organizer), Jim Hines, John Karges-TX TNC, Bonnie McKinney-TPWD, Clay and Jody Miller, Carolyn Ohl-Kolb, Sister Barbara Jean Potthast, Calvin Richardson-TPWD, John Schmidt, Chuck Sexton-USFWS, Roland Wauer-Big Bend NP (retired), Carl White, Greer Willis and Janice Wobbenhorst-Guadalupe Mts. NP.

This article was used with permission from a US Fish & Wildlife Service pamphlet, "Migratory Songbird Conservation" and was edited by Terry Ross.

Americans keep an estimated 60 million cats as pets. Let's say each cat kills only one bird a year. That would mean that cats kill over 60 million birds (minimum) each year—more wildlife than any oil spill. Scientific studies actually show that each year, cats kill hundreds of millions of migratory songbirds. In 1990, researchers estimated that "outdoor" house cats and feral cats were responsible for killing nearly 78 million small mammals and birds annually in the United Kingdom. University of Wisconsin ornithologist, Dr. Stanley Temple estimates that 20-150 million songbirds are killed each year by rural cats in Wisconsin alone. Feline predation is not "natural." Cats were domesticated by the ancient Egyptians and taken throughout the world by the Romans. Cats were brought to North America in the 1800's to control rats. The "tabby" that sits curled up on your couch is not a natural predator and has never been in the natural food chain in the Western Hemisphere. Cats are a serious threat to fledglings, birds roosting at night and birds on a nest. Research shows that declawing cats and bell collars do not prevent them from killing birds and other small animals. For healthy cats and wild birds, cats should not be allowed to roam free. Work with your local humane society, veterinarians and state wildlife agency to enact and enforce free-roaming cat regulations.

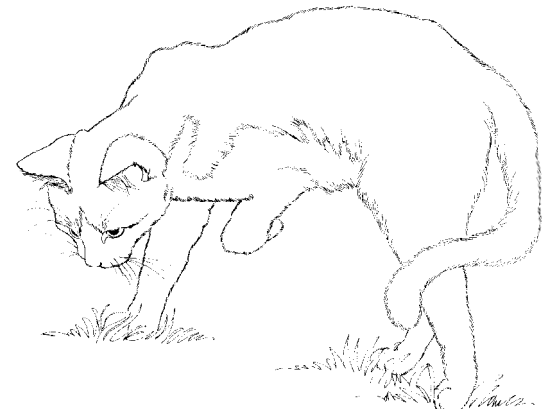

For more information:

Free Roaming Cats

By The American Backyard Bird Society,
PO Box 10046, Rockville, MD 20849.

Cats: A Heavy Toll on Songbirds

By Rich Stallcup
Point Reyes Bird Observatory
4990 Shoreline Hwy., Stinson Beach, CA 94924.

Is there a Killer in Your House?

By George Harrison
National Wildlife Magazine (October/November 1992).

Beware of Well-Fed Felines

By Peter Churcher and John Lawton
Natural History Magazine (July 1989).

**Check out the TX PIF web page
for lots of great information:
<http://www.tpwd.state.tx.us/adv/birding/pif/txpif.htm>**

Urban Conservation

What You Can Do For Birds in Urban Settings: *Texas Wildscapes* Turns Backyards Into Wildlife Havens

from a recent press release by Kelly Bender



At a time when concrete and cropland are replacing wildlife habitat across Texas, state biologists are trying to work with the forces of civilization by encouraging urbanites to turn businesses and backyards into wildlife havens.

Texas Wildscapes emphasizes providing the basics for good habitat: food, water, and cover. Statewide program participants receive “how-to” information packets, and can then certify their property as backyard wildlife habitats. The program currently boasts over 6000 participants and over 920 certified sites throughout Texas.

“Along with providing the basics for wildlife, we are asking that participants use at least fifty percent native plants in their Wildscape,” said Kelly Bender, Texas Wildscapes Coordinator. “Native plants are beautiful and most have lower water demands, fewer pest problems, and require less fertilizer than many exotic or hybrid species. This adds up to easier maintenance and less expense.”

According to recent census data, 82 percent of all Texans now live in nine metropolitan areas. “We’re going where the people are,” said Bender. “The immediate benefit of Wildscapes is enhanced wildlife habitat in cities. The long-term and potentially greater benefit is a better-educated population that is more supportive of wildlife issues.”

“When you see a hummingbird drink from a feeder you hung, or a colorful songbird feed in a fruit tree you planted, these are exciting wildlife experiences. People experience a direct connection between personal action and the benefits of conservation.”

While ideal for the urban backyard, the program is also well suited to the small property owner. Property owners with just a few acres or even those with several hundred acres may have felt they needed more land to pursue wildlife management, but Bender says any property can benefit from the Wildscapes approach. Individual Wildscapes can be as simple as providing feeders, birdbaths, and nest boxes for birds, or as complex as creating elaborate landscaping projects of restored native plants. The goal is to provide places for wild creatures to feed, drink, and hide from predators and raise young.

A key element of the program is a certification process whereby property owners can register their Wildscape with TPWD’s Nongame and Urban Program office. For a \$15.00 fee, TPWD will send a sizable packet of information on general backyard wildlife, bird feeders, nest boxes, plantings to attract birds, and landscaping with native plants. A regional native plant list, booklets on hummingbird and butterfly gardening, and a book called The Backyard Naturalist by Craig Tufts of the National Wildlife Federation, a nonprofit conservation group, are also included in the packet.

Finally, an application for certification can be returned to the department to qualify for a personalized certificate and outdoor display sign. The funds raised from the Wildscapes program not only fully pay for the program, but also support nongame education, management, and research throughout Texas.

Along with the certification process, TPWD is developing Wildscape demonstration sites in major metropolitan areas that will allow the public to observe firsthand what it takes to create wildlife habitat. Eighteen demonstration sites have been set up in the Dallas/Ft. Worth area and in Houston. Those interested in visiting a demonstration site should call the TPWD urban program office at 972-293-3841 (Dallas) or 713-456-9350 (Houston).

To receive a Texas Wildscapes information packet, send a \$15 check or money order made out to: Texas Wildscapes, 4200 Smith School Road, Austin, Texas 78744 or call Kelly Bender, Wildscapes Coordinator, at 512-389-4974.

Research

Natural Resources Program: Avian Monitoring and Management on State Parks

by Mark Lockwood and David Riskind
Natural Resource Program, Texas Parks and Wildlife

Texas is well known for its diversity of habitats and its rich and interesting birdlife (currently with 606 documented species in the state). From the mountains and deserts in the far west to the southern mixed pine-hardwood forests in the east, Texas avifauna is matched by no other U.S. state. One area of Texas that contributes greatly to this diverse avifauna is the subtropical zone on the Rio Grande Delta. The delta, also known as the Lower Rio Grande Valley, is one of only two subtropical zones on the mainland United States. In addition, Texas is internationally recognized for the spectacular assemblages of neotropical migrants, particularly along the upper Texas coast. Within the Texas State Parks system there are sites representing most of the major habitat types of the state. Thus, Texas State Parks provide opportunities to explore this vast avifauna.

The Natural Resource Program is one of many programs at Texas Parks and Wildlife that has a long history of involvement in the conservation and management of Texas' avifauna. The Natural Resource Program is charged with resources management and habitat stewardship on state parks. Careful management and restoration of natural ecosystem fragments provide improved habitat for Texas' avifauna. Trail access, as well as photo blinds and observation platforms, in the major habitats found in natural areas of resource-oriented parks provides rewarding birding throughout the state.

As a product of baseline assessment of natural resources in state parks and other TPWD lands, bird checklists are developed. These booklet make natural resource information available to the public. A substantial effort is made to produce quality checklists; this effort is possible only through volunteer assistance. Many of the best field observers in Texas have contributed to the development of these checklists. To date, there are checklists published for approximately 50 state parks. The volunteer check-list compiler is key to the success of the final product. The Natural Resource Program acts as a managing editor and publisher.

The first state park checklists were published in 1975 with the first editions of the Meridian, Palmetto and Palo Duro Canyon State Parks lists. These lists were compiled by some of Texas' birding icons, such as Warren Pulich, Rose Ann Rowlett, Ken Seyffert, Fred Webster and Ed Kutac, to name just a few.

In 1980 the Natural Resource Program of Texas Parks and Wildlife published a small booklet titled *Birding in Texas*. This was one of the TPWD's first efforts to promote nature tourism. The second edition was published in 1992 and over 100,000 copies have been distributed through the Texas Department of Transportation's Travel Information Centers, state parks and direct mail requests. This publication has continued to expand with the recently published third edition, made possible through the partnership between TPWD and several contributors, including Victor Emanuel Nature Tours, Timber Ridge Tours, Greater Corpus Christi Business Alliance, Rockport Chamber of Commerce, The Texas Department of Commerce, and the Texas Department of Transportation.

In 1984 the first edition of *A Checklist of Texas Birds* was published. It was the first Texas Parks and Wildlife publication to provide an accurate listing of all of the birds recorded in Texas. The checklist followed the taxonomy set forth by the American Ornithologists' Union. The checklist was designed to facilitate gathering data on the state's birdlife through the recording of observations by location or in diary fashion. It has been revised periodically to keep pace with the increased knowledge of Texas' avifauna. Since the first edition, great strides have been made in documenting Texas' avifauna. Over the past ten years the booklet has been updated three times in order to provide up-to-date information as has our understanding of Texas birds. The current edition contains 624 species, plus a small list of hypothetical species. The checklist is kept current on Texas Parks and Wildlife's Web site: www.tpwd.state.tx.us/nature/wild/birds/txchecklist/intro.htm The list, including hypotheticals, now stands at 632.

An important part of the Natural Resource Program is long-term baseline inventory and monitoring initiatives. Avian point counts have been established at a few state parks. The counts provide quantitative data about species composition in particular habitats. The Natural Resource Program is in the process of developing a plan, in conjunction with Texas Partners in Flight, to establish point counts at state parks in all areas of the Texas. This plan, as with the bird checklists, will rely on strong volunteer support. These point counts will allow birders to collect quantitative data about birds in their region. For each park chosen for the program, a number of points will be established to encompass all of the different

Research (continued)

habitat with the park. The real value here is that the surveys can be repeated over time to monitor changes in the avifauna. Land use changes in the park or surrounding area are factors that could lead to measurable changes in the birdlife. There have been very few long-term studies such as this in Texas. We can now only loosely “compare” information on Texas’ diverse and changing avifauna over time.

There are also several long-term banding studies underway. A banding station at Davis Mountains State Park has been in operation for six years and another operation at Kickapoo Cavern State Park was in operation for eight years. These stations provide valuable data on the survivorship and site fidelity of passerines, and a glimpse at the avifaunal species richness not readily observed, particularly with respect to Neotropical migrants. Other short duration banding operations have been undertaken at a number of other parks. The banding data from these short-term operations, as with the longer-term stations, are useful in developing an inventory of the species utilizing a particular park.

The collection of quantitative data is very important. Long-term studies with standardized, repeatable methods are the key to the detection of trends in avian populations. Data collected from such studies can be compared and can be used to assess habitat quality as it relates to use by specific species. Much of what we know about populations of birds in Texas comes from anecdotal reports. This information is important, but it is time that more structured studies are undertaken so that we can better understand the dynamics of our avifauna.



Black-throated Green Warbler
Photo By Mark Lockwood

Anyone wishing to participate in working on a checklist should contact Mark Lockwood at:

Natural Resource Program
4200 Smith School Road
Austin, Texas 78744
512-389-4898 or by e-mail at
mark.lockwood@tpwd.state.tx.us

Tidbits



TX PIF continues to be a main partner (along with Texas Parks and Wildlife and Texas Audubon Society) of the second annual GREAT TEXAS BIRDING CLASSIC to be held April 25-May 2, 1998. TX PIF has assisted with the “bird technical” aspects (checklists and judging) of this birding competition in its first year, but now supervises the event as of February 1, 1998. Last year, over \$50,000 was raised for three Texas bird conservation projects.



THE GREAT TEXAS COASTAL BIRDING TRAIL maps of the central portion of the trail are still available for a nominal fee. To order a map, please call Nica Eckols at 512-389-4937. Maps and signs for the upper portion are due out sometime in 1998 and the lower portion in 1999.

Talk is brewing of inland birding trails for the entire state. The trails are a great way to get communities involved in being aware of saving precious bird habitat. Saving habitat can result in the addition of a site to the trail. Site listings attract travelers interested in observing birds in their natural habitat. Communities adjacent to trail sites benefit economically from tourist dollars spent on food, gas and lodging. Ecotourism is the fastest growing segment in the tourism industry.

Community Bird Sanctuary Program

The TX PIF-sanctioned Community Bird Sanctuary Program, which is only in *draft form*, has not taken full flight at the present. The interest is there from communities desiring this prestigious designation, but the lack of funding and person-power keeps the program from peaking. Fred Collins of The Nature Discovery Center in Bellaire has graciously agreed to help launch the program by making sure that it has practical application on the ground while still providing native, wild habitat for birds in urban settings. This program is very similar to the Flight S.T.A.R. program (read more about it in this issue), but designates towns, cities and other “sizable” communities to be recognized for consciously providing habitat for birds in urban situations.

If you know of a foundation that could help, a corporation that would like to make a donation to assist with the development of this project, or if you would like to volunteer your services, please contact the TX PIF office.

Citizen Monitoring

Swallow-tailed Kite Monitoring Project

TEXAS PARKS AND WILDLIFE



**HAVE YOU SEEN
THIS
BIRD?**

Swallow-tailed Kite

We want your sightings, *plus* there's a **REWARD:** for finding a confirmed, active nest in Texas.

Both the range and numbers in the U.S. of the Swallow-tailed Kite have been greatly reduced. A partnership between Texas Partners in Flight, Texas Parks and Wildlife, Temple-Inland Forest and U.S. Forest Service has identified this species as needing conservation attention. You can help in determining the extent and concentrations of these kites in Texas by filling out the attached form and sending it to Texas Partners in Flight.

SURVEY FORM

Texas Partners In Flight (TX PIF) along with Temple-Inland Forest, Texas Parks and Wildlife and the U.S. Forest Service have initiated a SWALLOW-TAILED KITE (hereafter "kites") monitoring project throughout Texas. Survey forms have been distributed in February 1998. Included in this pamphlet is a postage-paid return data form for submitting sight reports throughout Texas.

This species is one of the highest priority species for Partners In Flight (PIF), an international effort to reverse the declines in migratory landbirds. This Texas monitoring project was adapted from a Georgia PIF kite project.

In Texas, documented nests are extremely rare since this is the western edge of their U.S. breeding range. There are only three confirmed nests since the period of 1911-1914: one in Tyler Co. in 1994 (by Ray Brown and Howard Williamson) and the other two in Chambers Co. in 1996 and 1997 (probably the same pair returning in consecutive years; by Grady and Lu Skillern).

To make the Texas monitoring project more interesting and to show how important this bird is as a nester in Texas, Temple-Inland Forest is offering a \$500.00 cash reward for the discovery of an active nest. In order for the discoverer to claim the reward, the nest must be at a previously unknown nesting site and at least one of the principal investigators must be taken to the active nest. If the nest is found on private land, a signed letter from the landowner granting permission to access the property and to report the nest will be required to claim the reward. Photos, notes, anecdotal "talk," etc. does not constitute an active nest. The nest must be unharrassed, "in use" and physically seen by at least one of the principal investigators.

The principal investigators are Cliff Shackelford (TX PIF - Austin, TX), Joe Hamrick (Temple-Inland Forest - Diboll, TX), Ray Brown (USFS - Nacogdoches, TX) and Ross and Dawn Carrie (Raven Environmental, Huntsville, TX and USFS - New Waverly, TX, respectively).

Data forms are available to anyone who requests them. Major contributors are expected not only to be active birders, but timber cruisers, loggers, landowners, fishermen, game wardens and many other non-traditional birdwatchers who spend a lot of time in the field and can readily identify this spectacular bird.

All sight reports are very important to this project and the data form is simple to complete and return. After a season or two of collecting these sight reports, we should see where areas of concentration are and hopefully new ones will become known due to these efforts.

Technical Guidance For Landowners

Non-game bird **Landowner Assistance** has been initiated by TX PIF. A short video news release highlighting the Masser Family Ranch (La Cazadores, Inc.) in Gillespie County, produced by TPWD's Media Services, aired in late summer to over one million viewers mostly in Texas.

Building a bird checklist for a ranch is the first step. The next step is marketing to the nature tourism industry, which offers interested landowners the opportunity of providing birding tours on their property as a source of seasonal income. Big game ranches with extensive acreage and cabins for overnight guests can profit from this growing business. Texas now has over three major ranches who have opened their gates to the business of birdwatching. The first three ranches leading the way are the King, Kenedy and Fennessey ranches. Texas also has four of the top ten birding destinations in the nation which bring the birders to Texas.

For more information, call TX PIF at 512-389-4970.

Training Workshops On Wildlife Management Areas For Wildlife Biologists

by Noreen Damude, Nongame Biologist, TPWD

Noreen Damude, Texas Parks and Wildlife (TPWD) Nongame Wildlife Program, and Craig Farquhar, TPWD Endangered Resources, presented Bird Censusing and Point Count Training Workshops to staff biologists on eight Wildlife Management Areas (WMA's) representing the various TPWD wildlife regions and districts of Texas. Each workshop ran for one week and included visiting the various habitats for sessions on: bird identification by sight and sound, point count methods, line-transect methods, statistical design, point count and transect forms, field practice and literature handouts. From 5 to 17 Texas Parks and Wildlife staff who had expressed interest in doing bird surveys attended each workshop. The schedule was tight and many miles of Texas roads and highways were logged in.

The following Wildlife Management Areas were visited:

Region 4: The J.D. Murphree WMA - April 29 to May 3- Upper Texas Coast;
The Chaparral WMA - May 6 to May 10 - South Texas

Region 2: The Walter Buck WMA - May 20 to May 24 - Texas Hill Country;
The Kerr WMA - May 27 to May 31 - Central Texas

Region 1: Elephant Mountain WMA - June 3 to June 7 - Trans-Pecos;
The Matador WMA - June 10 to June 14 - Panhandle

Region 3: Richland Creek WMA - June 17 - 21 - Post Oak Savannah;
Alazan Bayou WMA - June 24 - 28 - East Texas Pineywoods

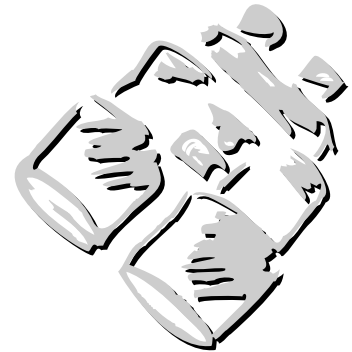

Cliff Shackelford (formerly of the U.S. Forest Service) and Howard Williamson of the U.S. Forest Service lent technical assistance and expertise to the East Texas Pineywoods workshop and made facilities and U.S. Forest Service lands (Experimental Forest) available for field practice.

Damude and Farquhar returned during the 1997 breeding season to help with the censuses on the Gus Engeling, the Kerr and the Chaparral WMAs. In connection with the Base-line Inventory Monitoring Workshop organized by Matt Wagner, Nongame Wildlife Program Leader, these training sessions aimed to provide hands-on experience identifying and recording birds in the field to those staff who expressed a desire to further hone their nongame and neotropical migratory bird identification skills.

Partner Donations Help

The **Compaq Computer Corporation** has graciously donated \$15,000 in computer equipment to Texas Partners In Flight; Compaq has also been a major supporter of the Great Texas Birding Classic. A total of nine computers were made available for bird conservation work. Five laptops and four desktops are used on the Great Texas Birding Classic for one month of the year and the remainder of the year they are used by the TX PIF office or they are on loan to avian researchers in Texas.

For Spring 1997 through Spring 1998, one laptop was being used by Ray Brown, a graduate student at Stephen F. Austin State University, working on Prothonotary Warbler nesting in the West Gulf Coastal Plain (eastern Texas). Another was used by Curt Zonick of Texas Audubon Society as he researches plovers and other coastal bird species. The third laptop is being used by Cecilia Riley of the Gulf Coast Observatory (and past TX PIF State Coordinator) for compiling a Southeastern PIF Regional Migration Monitoring Program. Active birders and researchers from the entire Southeast have sent in data from bird surveys they have conducted during fall migration 1997. To volunteer your time for the field work of this monitoring program, call Cecilia Riley at 713-789-4226.

The Coastal Bend Audubon Society was permanently assigned a desktop at Blucher Park for their work with bird conservation and education on the central Texas coast. The other desktops went to the TX PIF office, which was in desperate need of new computer equipment.

Jim Stiles, owner of the **Microtel Hotel** in McAllen, graciously donated rooms for ten nights to TX PIF for work travel in the Rio Grande Valley. **Microtel's** contribution greatly helps with the high cost of travel expenses. Be sure and stay in the Microtel next time you're in the Valley; please support those who support bird conservation!

The Flight S.T.A.R. Program

With The Flight S.T.A.R. Program, Partners In Flight recognizes any educational facility (zoos, nature centers, parks, corporate lands, gardens and others) promoting public awareness of bird conservation. The Flight S.T.A.R. program, an acronym for "Securing Tomorrow's Avian Resources," was formerly the Flight School Program, but has recently acquired a new and more appropriate name.

Recognition is divided into five categories of commitment to the conservation of birds: conservation, surveying and monitoring, outreach, education, and research. The program has just begun in Texas with The Nature Discovery Center in Bellaire, Texas serving as the model. The executive director of that facility, Fred Collins, has been extremely helpful in getting this project rolling. An outdoor sign and recognition certificate are currently being designed to be proudly displayed at the site. If you know of a facility in your area that should apply for recognition, please contact TX PIF for more information.



STATE COORDINATOR

Cliff Shackelford
Texas Parks and Wildlife
4200 Smith School Rd.
Austin, TX 78744

phone 512-389-4970
fax 512-389-4388
clifford.shackelford@tpwd.state.tx.us

REGIONAL COORDINATORS

D1 West Gulf Coastal Plain

Dawn Carrie
USDA-USFS
394 FM 1375 West
New Waverly, Texas 77358

E1 Texas Coastal Prairies

Cecilia Riley
Gulf Coast Bird Observatory
9800 Richmond Ave., Suite 150

Ted Eubanks
Fermata Inc.
3011 N. Lamar Suite 306
Austin, Texas 78705

E2 Oaks and Prairies (Glaciated Coastal Plain)

David Sierra
Texas Parks and Wildlife
P.O. Box 2127
Sulphur Springs, Texas 75482

E3 Osage Plains

Dr. Robert Neill
Dept. of Biology, UT-Arlington
Box 19498
Arlington, Texas 76019

E4 Red Rolling Plains

Ken Seyffert
2206 S. Lipscomb
Amarillo, Texas 79109

E5 Staked and Pecos Plains

Ken Seyffert
2206 S. Lipscomb
Amarillo, Texas 79109

E6 Edwards Plateau

Chuck Sexton
USFWS
Balcones Canyonlands NWR
10711 Burnet Rd., Suite 201
Austin, Texas 78758

E7 South Texas Brushlands

Gary Waggener or Steve Benn
Texas Parks and Wildlife
410 North 13 Street
Edinburg, Texas 78539

Dr. Tim Brush
Dept. of Biology, UT Pan-American
1201 W. University Dr.
Edinburg, Texas 78539

E8 Chihuahuan Desert and Mexican Mountains in Texas

Linda Hedges or Kelly Bryan
Texas Parks and Wildlife
P.O. Box 948
Ft. Davis, Texas 79734

TEXAS PARTNERS IN FLIGHT PHYSIOGRAPHIC REGIONS

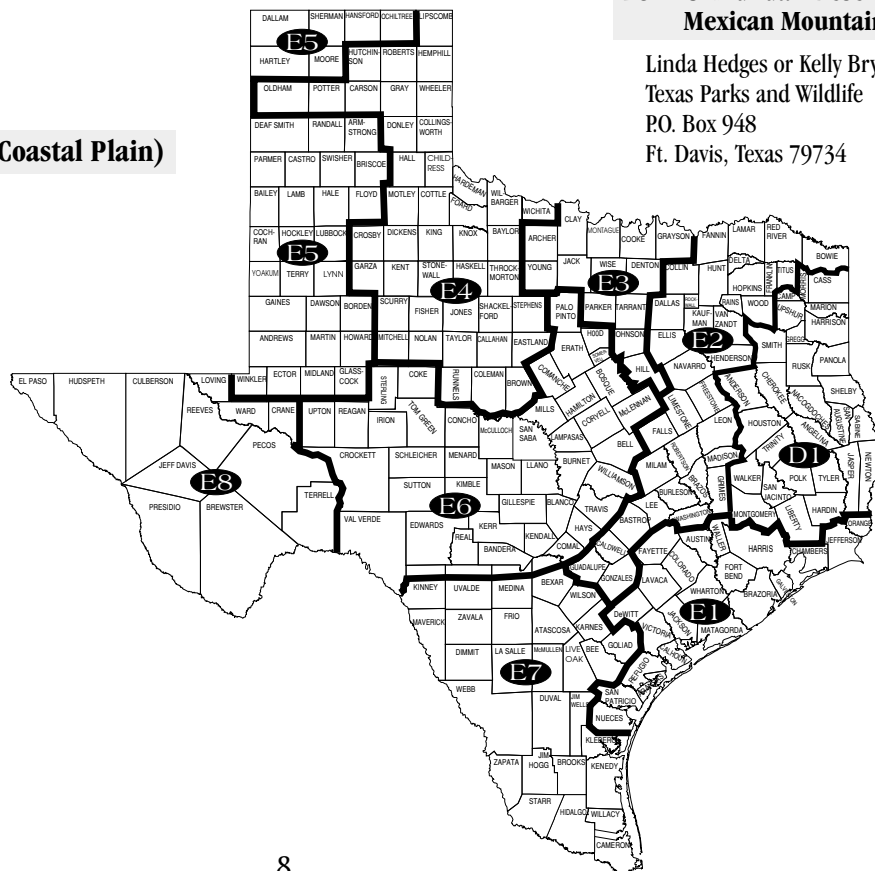

Bird Conservation in the Classroom: The Trans-Pecos Wild Bird Trunk

by Shelly Scroggs, Wild Bird Trunk Coordinator

A great new Texas Partners in Flight Wild Bird Trunk has been completed for the Trans-Pecos region. Six trunks (“foot lockers”) full of fun and interpretive materials and bird-related items were developed for use throughout West Texas and parts of Mexico. These trunks contain educational materials, science and social studies curricula, and classroom and field projects aimed at grades 4 through 6. Items such as birding field guides, bird conservation activity books (including a raptor booklet in English and Spanish), posters, binoculars, and more are included in these trunks to help bring conservation into the classroom in a fun way. The Wild Bird Trunk promotes the ecological importance of resident and migratory landbirds to school-aged children, and hopefully, as a result, to their families. Using the tool of bird conservation, we hope to instill a sense of the importance of all factors in the environment to the ecosystem as a whole.



Shelly Scroggs, TX PIF's Wild Bird Trunk Coordinator, with one of the Trans-Pecos trunks.

These were made possible due to a generous TPWD Community Outdoor Outreach Grant. We are currently seeking additional funds to replicate this project in other regions of Texas. We hope to target South Texas, including the Lower Rio Grande Valley, and the Texas Coastal Prairies as soon as additional funds come in. The six trunks in the Trans-Pecos will act as models for future Wild Bird Trunks, although the trunks in each region will contain items geared specifically to its unique habitat and avifauna.

Schools in the Trans-Pecos have already been notified as to where to obtain their trunks, so if you or a friend is a fourth, fifth, or sixth grade teacher in West Texas who has not heard about this project, please contact these sites that “house” a trunk: Carol Ramos with Franklin Mountains State Park at 915-566-6441, Molly Yeager in Fort Stockton at 915-336-4040, Bonnie McKinney with TPWD in Marathon at 915-386-4529, Kelly Bryan with TPWD in Fort Davis at 915-426-3897, and Elizabeth Spence de Sellers in Sabinas, Coahuila, Mexico. We want everyone in the Trans-Pecos to benefit from this new and exciting project! Thanks to all who have helped!

Coffee For The Birds

Are you a coffee drinker needing that extra caffeine boost in the morning while birding? All coffee drinkers, especially birders, should know about and support “shade grown coffee.”

A typical coffee plantation was formerly a lush, tropical forest that was “slashed and burned” to make way for coffee beans; destroying the wintering habitat of many of our nesting warblers, vireos, etc. (not to mention the tropical residents). Other types of plantations retain the native canopy of trees and the coffee plants are planted underneath. This is what is meant by shade grown coffee. Birds benefit from this type of coffee farming.

Many coffee companies have been asked to sell this “bird friendly” coffee, but because it makes the other coffees look bad, they avoid it all together. Doesn't this sound like the dolphin and canned tuna issue years ago?

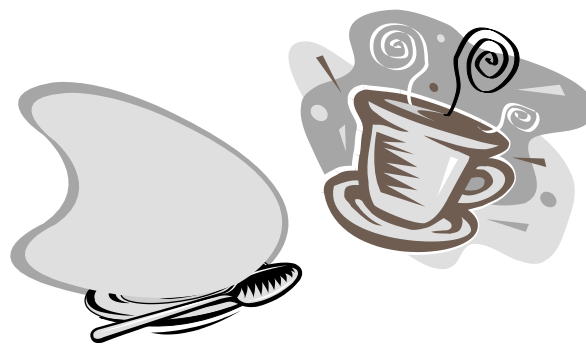

For more information on how to get this coffee, you can call Sanctuary Coffees by Counter Culture Coffee Roasters at 1-888-238-JAVA or Thanksgiving Coffee Co. at 1-800-648-6491, or try the Atlanta Audubon Society at 770-955-4111 or check their Web site at www.hitt.com/~jhitt/audubon.htm. Many Wild Birds Unlimited stores, and possibly Whole Foods in the near future, are carrying this special coffee. Why don't you try some—the American Redstarts and Wilson's Warblers will thank you.

A Citizen Science Program: "Project Prairie Birds"

Some of PIF's highest priority birds (due to drastic population declines) are the grassland birds such as Le Conte's and Henslow's Sparrows. Henslow's Sparrows are true skulkers that are more common as a wintering species in the eastern third of Texas than most people realize. This sparrow once bred in the tallgrass prairies of the Upper Texas Coast (present day Houston) until about 1982-83.

David and Mimi Wolf of Nacogdoches began to notice a more prevalent winter Henslow's Sparrow population in eastern Texas than was previously thought. They began searching the bluestem fields of eastern Texas in the early 1990s and discovered numerous birds. The Henslow's Sparrow has since been removed from the TBRC Review List.

Texas Partners In Flight, the Gulf Coast Bird Observatory, the USFWS, the OG of Houston and others are partnering together to organize PROJECT PRAIRIE BIRDS; soliciting the help of area birders to help determine the abundance and habitat preferences for all grassland bird species on the upper Texas coast. To launch the project, a Grassland Bird Workshop was held at Armand Bayou Nature Center in Clear Lake on January 31, 1998. Over 30 people attended this workshop where details of the project were discussed. Ross Carrie, an avian researcher with the Dept. of Defense at Fort Polk, LA, brought his field crew and demonstrated the methods they use for collecting bird and vegetation data; these methods are fairly standardized. By next fall, the partnership plans to publish an instruction guide describing proper field methods of conducting research on grassland birds. The intention is that all researchers currently conducting, or planning to conduct, research on grassland birds should standardize data collection to better address landscape-level problems. On the upper Texas coast, where this project is originating, it is obvious that the loss of large, contiguous prairie systems maintained by frequent fire is the



Henslow's Sparrow in Nacogdoches County, found by the Wolf's in winter 1995. Photo by Cliff Shackelford.

main reason for bird declines in that area. PROJECT PRAIRIE BIRDS can be replicated in other ecoregions of the state or elsewhere in the country.

There is hope that a seasonal coordinator for this project will be funded and hired before the migration of fall 1998. Please contact the TX PIF State Office if you'd like more information on how you can get involved with PROJECT PRAIRIE BIRDS. You can assist with answering questions regarding why these species are so sensitive and declining in number. With your help, hopefully a solution can be found to reverse the decline in population.

Hummingbird Roundup

by Christina McCain, Coordinator of the Hummingbird Roundup

The Texas Hummingbird Roundup Backyard Survey began its fifth year in January 1998. This five-year study was designed to obtain new information on hummingbird distribution and behavior in the State of Texas through the observations of volunteer participants.

In the last four years we've gathered some exciting new information on overwintering hummers in Texas, albino bird sightings, hummingbird habits, and expanded ranges. We still have one more year, so if you are not already a participant please join us!

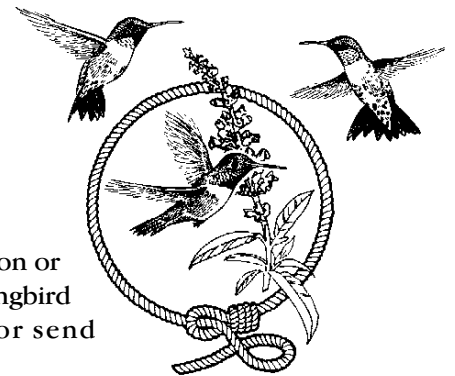

For more information or to join the Hummingbird Roundup, write or send \$6.00 to:

Texas Hummingbird Roundup
4200 Smith School Rd.
Austin, Texas 78744
christina.mccain@tpwd.state.tx.us
512-398-4470

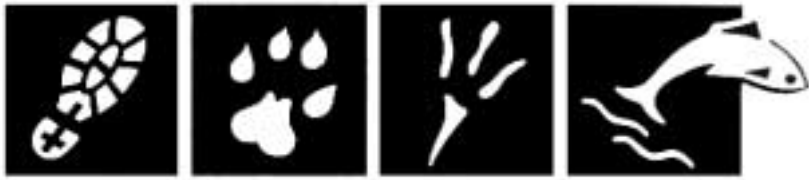

Teaming With Wildlife

*written by John Herron,
Nongame and Urban Program Director*

Teaming With Wildlife (hereafter "TEAMING") is a proposed excise tax (user-fee) that will add less than 5% to the price of sporting goods. This includes many birding-related equipment: binoculars, film, tents, bird seed/feeders, canoes, sleeping bags, sport utility vehicles, etc.. Annually, this will raise \$350 million nationally (over \$17 million for Texas alone) which will go back to each state's wildlife agency. The money that comes to Texas will support various projects that will benefit nongame birds and birders, state parks and educational programs, as well as numerous other nongame efforts (like lizards, butterflies, etc).

While the list of excise tax items seems large, the actual impact to users would be fairly small. For example, a \$100 tent, that wholesales for \$50, would include a user fee of \$2.50. The amount of the user fee will be based on a percentage of the manufacturer's price of the product, ranging from a low of 0.25% to a maximum of 5%.

There are a number of renowned companies supporting this proposal, including Swarovski Optic, Zeiss, American Agco (bird seed), Petco, etc. There are over 2,000 other supporters nationally (obviously too many to list here).

The point of the legislation is that over 160 million Americans enjoy the outdoors in activities including backpacking, hiking, camping, canoeing, photography, mountain biking, birding and backyard wildlife viewing; that number is much greater than those who hunt and fish combined. Through TEAMING, these users would help finance conservation efforts which would benefit the animals and wild places we are all interested in. The projected \$350 million in annual revenue would enable states to address declines of such wildlife as songbirds, wading birds, reptiles and amphibians, and respond to the escalating public demand for trails and other recreational opportunities on state lands.

Hunters and anglers pay a similar tax on hunting and fishing equipment, and also help finance wildlife conservation through hunting and fishing licenses and stamps. That money goes back into the field, thus benefitting game species. Many of our wetlands are created or maintained thanks to this kind of funding, which benefits ducks, as well as shorebirds, wading birds, marsh-inhabiting birds, and others which tag along. Birders, like hunters and anglers, need to pay to support their passion!

A coalition of conservation groups, including the International Assoc. of Fish and Wildlife Agencies, National Wildlife Federation, National Audubon Society and The Wildlife Society hope to introduce TEAMING legislation this year.

There has never been a conservation initiative that has had such early support. A broad coalition of outdoor enthusiasts is working to expand on this proven approach, to address the broader challenges of today. The coalition of over 2,000 conservation organizations and businesses has created this proposal. This coalition includes over 375 outdoor businesses as well as the nation's most prominent conservation and outdoor groups.

There is still major opposition from several recreation equipment groups and manufacturers. The question is, will Congress listen to trade associations for the users? There is probably 80% support among most user groups. But there is even some limited opposition from a few conservationists and wildlife professionals: some who are nervous "hook-and-bullet types", some who are anti-tax, but mostly from folks who are so strongly "environmental" that they don't understand or don't support wildlife agencies.

Interestingly, the National Wild Turkey Federation is one of the strongest and most active coalition members. They realize that: 1) TEAMING benefits all wildlife and hunters support this, and 2) TEAMING will also benefit hunters (just like birders in Texas benefit from "duck money" at Anahuac NWR, Laguna Atascosa NWR, etc.).

What can you do to help? Ask your supplier of outdoor equipment if they support TEAMING and only make purchases from those that do support it. Coleman and REI, to name a few, were early opponents of TEAMING. REI has since made the sly move into "neutral status." Support those companies that support birds!

For more information on TEAMING, visit the web site:
<http://www.teaming.com>

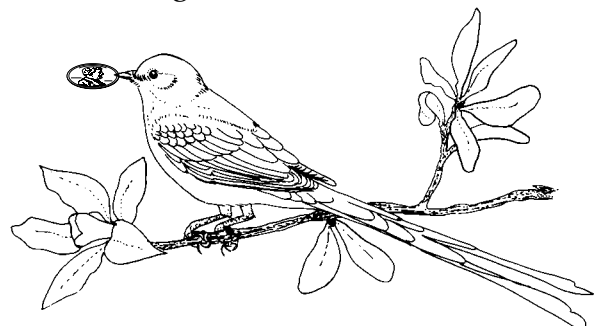

National PIF Awards In Texas

Texas has two recipients of National Partners In Flight (PIF) Awards. The John G. and Marie Stella Kenedy Memorial Foundation will receive the 1997 Land Steward Award for their effort in bird conservation. This is due to the hard work of people like Joe Keepers (Land Manager), Cecilia Riley and Madge Lindsay (Technical Guidance) and all the birders and tour leaders (Brush Freeman, Petra Hockey, John Arvin, etc.) that have been conducting birding tours there. Frequent and consistent nature tours to the ranch show the Kenedy Memorial Foundation (and surrounding ranchers) that birders are willing to pay to see great birds. Money that can further benefit habitat restoration and preservation for future birds and future tours. Economics can result in conservation!

Madge Lindsay of the Nongame and Urban Program at TPWD is the other recipient and will receive the 1997 Public Awareness Award for all her work with bird conservation (the Birding Trail, the Birding Classic, the forthcoming World Birding Center, etc.). Her efforts cannot be matched and she has been the "loudest and best voice" in the bird conservation business. Other states are following her lead by installing birding trails, initiating birding competitions and really pushing nature tourism. The birds will benefit!

These awards are of national recognition. Awards will be presented in Orlando, Florida in March 1998 at the North American Wildlife Resources Conference. You can contact the State Coordinator of TX PIF if you'd like to nominate someone for future PIF Awards. A letter explaining major bird conservation accomplishments will be necessary by following some brief guidelines ("major" means of landscape-level importance).



Steve Gast of Phillips Petroleum formerly of Houston, but currently of Bartlesville, OK standing next to the sign for the new woods named in his honor in High Island, Texas at the 20 April 1997 dedication ceremony. Photo by Robert A. Behrstock.



Ted Eubanks of Austin and TX PIF's Board President with Winnie Burkett of the Houston Audubon Society at the dedication ceremony in High Island, Texas, 20 April 1997. These woods were dedicated in recognition of the hard work Ted has done in the field of bird conservation in the area and elsewhere. Photo by Robert A. Behrstock.

The TX PIF Board of Directors

Much thanks to these major contributors:

Ted Eubanks, President; Bryan Hale, Treasurer;
John Herron, Gary Graham, and Madge Lindsay

We will be adding new members to the Board since several key members recently moved out of Texas.

Communication

Thanks to Ted Eubanks and Audubon for establishing the first three listserves. To join the popular birding chat group **TexBirds** listserv with over 500 subscribers, send a message to: LISTSERV@LIST.AUDUBON.ORG with the following one-line command, SUBSCRIBE TEXBIRDS your name.

To join its "sister" conservation chat group, **TexGeneral**, send a message to: LISTSERV@LIST.AUDUBON.ORG with the following one-line command; SUBSCRIBE TX-GENERAL your name.

To join the newly-established (Jan. 1998) Mexican birds chat group called **Mex-Bird**, send the following message to LISTSERV@LIST.AUDUBON.ORG (no subject required): SUBSCRIBE MEX-BIRD "Yourfirstname Yourlastname"

To join the **Southeast Partners In Flight Working Group's** listserv (a regional bird conservation, internet chat group based at the University of Arkansas by Dr. Kim Smith with over 125 subscribers), send an e-mail to:

ADDRESS: LISTSERV@UAFSYSB.UARK.EDU
(all caps OR all lower case)

SUBJECT: (leave blank)

TEXT: subscribe separt-1 (all lower case; the last character is the letter L as in Listserv)
John Birder (your name)

Recent TX PIF Pamphlets and Brochures

Available:

Partnering with Texas Partners In Flight
(The Mission of TX PIF)
The Birding Festivals of Texas for 1998
The Woodpeckers of Eastern Texas, 2nd edition (with
Melissa Parker, Resource Protection, TPWD)
Wild Bird Trunk Teacher's Activity Guide
for the Trans-Pecos (available only with a Trunk)
The Birder's Directory for Texas: Birding Clubs,
Bird Banders and Submitting Bird Sightings
The Austin Birding Guide (with Travis Audubon Society
and UT-Austin Geography Students)
Swallow-tailed Kite Monitoring Form (with Joe Hamrick of
Temple-Inland Forest, Ray Brown and Dawn Carrie of
USFS, and Ross Carrie of Raven Environmental)
The Flight STAR Program
How Can You Assist Migratory Landbirds?

In Prep:

A Landowner's Guide to the Red-cockaded Woodpecker:
Living in Harmony (with Jeff Reid of USFS and Ricky
Maxey of Endangered Resources, TPWD)

Be A Partner In Flight, The Texas Way!



TX PIF is a 501(c)(3) organization, and contributions are tax-deductible to the extent allowed by federal law.

For contributions of \$25 or more, we will send you two free copies of the SE PIF poster mentioned in this newsletter. For contributions of \$50 or more, we will send you five posters and a copy of the *Species Priority List for Bird Conservation*, edited by Cecilia M. Riley (1996; 111 pp.).

PIF Meetings



The third **Birdlife of Texas Symposium** will be scheduled sometime in early 1999 in Austin. The theme of this meeting will be regional bird conservation that can be accomplished on the ground through proper management, nature tourism, landowner incentives, etc. The first Birdlife of Texas meeting was held in the 1950s in San Antonio and was organized by H. C. Oberholser. The second Birdlife of Texas was held in Austin in November 1996 and was organized by Texas Partners In Flight. Over 100 people attended in 1996; please stay tuned so you can attend this important meeting in 1999.

A **Southeastern Partners In Flight Meeting** is scheduled for October 1998 in Orlando, Florida in conjunction with the Southeastern Association of Fish and Wildlife Agencies.

Southeastern PIF Poster

TX PIF has assumed responsibility for designing and producing a color poster highlighting 25 high priority migratory landbirds of the Southeastern U.S. Species included are Prothonotary and Swainson's warblers, Swallow-tailed Kite, Henslow's and Bachman's sparrows and Burrowing Owl, to name a few. Almost 90,000 posters were printed in early March, 1998 and have content appropriate for any interest group—from land managers to classrooms. The text was written by Chuck Hunter (SE PIF-GA), Cliff Shackelford (TX PIF), Madge Lindsay (TPWD) and Sandra Skrei (formerly with the National Audubon Society-TX). Lisa Gericke (Westvaco-KY) helped get the project started. Partners (in no particular order) that contributed time and money to this poster include: The Southeast Association of Fish and Wildlife Agencies; U.S. Fish and Wildlife Service; Texas Parks and Wildlife's Nongame and Urban Program; Partners In Flight; Southeast Working Group of Partners In Flight; Fish and Wildlife Foundation; Texas Partners In Flight; Westvaco; Willamette Industries, Inc.; Weyerhaeuser; Tennessee Conservation League and the U.S. Forest Service.

This poster is informative as well as beautiful; the artwork is superbly done by wildlife artist Michelle Davis of Mississippi. Orders are being taken for posters in multiples of 100 with that being the minimum. Please contact the TX PIF office for availability and price.

With full text on back of poster



Other Conservation Initiatives

A Conservation Plan Already on the Ground and Running: The Texas Wetlands Conservation Plan

by Julie Anderson, State Wetlands Planner, Texas Parks and Wildlife

Texas Parks and Wildlife, in cooperation with numerous entities, has recently completed the Texas Wetlands Conservation Plan (the Plan). The Plan focuses on non-regulatory, voluntary approaches to conserving Texas' wetlands. Its primary contributions to wetlands conservation include:

- Enhancing the landowner's ability to use existing incentive programs and other land use options through outreach and assistance;
- Developing and encouraging land management options that provide an economic incentive for conserving existing wetlands or restoring former ones;
- Coordinating regional wetlands conservation efforts, including mitigation and restoration.

Due to the extensive size and physiography of Texas, a "regional" approach was used to best characterize the diverse wetlands needs and resources of Texas. Three Regional Advisory Groups, one each in East Texas, the Panhandle, and the Gulf Coast, were formed to identify regional or statewide issues associated with conserving Texas wetlands, and to develop recommendations and proposals for action to address those issues. These results form the core of the Texas Wetlands Conservation Plan. These regions were selected because each represents a large wetland complex, and each has a distinct socioeconomic structure and specific land use.

The Regional Advisory Groups met over the course of one year to discuss solutions to five general categories of wetlands issues that they identified: education, economic incentives, conservation, private ownership, and

governmental relations. Information from the three groups was combined into a single plan.

The Texas Parks and Wildlife Commission approved a resolution on April 17, 1997 supporting the Texas Wetlands Conservation Plan and the Governor of Texas signed it in July, 1997. The following groups were all represented on one or more of the Plan's advisory groups and gave their formal support for the Plan: Texas Farm Bureau, Texas Chemical Council, Wetland Habitat Alliance of Texas, Texas and Southwestern Cattle Raisers Association, Champion International Corporation, Texas Committee on Natural Resources, Texas Utilities Services, Inc., Ducks Unlimited, The Nature Conservancy of Texas, Texas Grain Sorghum Producers, Texas Rural Development Council, Big Thicket Association, International Paper, Texas Cattle Feeders Association, Texas General Land Office, Texas Natural Resources Conservation Commission, Texas Forest Service, Texas Water Development Board, Texas Agricultural Extension Service, Texas Department of Transportation, Texas Department of Agriculture, Texas State Soil and Water Conservation Board, Natural Resources Conservation Service, U.S. Fish and Wildlife Service, and many private landowners.

Numerous implementation efforts are underway, including the Wetlands Project Site Registry. The Registry acts as a broker linking wetlands owners with those who wish, or need, to restore habitat. Texas once boasted 16 million acres of wetlands; currently there are only eight million acres. These wetlands projects are funded by an EPA grant and by Texas Parks and Wildlife. To contact the State Wetlands Planner, call Julie Anderson at 512-389-4328.



Chimney Swift Conservation

by Paul and Georgan Kyle

In January of 1989, Georgan and I built two wooden towers which were designed to attract nesting and roosting Chimney Swifts. They are 22' tall, 18" x 18" inside and attached to our two story house in northwestern Travis County. In late March of that year a pair moved into one of the towers and raised a family. By October a roost of more than 60 swifts were spending each night in the tower. The next year, both towers had nests and the fall roost contained more than 100 swifts. We now enjoy the company of Chimney Swifts every year.

In 1995 we established the North American Chimney Swift Research Project. The goals of the project are to: identify and monitor existing nest sites; design, construct and monitor new sites; and raise public awareness about Chimney Swifts conservation. Presently we have over 200 individuals and groups on our mailing list, and our Research Associates have constructed more than 50 Chimney Swift towers of various designs in 15 states.

For more information or to become a Research Associate, contact: Paul and Georgan Kyle
Driftwood Wildlife Association
1206 West 38th, Suite 1105
Austin, Texas 78705
E-mail: DWA@concentric.net
Web site at www.concentric.net/~DWA

Research Associates receive the Newsletter "Chaetura," used as an aid for monitoring forms and plans for several different sizes and styles of Chimney Swift towers.

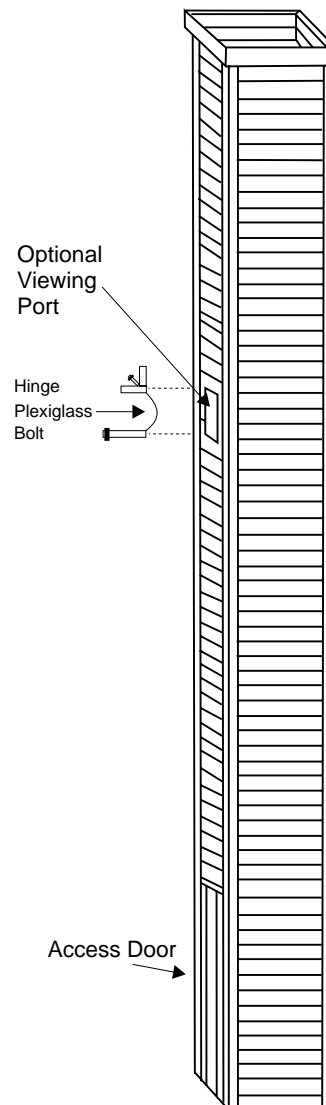
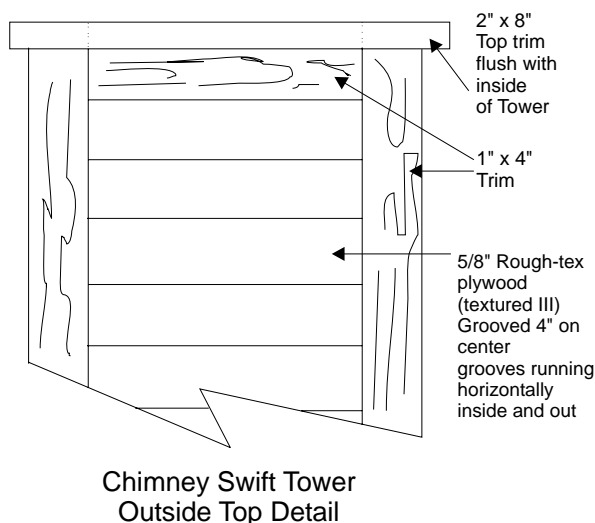
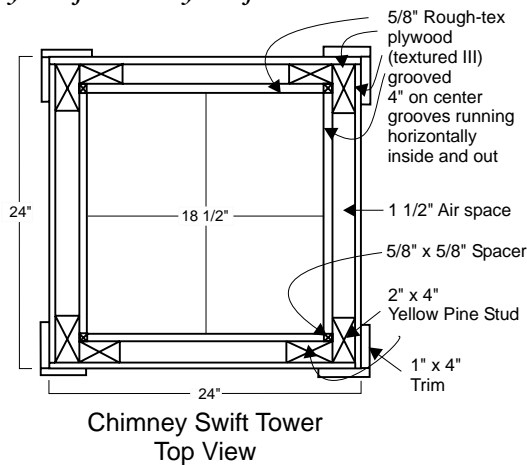



Texas Partners in Flight
Texas Parks and Wildlife
4200 Smith School Road
Austin, Texas 78744

PWD BR W7000-233 (3/98)



NEWSLETTER

flyway

Texas Partners In Flight